

100343

100343 Low Power 8-Bit Latch



Literature Number: SNOS114

100343 Low Power 8-Bit Latch

General Description

The 100343 contains eight D-type latches, individual inputs, (D_n), outputs (Q_n), a common enable pin (\bar{E}), and a latch enable pin (\overline{LE}). A Q output follows its D input when both \bar{E} and \overline{LE} are LOW. When either \bar{E} or \overline{LE} (or both) are HIGH, a latch stores the last valid data present on its D input prior to \bar{E} or \overline{LE} going HIGH.

The 100343 outputs are designed to drive a 50 Ω termination resistor to -2.0V. All inputs have 50 k Ω pull-down resistors.

Features

- Low power operation
- 2000V ESD protection
- Voltage compensated operating range = -4.2V to -5.7V
- Available to MIL-STD-883

Logic Symbol

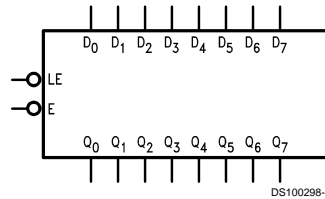

Pin Names	Description
D_0 - D_7	Data Inputs
\bar{E}	Enable Input
\overline{LE}	Latch Enable Input
Q_0 - Q_7	Data Outputs
NC	No Connect

Connection Diagrams

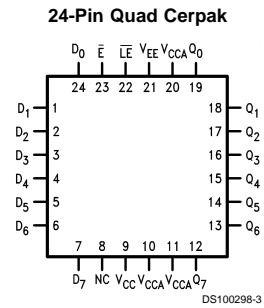
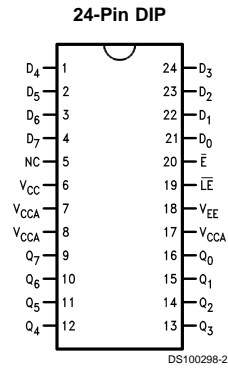

Logic Diagram

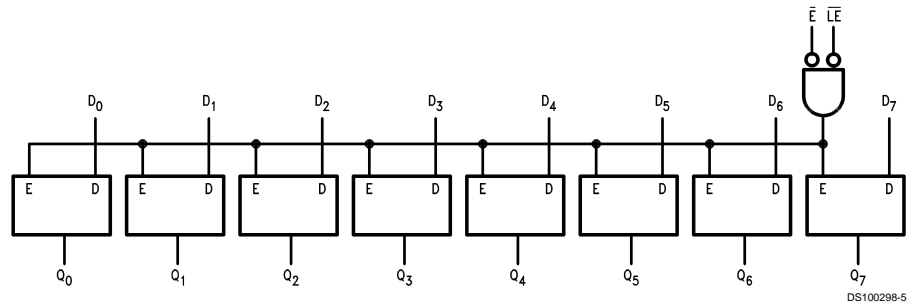

Truth Table

Inputs			Outputs
D_n	\bar{E}	\bar{LE}	Q_n
L	L	L	L
H	L	L	H
X	H	X	Latched (Note 1)
X	X	H	Latched (Note 1)

H = HIGH voltage level

L = LOW voltage level

X = Don't care

Note 1: Retains data present before either \bar{LE} or \bar{E} went HIGH

Absolute Maximum Ratings (Note 2)

If Military/Aerospace specified devices are required, please contact the National Semiconductor Sales Office/Distributors for availability and specifications.

Storage Temperature (T_{STG})	-65°C to +150°C
Maximum Junction Temperature (T_J)	
Ceramic	+175°C
V_{EE} Pin Potential to Ground Pin	-7.0V to +0.5V
Input Voltage (DC)	V_{EE} to +0.5V
Output Current (DC Output HIGH)	-50 mA
ESD (Note 3)	≥2000V

Recommended Operating Conditions

Case Temperature (T_C)	
Military	-55°C to +125°C
Supply Voltage (V_{EE})	-5.7V to -4.2V

Note 2: Absolute maximum ratings are those values beyond which the device may be damaged or have its useful life impaired. Functional operation under these conditions is not implied.

Note 3: ESD testing conforms to MIL-STD-883, Method 3015.

Military Version DC Electrical Characteristics

$V_{EE} = -4.2V$ to $-5.7V$, $V_{CC} = V_{CCA} = GND$, $T_C = -55°C$ to $+125°C$

Symbol	Parameter	Min	Max	Units	T_C	Conditions	Notes	
V_{OH}	Output HIGH Voltage	-1025	-870	mV	0°C to +125°C	$V_{IN} = V_{IH}$ (Max) or V_{IL} (Min)	Loading with 50Ω to -2.0V	1, 2, 3
		-1085	-870	mV	-55°C			
V_{OL}	Output LOW Voltage	-1830	-1620	mV	0°C to +125°C			
		-1830	-1555	mV	-55°C			
V_{OHC}	Output HIGH Voltage	-1035		mV	0°C to +125°C	$V_{IN} = V_{IH}$ (Max) or V_{IL} (Min)	Loading with 50Ω to -2.0V	1, 2, 3
		-1085		mV	-55°C			
V_{OLC}	Output LOW Voltage		-1610	mV	0°C to +125°C			
			-1555	mV	-55°C			
V_{IH}	Input HIGH Voltage	-1165	-870	mV	-55°C to +125°C	Guaranteed HIGH Signal for All Inputs	1, 2, 3, 4	
V_{IL}	Input LOW Voltage	-1830	-1475	mV	-55°C to +125°C	Guaranteed LOW Signal for All Inputs	1, 2, 3, 4	
I_{IL}	Input LOW Current	0.50		μA	-55°C to +125°C	$V_{EE} = -4.2V$ $V_{IN} = V_{IL}$ (Min)	1, 2, 3	
I_{IH}	Input HIGH Current		240	μA	0°C to +125°C	$V_{EE} = -5.7V$ $V_{IN} = V_{IH}$ (Max)	1, 2, 3	
			340	μA	-55°C			
I_{EE}	Power Supply Current				-55°C to +125°C	Inputs Open	1, 2, 3	
		-100	-35	mA		$V_{EE} = -4.2V$ to $-4.8V$		
		-105	-35	mA		$V_{EE} = -4.2V$ to $-5.7V$		

Note 4: F100K 300 Series cold temperature testing is performed by temperature soaking (to guarantee junction temperature equals -55°C), then testing immediately without allowing for the junction temperature to stabilize due to heat dissipation after power-up. This provides "cold start" specs which can be considered a worst case condition at cold temperatures.

Note 5: Screen tested 100% on each device at -55°C, +25°C, and +125°C, Subgroups 1, 2, 3, 7, and 8.

Note 6: Sample tested (Method 5005, Table I) on each manufactured lot at -55°C, +25°C, and +125°C, Subgroups A1, 2, 3, 7, and 8.

Note 7: Guaranteed by applying specified input condition and testing V_{OH}/V_{OL} .

Military Version AC Electrical Characteristics

$V_{EE} = -4.2V$ to $-5.7V$, $V_{CC} = V_{CCA} = GND$

Symbol	Parameter	$T_C = -55°C$		$T_C = +25°C$		$T_C = +125°C$		Units	Conditions	Notes
		Min	Max	Min	Max	Min	Max			
t_{PLH}	Propagation Delay	0.50	2.70	0.50	2.30	0.50	2.80	ns	Figures 1, 2, 3	(Notes 8, 9, 10, 12)
t_{PHL}	D_n to Output									

Military Version AC Electrical Characteristics (Continued)

$V_{EE} = -4.2V$ to $-5.7V$, $V_{CC} = V_{CCA} = GND$

Symbol	Parameter	$T_C = -55^\circ C$		$T_C = +25^\circ C$		$T_C = +125^\circ C$		Units	Conditions	Notes
		Min	Max	Min	Max	Min	Max			
t_{PLH}	Propagation Delay	0.90	3.40	1.0	3.10	1.10	3.90	ns	Figures 1, 2, 3	(Notes 8, 9, 10, 12)
t_{PHL}	\overline{LE} , \overline{E} to Output									
t_{TLH}	Transition Time	0.40	2.50	0.40	2.40	0.40	2.70	ns	Figures 1, 3	(Note 11)
t_{THL}	20% to 80%, 80% to 20%									
t_s	Setup Time								Figures 1, 4	(Note 11)
	D_0-D_7	0.60		0.60		0.60		ns		
t_h	Hold Time								Figures 1, 4	(Note 11)
	D_0-D_7	1.50		1.50		1.70		ns		
$t_{pw(H)}$	Pulse Width HIGH								Figures 1, 4	(Note 11)
	\overline{LE} , \overline{E}	2.40		2.40		2.40		ns		

Note 8: F100K 300 Series cold temperature testing is performed by temperature soaking (to guarantee junction temperature equals $-55^\circ C$), then testing immediately after power-up. This provides "cold start" specs which can be considered a worst case condition at cold temperatures.

Note 9: Screen tested 100% on each device at $+25^\circ C$ temperature only, Subgroup A9.

Note 10: Sample tested (Method 5005, Table I) on each manufactured lot at $+25^\circ C$, Subgroup A9, and at $+125^\circ C$ and $-55^\circ C$ temperatures, Subgroups A10 and A11.

Note 11: Not tested at $+25^\circ C$, $+125^\circ C$, and $-55^\circ C$ temperature (design characterization data).

Note 12: The propagation delay specified is for single output switching. Delays may vary up to 300 ps with multiple outputs switching.

Test Circuitry

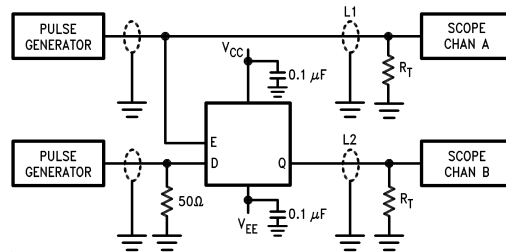

DS100298-6

Note 13: V_{CC} , $V_{CCA} = +2V$, $V_{EE} = -2.5V$

Note 14: L1 and L2 = equal length 50Ω impedance lines

$R_T = 50\Omega$ terminator internal to scope

Decoupling 0.1 μF from GND to V_{CC} and V_{EE}

All unused outputs are loaded with 50Ω to GND

$C_L =$ Fixture and stray capacitance ≤ 3 pF

FIGURE 1. AC Test Circuit

Switching Waveforms

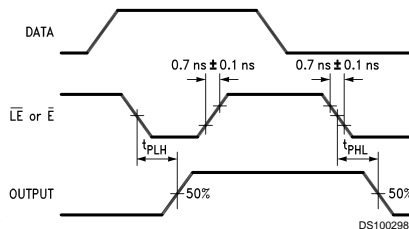

DS100298-7

FIGURE 2. Propagation Delays

Switching Waveforms (Continued)

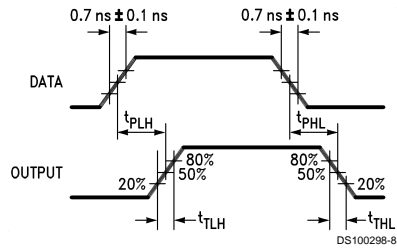

FIGURE 3. Propagation and Transition Times

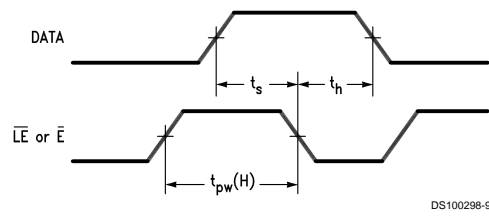
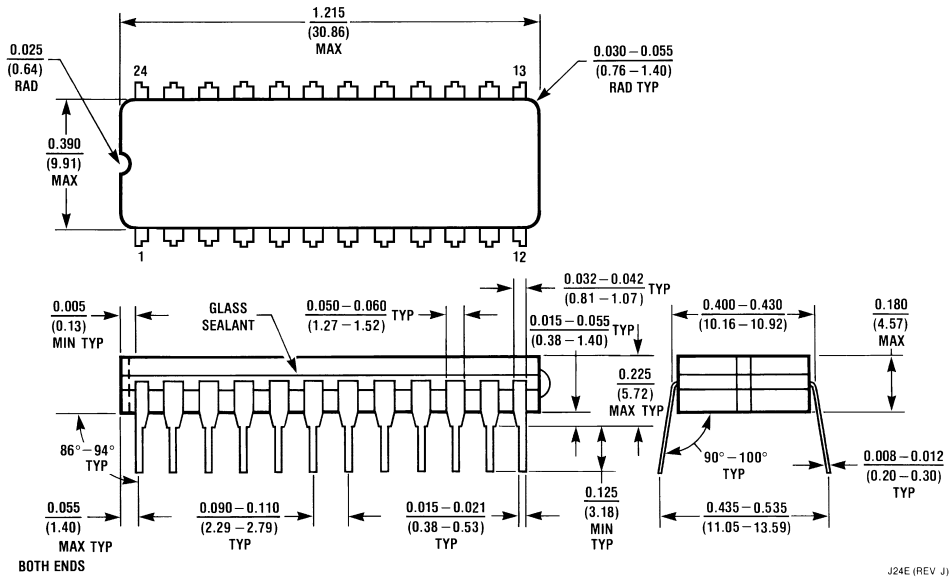

FIGURE 4. Setup, Hold and Pulse Width Times



Physical Dimensions inches (millimeters) unless otherwise noted



J24E (REV J)

24-Pin Ceramic Dual-In-Line Package (D)
NS Package Number J24E

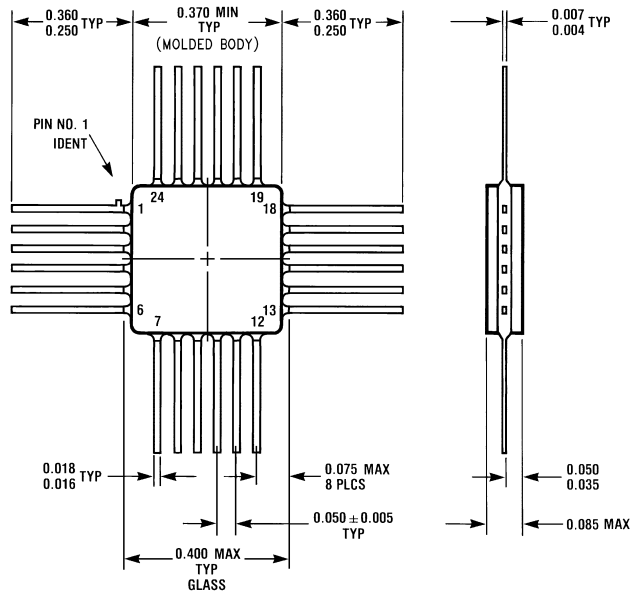

W24B (REV D)

24-Lead Quad Cerpak (F)
NS Package Number W24B

LIFE SUPPORT POLICY

NATIONAL'S PRODUCTS ARE NOT AUTHORIZED FOR USE AS CRITICAL COMPONENTS IN LIFE SUPPORT DEVICES OR SYSTEMS WITHOUT THE EXPRESS WRITTEN APPROVAL OF THE PRESIDENT OF NATIONAL SEMICONDUCTOR CORPORATION. As used herein:

1. Life support devices or systems are devices or systems which, (a) are intended for surgical implant into the body, or (b) support or sustain life, and whose failure to perform when properly used in accordance with instructions for use provided in the labeling, can be reasonably expected to result in a significant injury to the user.
2. A critical component in any component of a life support device or system whose failure to perform can be reasonably expected to cause the failure of the life support device or system, or to affect its safety or effectiveness.



National Semiconductor Corporation
Americas
Tel: 1-800-272-9959
Fax: 1-800-737-7018
Email: support@nsc.com

www.national.com

National Semiconductor Europe
Fax: +49 (0) 1 80-530 85 86
Email: europe.support@nsc.com
Deutsch Tel: +49 (0) 1 80-530 85 85
English Tel: +49 (0) 1 80-532 78 32
Français Tel: +49 (0) 1 80-532 93 58
Italiano Tel: +49 (0) 1 80-534 16 80

National Semiconductor Asia Pacific Customer Response Group
Tel: 65-2544466
Fax: 65-2504466
Email: sea.support@nsc.com

National Semiconductor Japan Ltd.
Tel: 81-3-5620-6175
Fax: 81-3-5620-6179

IMPORTANT NOTICE

Texas Instruments Incorporated and its subsidiaries (TI) reserve the right to make corrections, modifications, enhancements, improvements, and other changes to its products and services at any time and to discontinue any product or service without notice. Customers should obtain the latest relevant information before placing orders and should verify that such information is current and complete. All products are sold subject to TI's terms and conditions of sale supplied at the time of order acknowledgment.

TI warrants performance of its hardware products to the specifications applicable at the time of sale in accordance with TI's standard warranty. Testing and other quality control techniques are used to the extent TI deems necessary to support this warranty. Except where mandated by government requirements, testing of all parameters of each product is not necessarily performed.

TI assumes no liability for applications assistance or customer product design. Customers are responsible for their products and applications using TI components. To minimize the risks associated with customer products and applications, customers should provide adequate design and operating safeguards.

TI does not warrant or represent that any license, either express or implied, is granted under any TI patent right, copyright, mask work right, or other TI intellectual property right relating to any combination, machine, or process in which TI products or services are used. Information published by TI regarding third-party products or services does not constitute a license from TI to use such products or services or a warranty or endorsement thereof. Use of such information may require a license from a third party under the patents or other intellectual property of the third party, or a license from TI under the patents or other intellectual property of TI.

Reproduction of TI information in TI data books or data sheets is permissible only if reproduction is without alteration and is accompanied by all associated warranties, conditions, limitations, and notices. Reproduction of this information with alteration is an unfair and deceptive business practice. TI is not responsible or liable for such altered documentation. Information of third parties may be subject to additional restrictions.

Resale of TI products or services with statements different from or beyond the parameters stated by TI for that product or service voids all express and any implied warranties for the associated TI product or service and is an unfair and deceptive business practice. TI is not responsible or liable for any such statements.

TI products are not authorized for use in safety-critical applications (such as life support) where a failure of the TI product would reasonably be expected to cause severe personal injury or death, unless officers of the parties have executed an agreement specifically governing such use. Buyers represent that they have all necessary expertise in the safety and regulatory ramifications of their applications, and acknowledge and agree that they are solely responsible for all legal, regulatory and safety-related requirements concerning their products and any use of TI products in such safety-critical applications, notwithstanding any applications-related information or support that may be provided by TI. Further, Buyers must fully indemnify TI and its representatives against any damages arising out of the use of TI products in such safety-critical applications.

TI products are neither designed nor intended for use in military/aerospace applications or environments unless the TI products are specifically designated by TI as military-grade or "enhanced plastic." Only products designated by TI as military-grade meet military specifications. Buyers acknowledge and agree that any such use of TI products which TI has not designated as military-grade is solely at the Buyer's risk, and that they are solely responsible for compliance with all legal and regulatory requirements in connection with such use.

TI products are neither designed nor intended for use in automotive applications or environments unless the specific TI products are designated by TI as compliant with ISO/TS 16949 requirements. Buyers acknowledge and agree that, if they use any non-designated products in automotive applications, TI will not be responsible for any failure to meet such requirements.

Following are URLs where you can obtain information on other Texas Instruments products and application solutions:

Products

Audio	www.ti.com/audio
Amplifiers	amplifier.ti.com
Data Converters	dataconverter.ti.com
DLP® Products	www.dlp.com
DSP	dsp.ti.com
Clocks and Timers	www.ti.com/clocks
Interface	interface.ti.com
Logic	logic.ti.com
Power Mgmt	power.ti.com
Microcontrollers	microcontroller.ti.com
RFID	www.ti-rfid.com
OMAP Mobile Processors	www.ti.com/omap
Wireless Connectivity	www.ti.com/wirelessconnectivity

Applications

Communications and Telecom	www.ti.com/communications
Computers and Peripherals	www.ti.com/computers
Consumer Electronics	www.ti.com/consumer-apps
Energy and Lighting	www.ti.com/energy
Industrial	www.ti.com/industrial
Medical	www.ti.com/medical
Security	www.ti.com/security
Space, Avionics and Defense	www.ti.com/space-avionics-defense
Transportation and Automotive	www.ti.com/automotive
Video and Imaging	www.ti.com/video

TI E2E Community Home Page

e2e.ti.com

Mailing Address: Texas Instruments, Post Office Box 655303, Dallas, Texas 75265
Copyright © 2011, Texas Instruments Incorporated