

REF34xx Low-Drift, Low-Power, Small-Footprint Series Voltage Reference

1 Features

- Initial Accuracy: $\pm 0.05\%$ (Maximum)
- Temperature Coefficient : 6 ppm/ $^{\circ}\text{C}$ (Maximum)
- Operating Temperature Range: -40°C to $+125^{\circ}\text{C}$
- Output Current: ± 10 mA
- Low Quiescent Current: 95 μA (Maximum)
- Wide Input Voltage: 12 V
- Output 1/f Noise (0.1 Hz to 10 Hz): 3.8 $\mu\text{V}_{\text{pp}}/\text{V}$
- Excellent Long-Term Stability 25 ppm/1000 hrs
- Small Footprint 6-Pin SOT-23 Package

2 Applications

- Precision Data Acquisition Systems
- PLC Analog I/O Modules
- Field Transmitters
- Portable, Battery - Operated Equipment
- Industrial Instrumentation
- Test Equipment
- Power Monitoring
- LCR Meters

3 Description

The REF34xx device is a low temperature drift (6 ppm/ $^{\circ}\text{C}$), low-power, high-precision CMOS voltage reference, featuring $\pm 0.05\%$ initial accuracy, low operating current with power consumption less than 95 μA . This device also offers very low output noise of 3.8 $\mu\text{V}_{\text{pp}}/\text{V}$, which enables its ability to maintain high signal integrity with high-resolution data converters in noise critical systems. With a small SOT-23 package, REF34xx offers enhanced specifications and pin-to-pin replacement for MAX607x and ADR34xx. The REF34xx family is compatible to most of the ADC and DAC such as ADS1287, ADUCM360, ADS1112.

Stability and system reliability are further improved by the low output-voltage hysteresis of the device and low long-term output voltage drift. Furthermore, the small size and low operating current of the devices (95 μA) can benefit portable and battery-powered applications.

REF34xx is specified for the wide temperature range of -40°C to $+125^{\circ}\text{C}$. Contact the TI sales representative for additional voltage options.

Device Information⁽¹⁾

PART NAME	PACKAGE	BODY SIZE (NOM)
REF3425	SOT-23 (6)	2.90 mm x 1.60 mm
REF3430		
REF3433		
REF3440		
REF3450		

(1) For all available packages, see the orderable addendum at the end of the data sheet.

Simplified Schematic

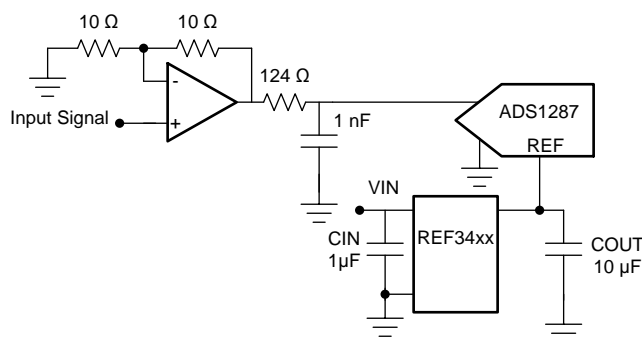

Copyright © 2017, Texas Instruments Incorporated

Dropout vs. Current Load Over Temperature

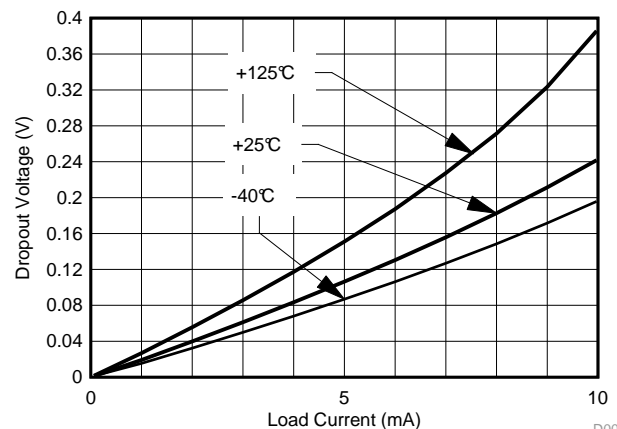

D001



Table of Contents

1 Features	1	9.1 Overview	15
2 Applications	1	9.2 Functional Block Diagram	15
3 Description	1	9.3 Feature Description	15
4 Revision History	2	9.4 Device Functional Modes	16
5 Device Comparison Table	3	10 Application and Implementation	17
6 Pin Configuration and Functions	3	10.1 Application Information	17
7 Specifications	4	10.2 Typical Application: Basic Voltage Reference Connection	17
7.1 Absolute Maximum Ratings	4	11 Power Supply Recommendations	19
7.2 ESD Ratings	4	12 Layout	20
7.3 Recommended Operating Conditions	4	12.1 Layout Guidelines	20
7.4 Thermal Information	4	12.2 Layout Example	20
7.5 Electrical Characteristics	5	13 Device and Documentation Support	21
7.6 Typical Characteristics	7	13.1 Documentation Support	21
8 Parameter Measurement Information	11	13.2 Receiving Notification of Documentation Updates	21
8.1 Solder Heat Shift	11	13.3 Community Resources	21
8.2 Long-Term Stability	12	13.4 Trademarks	21
8.3 Thermal Hysteresis	12	13.5 Electrostatic Discharge Caution	21
8.4 Power Dissipation	13	13.6 Glossary	21
8.5 Noise Performance	14	14 Mechanical, Packaging, and Orderable Information	21
9 Detailed Description	15		

4 Revision History

NOTE: Page numbers for previous revisions may differ from page numbers in the current version.

Changes from Revision A (December 2017) to Revision B	Page
• Added 2 new GPNS: REF3440 and REF3450	1
• Changed "Excellent Long-Term Stability 30 ppm/1000 hrs" to "Excellent Long-Term Stability 25 ppm/1000 hrs" in Features	1
• Changed TEST CONDITION for Output voltage accuracy row under ACCURACY AND DRIFT in Electrical Characteristics to "T _A = 25°C"	5
• Added "at 35°C" to TEST CONDITION and change "30 ppm" to "25 ppm" for Long-term stability row under HYSTERESIS AND LONG-TERM STABILITY in Electrical Characteristics ; add separate row for 1000 - 2000 hours at 35°C under same	5
• Changed "...typical drift value for the REF34xx is 30 ppm from 0 to 1000 hours" to "...typical drift value for the REF34xx is 25 ppm from 0 to 1000 hours" and changed Figure 25 in Long-Term Stability	12
• Changed "(as shown in Figure 26)" to " as shown in Figure 28 in last paragraph of 4-Wire Kelvin Connections	18

Changes from Original (September 2017) to Revision A	Page
• Added production release of 2 new output voltage option devices, REF3430 and REF3433	1

5 Device Comparison Table

PRODUCT	V _{OUT}
REF3425	2.5 V
REF3430	3 V
REF3433	3.3 V
REF3440	4.096 V
REF3450	5 V

6 Pin Configuration and Functions

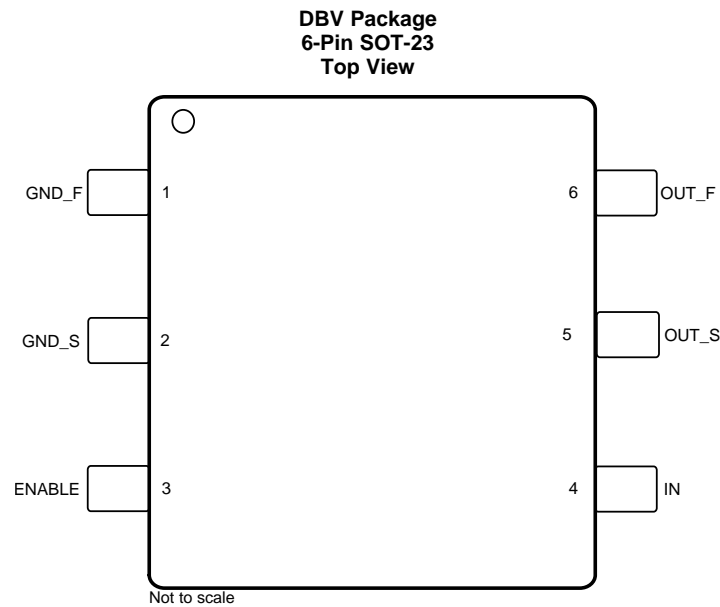

Pin Functions

PIN		TYPE	DESCRIPTION
NO.	NAME		
1	GND_F	Ground	Ground force connection
2	GND_S	Ground	Ground sense connection
3	ENABLE	Input	Enable connection. Enables or disables the device.
4	IN	Power	Input supply voltage connection
5	OUT_S	Output	Reference voltage output sense connection
6	OUT_F	Output	Reference voltage output force connection

7 Specifications

7.1 Absolute Maximum Ratings

 over operating free-air temperature range (unless otherwise noted)⁽¹⁾

		MIN	MAX	UNIT
Input voltage	IN	$V_{REF} + 0.05$	13	V
	EN	-0.3	IN + 0.3	
Output voltage	V_{REF}	-0.3	5.5	V
Output short circuit current			20	mA
Temperature	Operating, T_A ⁽²⁾	-55	150	°C
	Storage T_{stg}	-65	170	

- (1) Stresses beyond those listed under *Absolute Maximum Ratings* may cause permanent damage to the device. These are stress ratings only, which do not imply functional operation of the device at these or any other conditions beyond those indicated under *Recommended Operating Conditions*. Exposure to absolute-maximum-rated conditions for extended periods may affect device reliability.
- (2) By design, the device is guaranteed functional over the operating temperature of -55°C to 150°C.

7.2 ESD Ratings

		VALUE	UNIT
$V_{(ESD)}$ Electrostatic discharge	Human-body model (HBM), per ANSI/ESDA/JEDEC JS-001 ⁽¹⁾	±2500	V
	Charged-device model (CDM), per JEDEC specification JESD22-C101 ⁽²⁾	±1500	

- (1) JEDEC document JEP155 states that 500-V HBM allows safe manufacturing with a standard ESD control process.
- (2) JEDEC document JEP157 states that 250-V CDM allows safe manufacturing with a standard ESD control process.

7.3 Recommended Operating Conditions

over operating free-air temperature range (unless otherwise noted)

		MIN	NOM	MAX	UNIT
IN	Supply input voltage ($I_L = 0$ mA, $T_A = 25^\circ\text{C}$)	$V_{REF} + V_{DO}$ ⁽¹⁾		12	V
EN	Enable voltage	0		IN	V
I_L	Output current	-10		10	mA
T_A	Operating temperature	-40	25	125	°C

- (1) Dropout voltage

7.4 Thermal Information

THERMAL METRIC ⁽¹⁾		REF34xx	UNIT
		DBV (SOT-23)	
		6 PINS	
$R_{\theta JA}$	Junction-to-ambient thermal resistance	185	°C/W
$R_{\theta JC(top)}$	Junction-to-case (top) thermal resistance	156	°C/W
$R_{\theta JB}$	Junction-to-board thermal resistance	29.6	°C/W
Ψ_{JT}	Junction-to-top characterization parameter	33.8	°C/W
Ψ_{JB}	Junction-to-board characterization parameter	29.1	°C/W
$R_{\theta JC(bot)}$	Junction-to-case (bottom) thermal resistance	N/A	°C/W

- (1) For more information about traditional and new thermal metrics, see the [Semiconductor and IC Package Thermal Metrics](#) application report.

7.5 Electrical Characteristics

At $T_A = 25^\circ\text{C}$ unless otherwise noted.

PARAMETER		TEST CONDITIONS	MIN	TYP	MAX	UNIT	
ACCURACY AND DRIFT							
Output voltage accuracy		$T_A = 25^\circ\text{C}$	-0.05%		0.05%		
Output voltage temperature coefficient ⁽¹⁾		$-40^\circ\text{C} \leq T_A \leq 125^\circ\text{C}$		2.5	6	ppm/ $^\circ\text{C}$	
LINE AND LOAD REGULATION							
$\Delta V_{(O\Delta V_{IN})}$ Line regulation ⁽²⁾	$V_{IN} = 2.55\text{ V to }12\text{ V}, T_A = 25^\circ\text{C}$		2			ppm/V	
	$V_{IN} = V_{REF} + V_{DO}$ ⁽³⁾ to 12 V, $-40^\circ\text{C} \leq T_A \leq 125^\circ\text{C}$		15				
$\Delta V_{(O\Delta I_L)}$ Load regulation ⁽²⁾	$I_L = 0\text{ mA to }10\text{ mA}, V_{IN} = 3\text{ V}, T_A = 25^\circ\text{C}$	Sourcing	20			ppm/mA	
		Sourcing	30				
	$I_L = 0\text{ mA to }-10\text{ mA}, V_{IN} = V_{REF} + V_{DO}$ ⁽⁴⁾ , $T_A = 25^\circ\text{C}$	Sinking	REF3425	40			
			REF3430	43			
			REF3433	48			
			REF3440	60			
			REF3450	70			
	$I_L = 0\text{ mA to }-10\text{ mA}, V_{IN} = V_{REF} + V_{DO}$ ⁽⁴⁾ , $-40^\circ\text{C} \leq T_A \leq 125^\circ\text{C}$	Sinking	REF3425	70			
			REF3430	75			
			REF3433	84			
REF3440			98				
REF3450			140				
I_{SC} Short-circuit current (Output shorted to ground)	$V_{REF} = 0, T_A = 25^\circ\text{C}$			18	22	mA	
NOISE							
e_n p-p Output voltage noise ⁽⁵⁾	$f = 0.1\text{ Hz to }10\text{ Hz}$		5			$\mu\text{V p-p/V}$	
	$f = 0.1\text{ Hz to }10\text{ Hz}$ (REF3440 and REF3450)		3.8				
	$f = 10\text{ Hz to }10\text{ kHz}$		24			$\mu\text{V rms}$	
e_n Output voltage noise density	$f = 1\text{ kHz}$		0.25			ppm/ $\sqrt{\text{Hz}}$	
	$f = 1\text{ kHz}$ (REF3440 and REF3450)		0.2				
HYSTERESIS AND LONG-TERM STABILITY							
Long-term stability ⁽⁶⁾	0 - 1000 hours at 35°C		25			ppm	
	1000 - 2000 hours at 35°C		10				
Output voltage hysteresis ⁽⁷⁾	$T_A = 25^\circ\text{C to }-40^\circ\text{C to }125^\circ\text{C to }25^\circ\text{C}$, Cycle 1		30			ppm	
	$T_A = 25^\circ\text{C to }-40^\circ\text{C to }125^\circ\text{C to }25^\circ\text{C}$, Cycle 2		10				
TURNON							
t_{ON} Turnon time	0.1% of output voltage settling, $C_L = 10\ \mu\text{F}$, REF34xx		2.5			ms	
CAPACITIVE LOAD							
C_L Stable output capacitor value	$-40^\circ\text{C} \leq T_A \leq 125^\circ\text{C}$		0.1		10	μF	

- (1) Temperature drift is specified according to the box method. See [Feature Description](#) for more details.
- (2) The ppm/V and ppm/mA in line and load regulation can be also expressed as $\mu\text{V/V}$ and $\mu\text{V/mA}$.
- (3) The dropout voltage in line regulation test condition is 50 mV.
- (4) The dropout voltage in test condition is 500 mV.
- (5) The peak-to-peak noise measurement procedure is explained in more detail in [Noise Performance](#).
- (6) Long-term stability measurement procedure is explained in more in detail in [Long-Term Stability](#).
- (7) The thermal hysteresis measurement procedure is explained in more detail in [Thermal Hysteresis](#).

Electrical Characteristics (continued)

 At $T_A = 25^\circ\text{C}$ unless otherwise noted.

PARAMETER		TEST CONDITIONS		MIN	TYP	MAX	UNIT
OUTPUT VOLTAGE							
V_{REF}	Output voltage	REF3425			2.5		V
		REF3430			3		V
		REF3433			3.3		V
		REF3440			4.096		V
		REF3450			5		V
POWER SUPPLY							
V_{IN}	Input voltage			$V_{REF} + V_{DO}$		12	V
I_L	Output current capacity	$V_{IN} = V_{REF} + V_{DO}^{(4)}$ to 12 V	Sourcing	10			mA
		$V_{IN} = V_{REF} + V_{DO}^{(4)}$ to 12 V	Sinking	-10			
I_Q	Quiescent current	$-40^\circ\text{C} \leq T_A \leq 125^\circ\text{C}$	Active mode		72	95	μA
		$-40^\circ\text{C} \leq T_A \leq 125^\circ\text{C}$	Shutdown mode		2.5	3	
V_{DO}	Dropout voltage	$I_L = 0 \text{ mA}, T_A = 25^\circ\text{C}$		50			mV
		$I_L = 0 \text{ mA}, -40^\circ\text{C} \leq T_A \leq +125^\circ\text{C}$		100			
		$I_L = 10 \text{ mA}, -40^\circ\text{C} \leq T_A \leq +125^\circ\text{C}$		500			
V_{EN}	ENABLE pin voltage	Voltage reference in active mode (EN = 1)		1.6			V
		Voltage reference in shutdown mode (EN = 0)		0.5			
I_{EN}	ENABLE pin leakage current	$V_{EN} = V_{IN} = 12 \text{ V}, -40^\circ\text{C} \leq T_A \leq 125^\circ\text{C}$			1	2	μA

7.6 Typical Characteristics

at $T_A = 25^\circ\text{C}$, $V_{IN} = V_{EN} = 12\text{ V}$, $I_L = 0\text{ mA}$, $C_L = 10\ \mu\text{F}$, $C_{IN} = 0.1\ \mu\text{F}$ (unless otherwise noted)

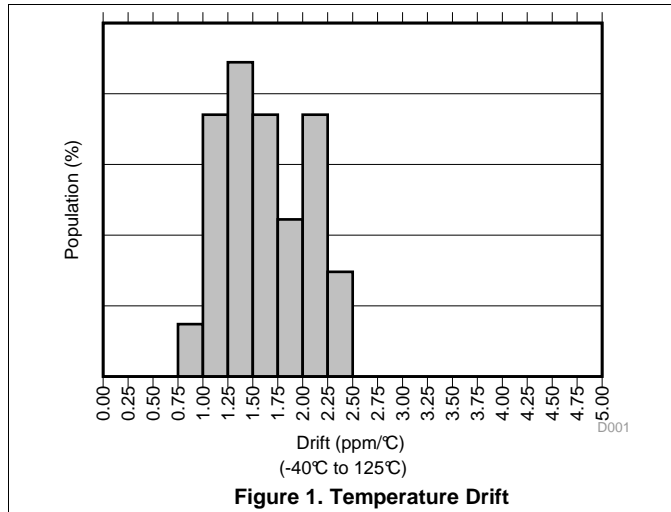

Figure 1. Temperature Drift

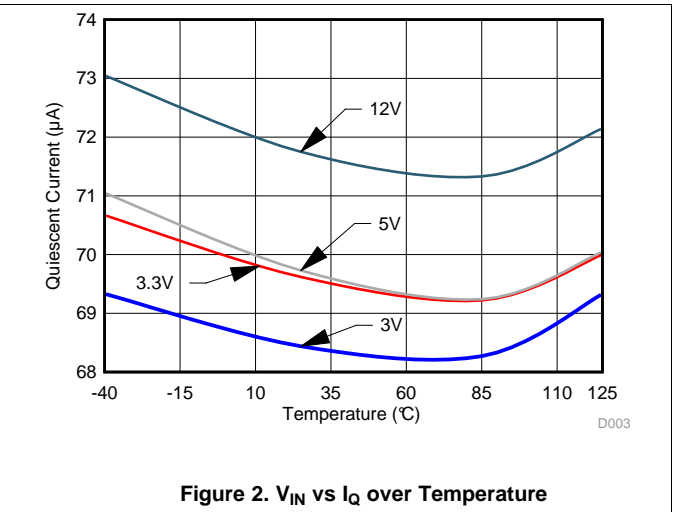

Figure 2. V_{IN} vs I_Q over Temperature

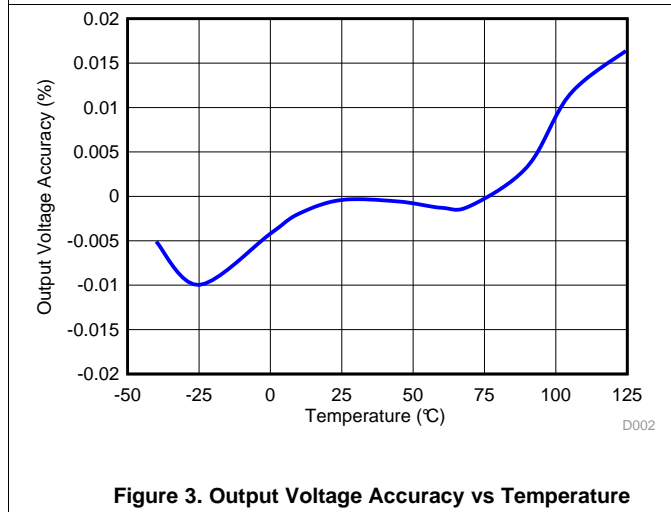

Figure 3. Output Voltage Accuracy vs Temperature

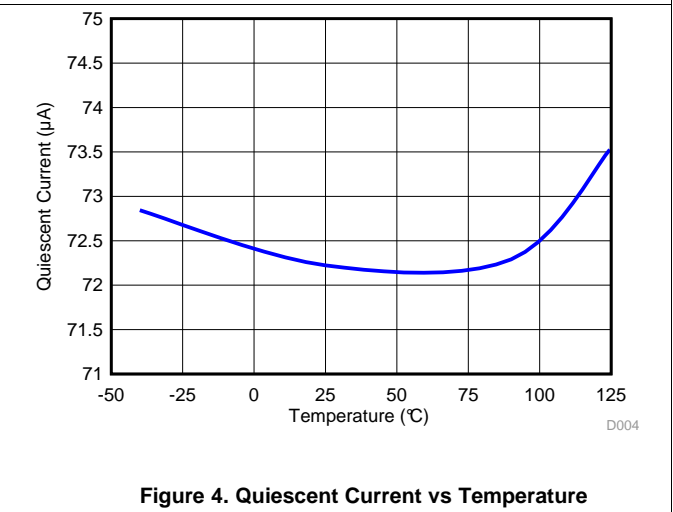

Figure 4. Quiescent Current vs Temperature

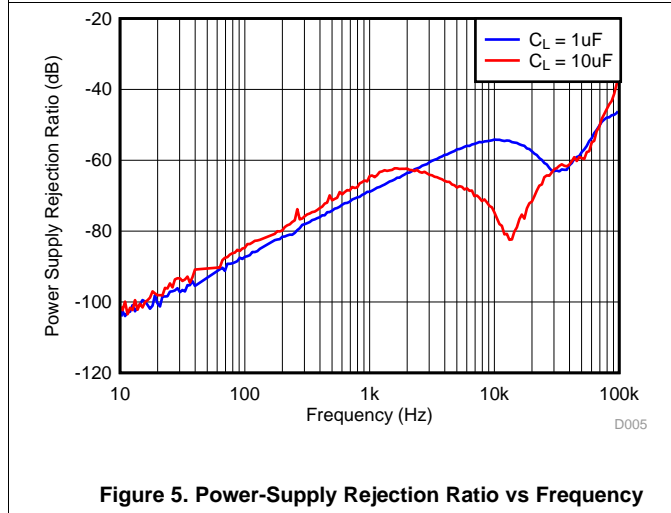

Figure 5. Power-Supply Rejection Ratio vs Frequency

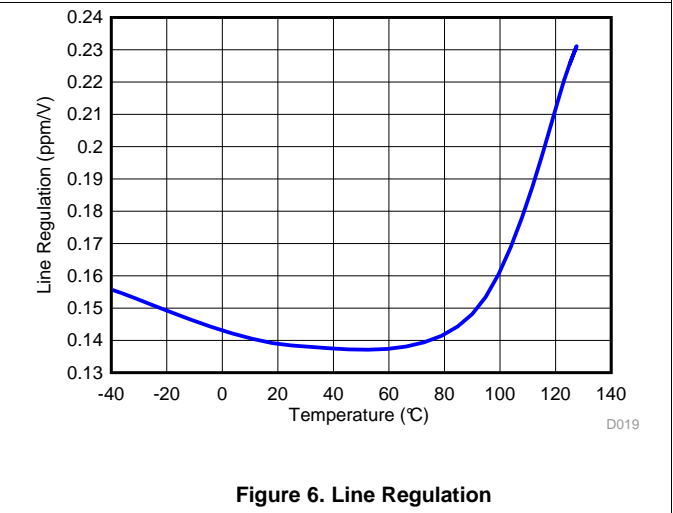

Figure 6. Line Regulation

Typical Characteristics (continued)

at $T_A = 25^\circ\text{C}$, $V_{IN} = V_{EN} = 12\text{ V}$, $I_L = 0\text{ mA}$, $C_L = 10\ \mu\text{F}$, $C_{IN} = 0.1\ \mu\text{F}$ (unless otherwise noted)

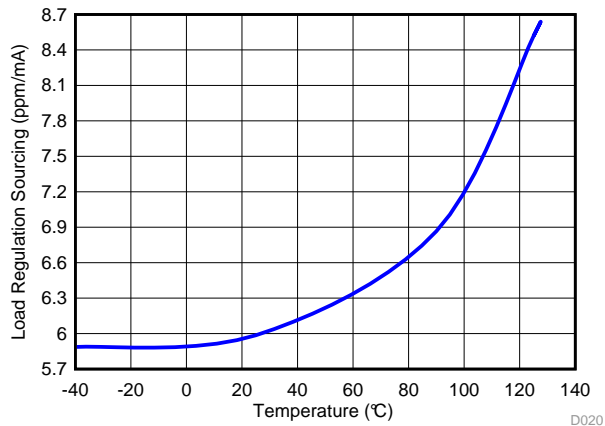

Figure 7. Load Regulation Sourcing

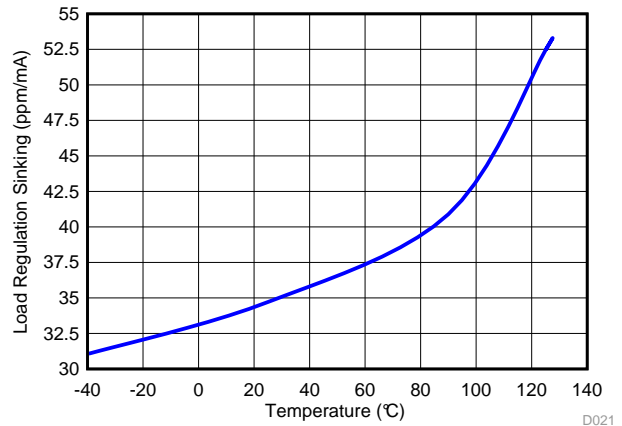

Figure 8. Load Regulation Sinking

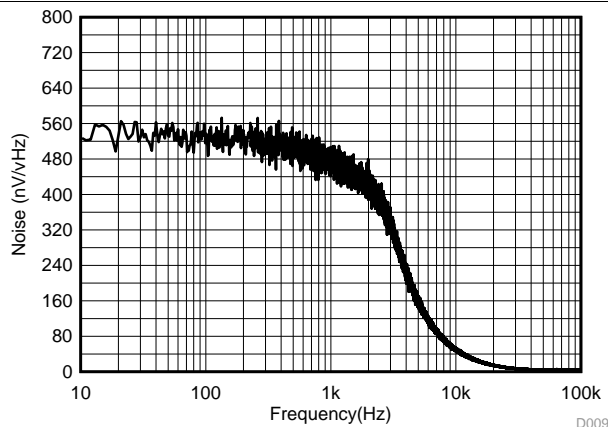

Figure 9. Noise Performance 10 Hz to 10 kHz

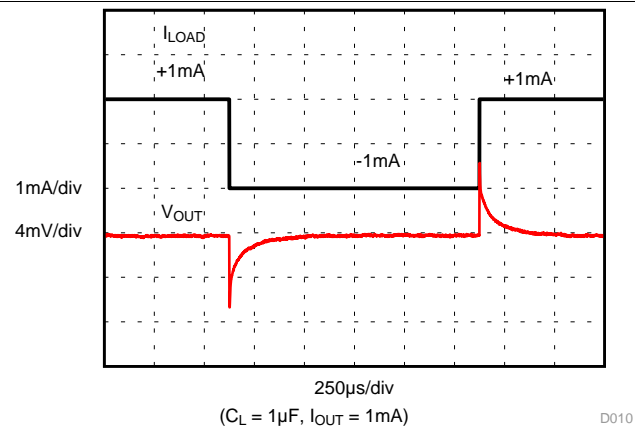

Figure 10. Load Transient

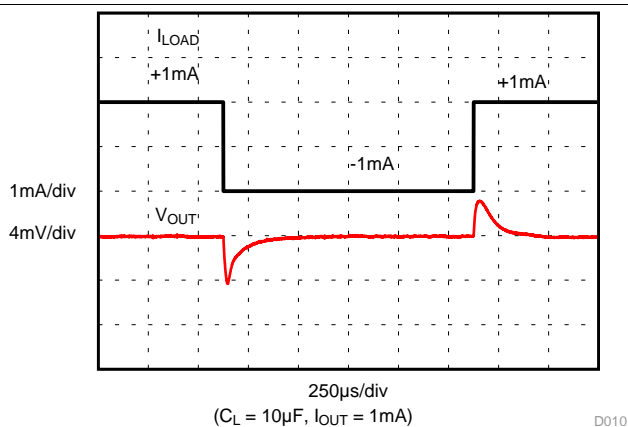

Figure 11. Load Transient

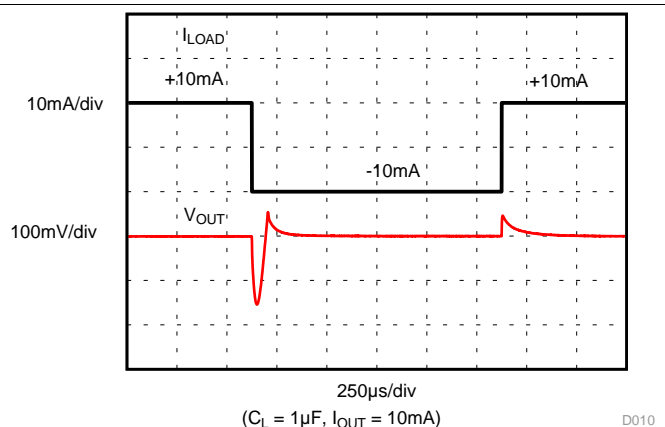

Figure 12. Load Transient

Typical Characteristics (continued)

at $T_A = 25^\circ\text{C}$, $V_{IN} = V_{EN} = 12\text{ V}$, $I_L = 0\text{ mA}$, $C_L = 10\ \mu\text{F}$, $C_{IN} = 0.1\ \mu\text{F}$ (unless otherwise noted)

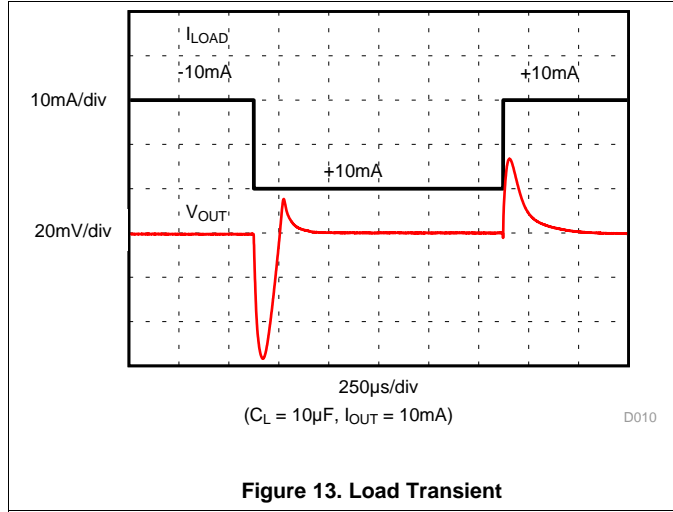

Figure 13. Load Transient

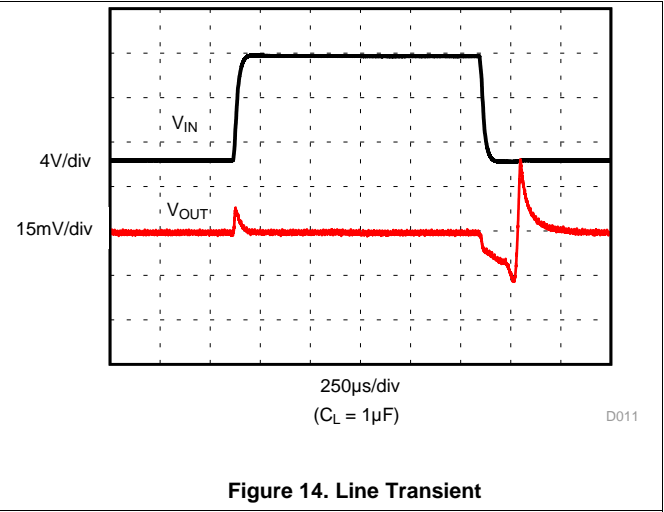

Figure 14. Line Transient

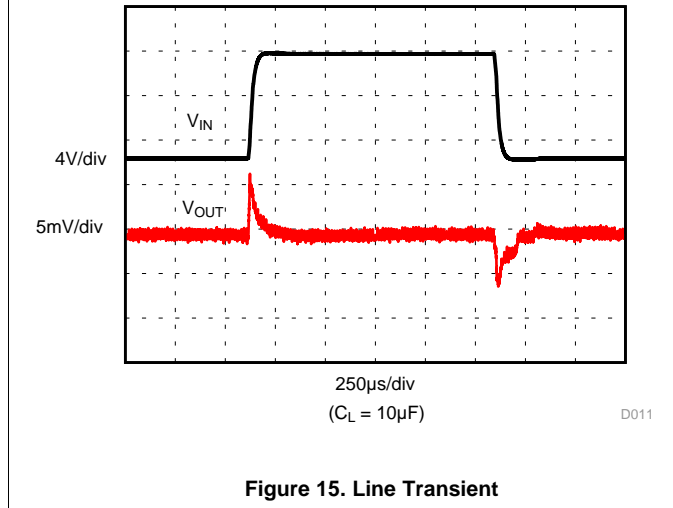

Figure 15. Line Transient

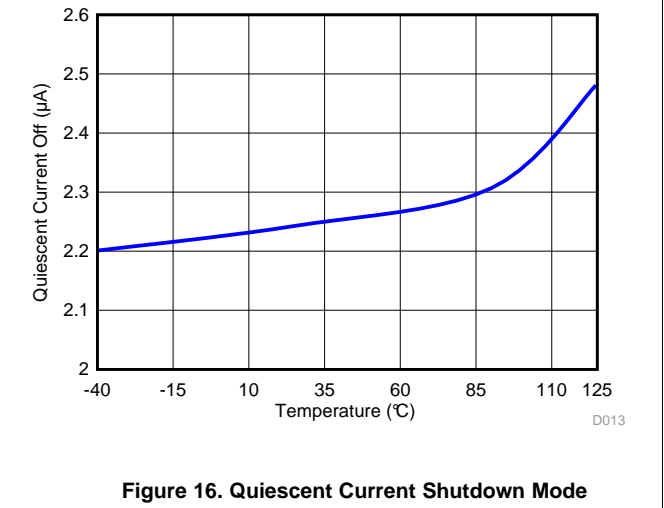

Figure 16. Quiescent Current Shutdown Mode

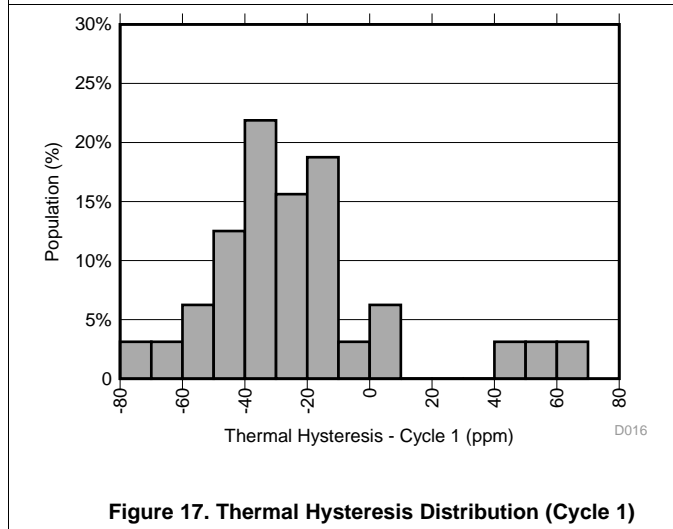

Figure 17. Thermal Hysteresis Distribution (Cycle 1)

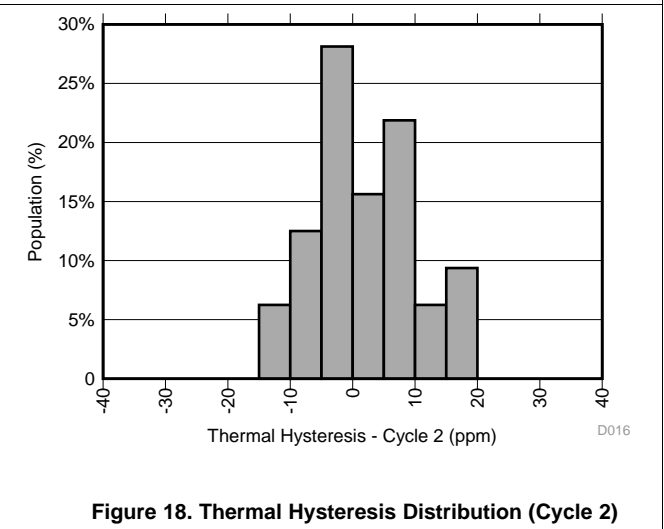

Figure 18. Thermal Hysteresis Distribution (Cycle 2)

Typical Characteristics (continued)

at $T_A = 25^\circ\text{C}$, $V_{IN} = V_{EN} = 12\text{ V}$, $I_L = 0\text{ mA}$, $C_L = 10\text{ }\mu\text{F}$, $C_{IN} = 0.1\text{ }\mu\text{F}$ (unless otherwise noted)



Figure 19. Solder Heat Shift Distribution

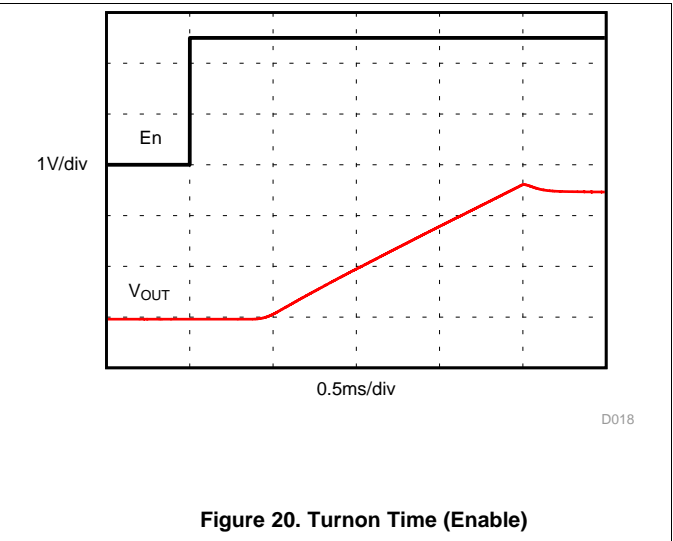

Figure 20. Turnon Time (Enable)

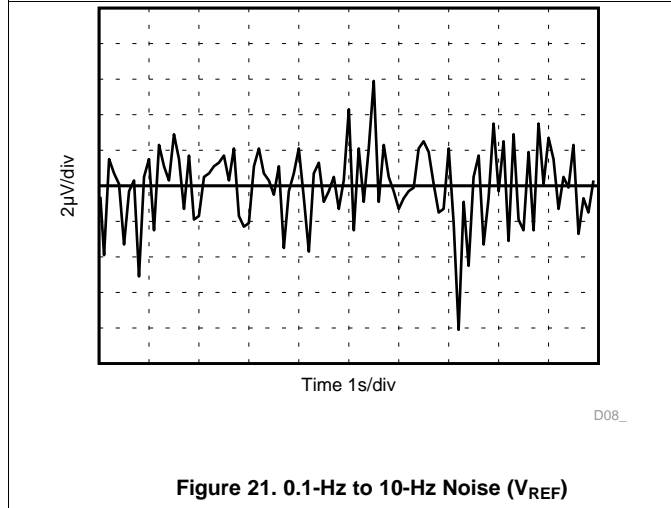

Figure 21. 0.1-Hz to 10-Hz Noise (V_{REF})

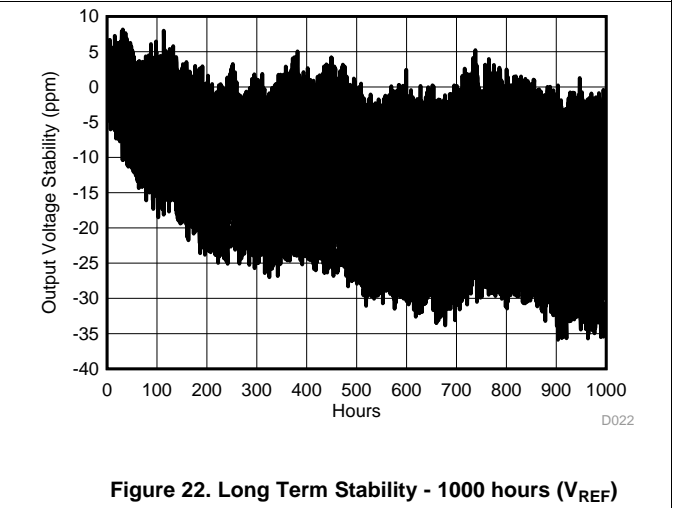

Figure 22. Long Term Stability - 1000 hours (V_{REF})

8 Parameter Measurement Information

8.1 Solder Heat Shift

The materials used in the manufacture of the REF34xx have differing coefficients of thermal expansion, resulting in stress on the device die when the part is heated. Mechanical and thermal stress on the device die can cause the output voltages to shift, degrading the initial accuracy specifications of the product. Reflow soldering is a common cause of this error.

In order to illustrate this effect, a total of 32 devices were soldered on four printed circuit boards [16 devices on each printed circuit board (PCB)] using lead-free solder paste and the paste manufacturer suggested reflow profile. The reflow profile is as shown in Figure 23. The printed circuit board is comprised of FR4 material. The board thickness is 1.65 mm and the area is 114 mm × 152 mm.

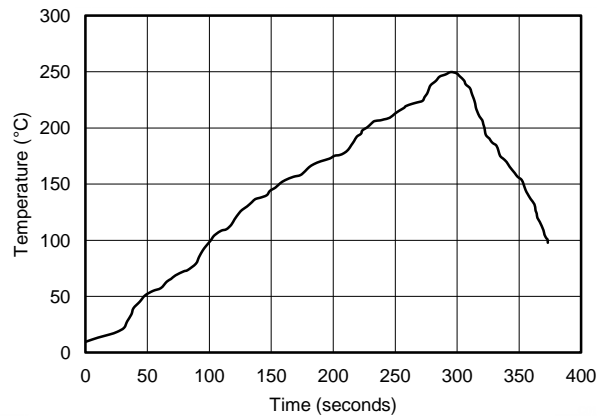

Figure 23. Reflow Profile

The reference output voltage is measured before and after the reflow process; the typical shift is displayed in Figure 24. Although all tested units exhibit very low shifts (< 0.01%), higher shifts are also possible depending on the size, thickness, and material of the printed circuit board. An important note is that the histograms display the typical shift for exposure to a single reflow profile. Exposure to multiple reflows, as is common on PCBs with surface-mount components on both sides, causes additional shifts in the output bias voltage. If the PCB is exposed to multiple reflows, the device must be soldered in the second pass to minimize its exposure to thermal stress.

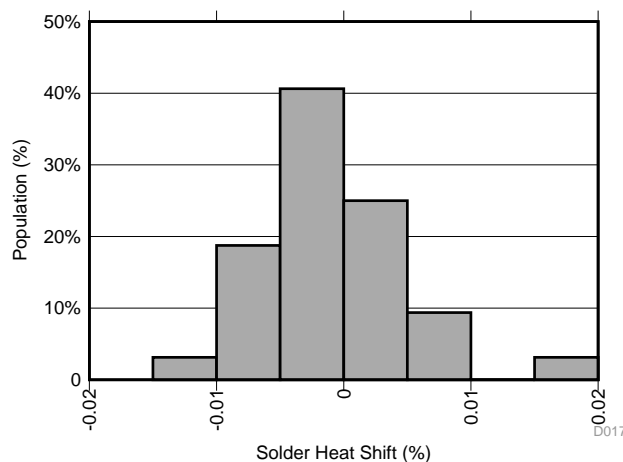

Figure 24. Solder Heat Shift Distribution, V_{REF} (%)

8.2 Long-Term Stability

One of the key parameters of the REF34xx references is long-term stability. Typical characteristic expressed as: curves shows the typical drift value for the REF34xx is 25 ppm from 0 to 1000 hours. This parameter is characterized by measuring 32 units at regular intervals for a period of 1000 hours. It is important to understand that long-term stability is not ensured by design and that the output from the device may shift beyond the typical 25 ppm specification at any time. For systems that require highly stable output voltages over long periods of time, the designer should consider burning in the devices prior to use to minimize the amount of output drift exhibited by the reference over time.

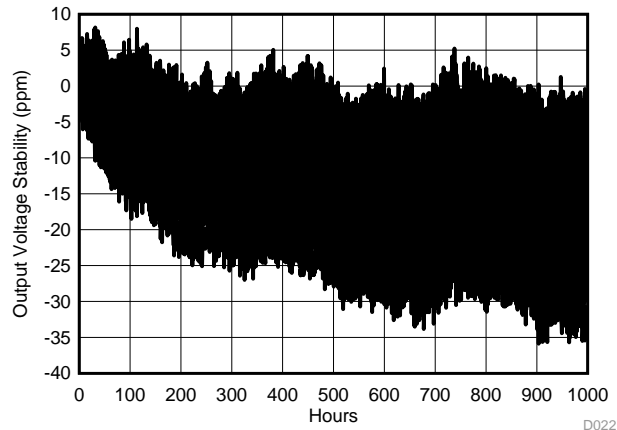

Figure 25. Long Term Stability - 1000 hours (V_{REF})

8.3 Thermal Hysteresis

Thermal hysteresis is measured with the REF34xx soldered to a PCB, similar to a real-world application. Thermal hysteresis for the device is defined as the change in output voltage after operating the device at 25°C, cycling the device through the specified temperature range, and returning to 25°C. The PCB was baked at 150°C for 30 minutes before thermal hysteresis was measured. Hysteresis can be expressed by [Equation 1](#):

$$V_{HYST} = \left(\frac{|V_{PRE} - V_{POST}|}{V_{NOM}} \right) \times 10^6 \text{ (ppm)}$$

where

- V_{HYST} = thermal hysteresis (in units of ppm)
- V_{NOM} = the specified output voltage
- V_{PRE} = output voltage measured at 25°C pre-temperature cycling
- V_{POST} = output voltage measured after the device has cycled from 25°C through the specified temperature range of –40°C to +125°C and returns to 25°C. (1)

Typical thermal hysteresis distribution is as shown in [Figure 26](#).

Thermal Hysteresis (continued)

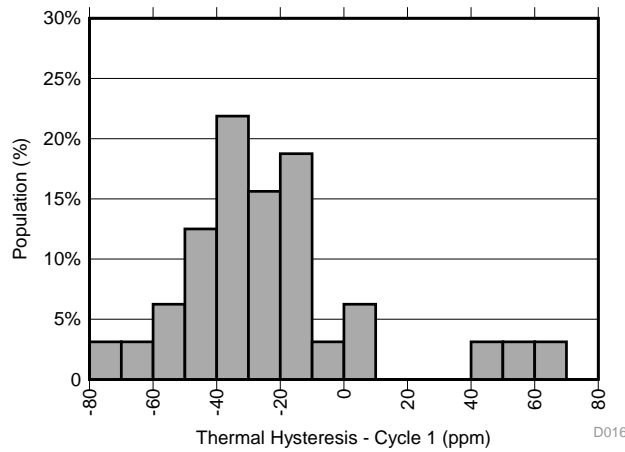

Figure 26. Thermal Hysteresis Distribution (V_{REF})

8.4 Power Dissipation

The REF34xx voltage references are capable of source and sink up to 10 mA of load current across the rated input voltage range. However, when used in applications subject to high ambient temperatures, the input voltage and load current must be carefully monitored to ensure that the device does not exceeded its maximum power dissipation rating. The maximum power dissipation of the device can be calculated with [Equation 2](#):

$$T_J = T_A + P_D \times R_{\theta JA}$$

where

- P_D is the device power dissipation
- T_J is the device junction temperature
- T_A is the ambient temperature
- R_{θJA} is the package (junction-to-air) thermal resistance (2)

Because of this relationship, acceptable load current in high temperature conditions may be less than the maximum current-sourcing capability of the device. In no case should the device be operated outside of its maximum power rating because doing so can result in premature failure or permanent damage to the device.

8.5 Noise Performance

Typical 0.1-Hz to 10-Hz voltage noise can be seen in [Figure 27](#). Device noise increases with output voltage and operating temperature. Additional filtering can be used to improve output noise levels, although care must be taken to ensure the output impedance does not degrade ac performance. Peak-to-peak noise measurement setup is shown in [Figure 27](#).

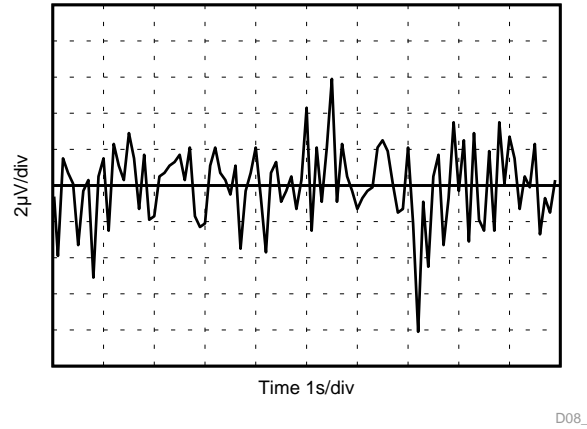

Figure 27. 0.1-Hz to 10-Hz Noise (V_{REF})

9 Detailed Description

9.1 Overview

The REF34xx is family of low-noise, precision bandgap voltage references that are specifically designed for excellent initial voltage accuracy and drift. The [Functional Block Diagram](#) is a simplified block diagram of the REF34xx showing basic band-gap topology.

9.2 Functional Block Diagram

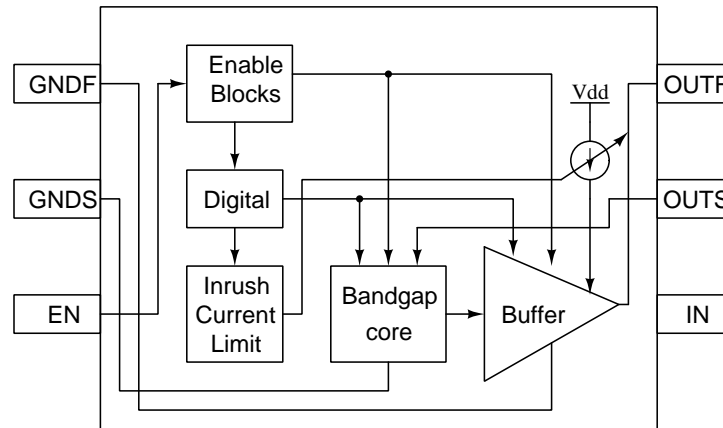

9.3 Feature Description

9.3.1 Supply Voltage

The REF34xx family of references features an extremely low dropout voltage. For loaded conditions, a typical dropout voltage versus load is shown on the front page. The REF34xx features a low quiescent current that is extremely stable over changes in both temperature and supply. The typical room temperature quiescent current is 72 μA , and the maximum quiescent current over temperature is just 95 μA . Supply voltages below the specified levels can cause the REF34xx to momentarily draw currents greater than the typical quiescent current. Use a power supply with a fast rising edge and low output impedance to easily prevent this issue.

9.3.2 Low Temperature Drift

The REF34xx is designed for minimal drift error, which is defined as the change in output voltage over temperature. The drift is calculated using the box method, as described by [Equation 3](#):

$$\text{Drift} = \left(\frac{V_{\text{REF(MAX)}} - V_{\text{REF(MIN)}}}{V_{\text{REF}} \times \text{Temperature Range}} \right) \times 10^6 \quad (3)$$

9.3.3 Load Current

The REF34xx family is specified to deliver a current load of ± 10 mA per output. The V_{REF} output of the device are protected from short circuits by limiting the output short-circuit current to 18 mA. The device temperature increases according to [Equation 4](#):

$$T_J = T_A + P_D \times R_{\theta JA}$$

where

- T_J = junction temperature ($^{\circ}\text{C}$),
 - T_A = ambient temperature ($^{\circ}\text{C}$),
 - P_D = power dissipated (W), and
 - $R_{\theta JA}$ = junction-to-ambient thermal resistance ($^{\circ}\text{C}/\text{W}$)
- (4)

The REF34xx maximum junction temperature must not exceed the absolute maximum rating of 150 $^{\circ}\text{C}$.

9.4 Device Functional Modes

9.4.1 EN Pin

When the EN pin of the REF34xx is pulled high, the device is in active mode. The device must be in active mode for normal operation. The REF34xx can be placed in a low-power mode by pulling the ENABLE pin low. When in shutdown mode, the output of the device becomes high impedance and the quiescent current of the device reduces to 2 μA in shutdown mode. The EN pin must not be pulled higher than V_{IN} supply voltage. See the [Thermal Information](#) for logic high and logic low voltage levels.

9.4.2 Negative Reference Voltage

For applications requiring a negative and positive reference voltage, the REF34xx and OPA735 can be used to provide a dual-supply reference from a 5-V supply. [Figure 28](#) shows the REF34xx used to provide a 2.5-V supply reference voltage. The low drift performance of the REF34xx complements the low offset voltage and zero drift of the OPA735 to provide an accurate solution for split-supply applications. Take care to match the temperature coefficients of R1 and R2.

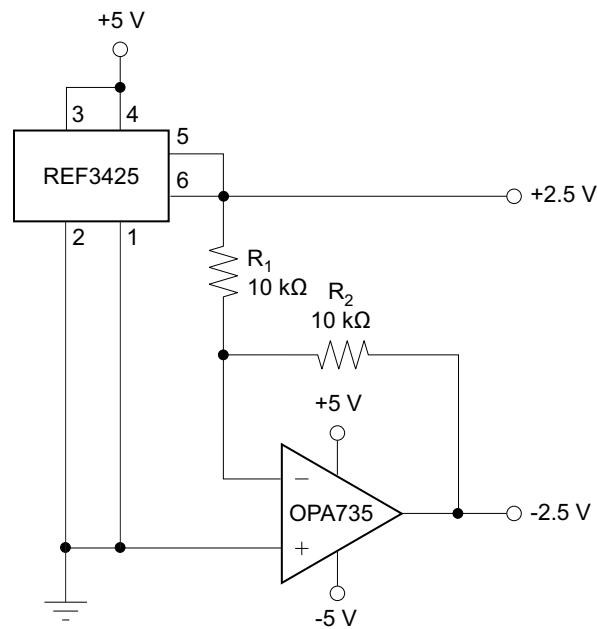

Copyright © 2017, Texas Instruments Incorporated

Figure 28. REF34xx and OPA735 Create Positive and Negative Reference Voltages

10 Application and Implementation

NOTE

Information in the following applications sections is not part of the TI component specification, and TI does not warrant its accuracy or completeness. TI's customers are responsible for determining suitability of components for their purposes. Customers should validate and test their design implementation to confirm system functionality.

10.1 Application Information

As this device has many applications and setups, there are many situations that this datasheet can not characterize in detail. Basic applications includes positive/negative voltage reference and data acquisition systems. The table below shows the typical application of REF34xx and its companion ADC/DAC.

Table 1. Typical Applications and Companion ADC/DAC

Applications	ADC/DAC
PLC - DCS	DAC8881, ADS8332, ADS8568, ADS8317, ADS8588S, ADS1287
Display Test Equipment	ADS8332
Field Transmitters - Pressure	ADUCM360
Video Surveillance - Thermal Cameras	ADS7279
Medical Blood Glucose Meter	ADS1112

10.2 Typical Application: Basic Voltage Reference Connection

The circuit shown in [Figure 29](#) shows the basic configuration for the REF34xx references. Connect bypass capacitors according to the guidelines in [Input and Output Capacitors](#).

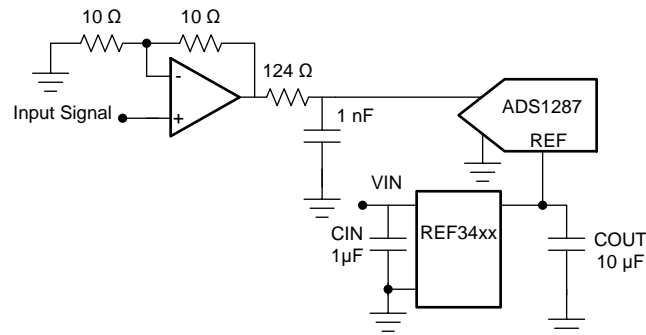

Copyright © 2017, Texas Instruments Incorporated

Figure 29. Basic Reference Connection

10.2.1 Design Requirements

A detailed design procedure is described based on a design example. For this design example, use the parameters listed in [Table 2](#) as the input parameters.

Table 2. Design Example Parameters

DESIGN PARAMETER	VALUE
Input voltage V_{IN}	5 V
Output voltage V_{OUT}	2.5 V
REF34xx input capacitor	1 μ F
REF34xx output capacitor	10 μ F

10.2.2 Detailed Design Procedure

10.2.2.1 Input and Output Capacitors

A 1- μ F to 10- μ F electrolytic or ceramic capacitor can be connected to the input to improve transient response in applications where the supply voltage may fluctuate. Connect an additional 0.1- μ F ceramic capacitor in parallel to reduce high frequency supply noise.

A ceramic capacitor of at least a 0.1 μ F must be connected to the output to improve stability and help filter out high frequency noise. An additional 1- μ F to 10- μ F electrolytic or ceramic capacitor can be added in parallel to improve transient performance in response to sudden changes in load current; however, keep in mind that doing so increases the turnon time of the device.

Best performance and stability is attained with low-ESR, low-inductance ceramic chip-type output capacitors (X5R, X7R, or similar). If using an electrolytic capacitor on the output, place a 0.1- μ F ceramic capacitor in parallel to reduce overall ESR on the output.

10.2.2.2 4-Wire Kelvin Connections

Current flowing through a PCB trace produces an IR voltage drop, and with longer traces, this drop can reach several millivolts or more, introducing a considerable error into the output voltage of the reference. A 1-inch long, 5-millimeter wide trace of 1-ounce copper has a resistance of approximately 100 m Ω at room temperature; at a load current of 10 mA, this can introduce a full millivolt of error. In an ideal board layout, the reference must be mounted as close as possible to the load to minimize the length of the output traces, and, therefore, the error introduced by voltage drop. However, in applications where this is not possible or convenient, force and sense connections (sometimes referred to as Kelvin sensing connections) are provided as a means of minimizing the IR drop and improving accuracy.

Kelvin connections work by providing a set of high impedance voltage-sensing lines to the output and ground nodes. Because very little current flows through these connections, the IR drop across their traces is negligible, and the output and ground voltage information can be obtain with minimum IR drop error.

It is always advantageous to use Kelvin connections whenever possible. However, in applications where the IR drop is negligible or an extra set of traces cannot be routed to the load, the force and sense pins for both V_{OUT} and GND can simply be tied together, and the device can be used in the same fashion as a normal 3-terminal reference (as shown in [Figure 28](#)).

10.2.2.3 V_{IN} Slew Rate Considerations

In applications with slow-rising input voltage signals, the reference exhibits overshoot or other transient anomalies that appear on the output. These phenomena also appear during shutdown as the internal circuitry loses power.

To avoid such conditions, ensure that the input voltage wave-form has both a rising and falling slew rate close to 6 V/ms.

10.2.2.4 Shutdown/Enable Feature

The REF34xx references can be switched to a low power shut-down mode when a voltage of 0.5 V or lower is input to the ENABLE pin. Likewise, the reference becomes operational for ENABLE voltages of 1.6 V or higher. During shutdown, the supply current drops to less than 2 μ A, useful in applications that are sensitive to power consumption.

If using the shutdown feature, ensure that the ENABLE pin voltage does not fall between 0.5 V and 1.6 V because this causes a large increase in the supply current of the device and may keep the reference from starting up correctly. If not using the shutdown feature, however, the ENABLE pin can simply be tied to the IN pin, and the reference remains operational continuously.

10.2.3 Application Curves

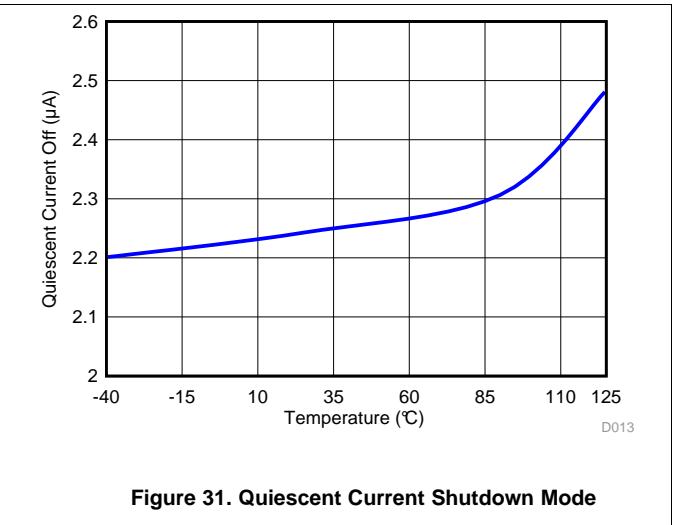
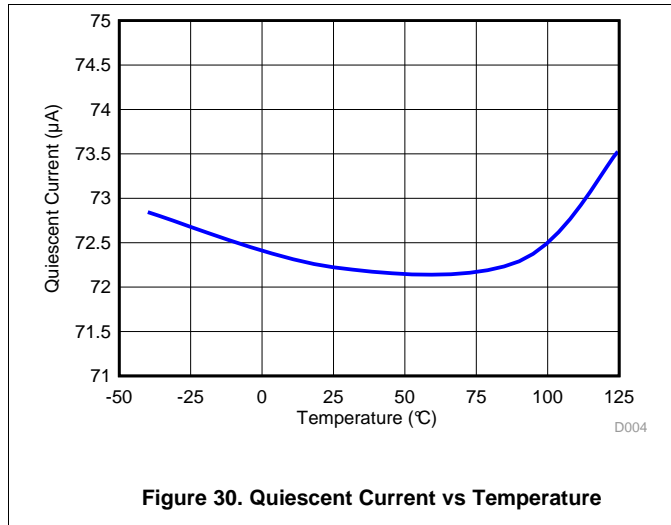

11 Power Supply Recommendations

The REF34xx family of references feature an extremely low-dropout voltage. These references can be operated with a supply of only 50 mV above the output voltage. TI recommends a supply bypass capacitor ranging between 0.1 µF to 10 µF.

12 Layout

12.1 Layout Guidelines

Figure 32 illustrates an example of a PCB layout for a data acquisition system using the REF34xx. Some key considerations are:

- Connect low-ESR, 0.1- μ F ceramic bypass capacitors at V_{IN} , V_{REF} of the REF34xx.
- Decouple other active devices in the system per the device specifications.
- Using a solid ground plane helps distribute heat and reduces electromagnetic interference (EMI) noise pickup.
- Place the external components as close to the device as possible. This configuration prevents parasitic errors (such as the Seebeck effect) from occurring.
- Do not run sensitive analog traces in parallel with digital traces. Avoid crossing digital and analog traces if possible, and only make perpendicular crossings when absolutely necessary.

12.2 Layout Example

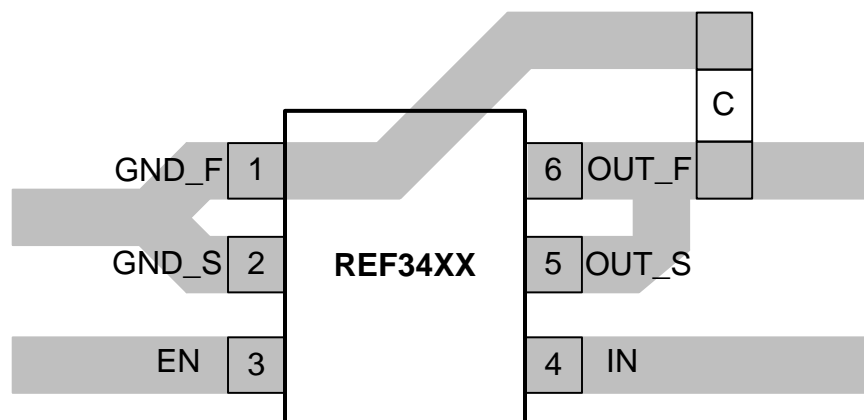

Figure 32. Layout Example

13 Device and Documentation Support

13.1 Documentation Support

13.1.1 Related Documentation

For related documentation see the following:

- [INA21x Voltage Output, Low- or High-Side Measurement, Bidirectional, Zero-Drift Series, Current-Shunt Monitors](#)
- [Low-Drift Bidirectional Single-Supply Low-Side Current Sensing Reference Design](#)

13.2 Receiving Notification of Documentation Updates

To receive notification of documentation updates, navigate to the device product folder on ti.com. In the upper right corner, click on *Alert me* to register and receive a weekly digest of any product information that has changed. For change details, review the revision history included in any revised document.

13.3 Community Resources

The following links connect to TI community resources. Linked contents are provided "AS IS" by the respective contributors. They do not constitute TI specifications and do not necessarily reflect TI's views; see TI's [Terms of Use](#).

TI E2E™ Online Community *TI's Engineer-to-Engineer (E2E) Community*. Created to foster collaboration among engineers. At e2e.ti.com, you can ask questions, share knowledge, explore ideas and help solve problems with fellow engineers.

Design Support *TI's Design Support* Quickly find helpful E2E forums along with design support tools and contact information for technical support.

13.4 Trademarks

E2E is a trademark of Texas Instruments.
All other trademarks are the property of their respective owners.

13.5 Electrostatic Discharge Caution



This integrated circuit can be damaged by ESD. Texas Instruments recommends that all integrated circuits be handled with appropriate precautions. Failure to observe proper handling and installation procedures can cause damage.

ESD damage can range from subtle performance degradation to complete device failure. Precision integrated circuits may be more susceptible to damage because very small parametric changes could cause the device not to meet its published specifications.

13.6 Glossary

SLYZ022 — *TI Glossary*.

This glossary lists and explains terms, acronyms, and definitions.

14 Mechanical, Packaging, and Orderable Information

The following pages include mechanical packaging and orderable information. This information is the most current data available for the designated devices. This data is subject to change without notice and revision of this document. For browser-based versions of this data sheet, refer to the left-hand navigation.

PACKAGING INFORMATION

Orderable Device	Status (1)	Package Type	Package Drawing	Pins	Package Qty	Eco Plan (2)	Lead/Ball Finish (6)	MSL Peak Temp (3)	Op Temp (°C)	Device Marking (4/5)	Samples
REF3425IDBVR	ACTIVE	SOT-23	DBV	6	3000	Green (RoHS & no Sb/Br)	CU NIPDAU	Level-2-250C-1 YEAR	-40 to 125	19ED	Samples
REF3430IDBVR	ACTIVE	SOT-23	DBV	6	3000	Green (RoHS & no Sb/Br)	CU NIPDAU	Level-2-260C-1 YEAR	-40 to 125	1H6D	Samples
REF3433IDBVR	ACTIVE	SOT-23	DBV	6	3000	Green (RoHS & no Sb/Br)	CU NIPDAU	Level-2-260C-1 YEAR	-40 to 125	1H5D	Samples
REF3440IDBVR	ACTIVE	SOT-23	DBV	6	3000	Green (RoHS & no Sb/Br)	CU NIPDAU	Level-2-260C-1 YEAR	-40 to 125	1MJD	Samples
REF3450IDBVR	ACTIVE	SOT-23	DBV	6	3000	Green (RoHS & no Sb/Br)	CU NIPDAU	Level-2-260C-1 YEAR	-40 to 125	1MKD	Samples

(1) The marketing status values are defined as follows:

ACTIVE: Product device recommended for new designs.

LIFEBUY: TI has announced that the device will be discontinued, and a lifetime-buy period is in effect.

NRND: Not recommended for new designs. Device is in production to support existing customers, but TI does not recommend using this part in a new design.

PREVIEW: Device has been announced but is not in production. Samples may or may not be available.

OBSELETE: TI has discontinued the production of the device.

(2) **RoHS:** TI defines "RoHS" to mean semiconductor products that are compliant with the current EU RoHS requirements for all 10 RoHS substances, including the requirement that RoHS substance do not exceed 0.1% by weight in homogeneous materials. Where designed to be soldered at high temperatures, "RoHS" products are suitable for use in specified lead-free processes. TI may reference these types of products as "Pb-Free".

RoHS Exempt: TI defines "RoHS Exempt" to mean products that contain lead but are compliant with EU RoHS pursuant to a specific EU RoHS exemption.

Green: TI defines "Green" to mean the content of Chlorine (Cl) and Bromine (Br) based flame retardants meet JS709B low halogen requirements of <=1000ppm threshold. Antimony trioxide based flame retardants must also meet the <=1000ppm threshold requirement.

(3) MSL, Peak Temp. - The Moisture Sensitivity Level rating according to the JEDEC industry standard classifications, and peak solder temperature.

(4) There may be additional marking, which relates to the logo, the lot trace code information, or the environmental category on the device.

(5) Multiple Device Markings will be inside parentheses. Only one Device Marking contained in parentheses and separated by a "-" will appear on a device. If a line is indented then it is a continuation of the previous line and the two combined represent the entire Device Marking for that device.

(6) Lead/Ball Finish - Orderable Devices may have multiple material finish options. Finish options are separated by a vertical ruled line. Lead/Ball Finish values may wrap to two lines if the finish value exceeds the maximum column width.

Important Information and Disclaimer: The information provided on this page represents TI's knowledge and belief as of the date that it is provided. TI bases its knowledge and belief on information provided by third parties, and makes no representation or warranty as to the accuracy of such information. Efforts are underway to better integrate information from third parties. TI has taken and continues to take reasonable steps to provide representative and accurate information but may not have conducted destructive testing or chemical analysis on incoming materials and chemicals. TI and TI suppliers consider certain information to be proprietary, and thus CAS numbers and other limited information may not be available for release.

In no event shall TI's liability arising out of such information exceed the total purchase price of the TI part(s) at issue in this document sold by TI to Customer on an annual basis.

TAPE AND REEL INFORMATION

QUADRANT ASSIGNMENTS FOR PIN 1 ORIENTATION IN TAPE

*All dimensions are nominal

Device	Package Type	Package Drawing	Pins	SPQ	Reel Diameter (mm)	Reel Width W1 (mm)	A0 (mm)	B0 (mm)	K0 (mm)	P1 (mm)	W (mm)	Pin1 Quadrant
REF3425IDBVR	SOT-23	DBV	6	3000	178.0	9.0	3.23	3.17	1.37	4.0	8.0	Q3
REF3430IDBVR	SOT-23	DBV	6	3000	178.0	9.0	3.23	3.17	1.37	4.0	8.0	Q3
REF3433IDBVR	SOT-23	DBV	6	3000	178.0	9.0	3.23	3.17	1.37	4.0	8.0	Q3
REF3440IDBVR	SOT-23	DBV	6	3000	178.0	9.0	3.23	3.17	1.37	4.0	8.0	Q3
REF3450IDBVR	SOT-23	DBV	6	3000	178.0	9.0	3.23	3.17	1.37	4.0	8.0	Q3

TAPE AND REEL BOX DIMENSIONS



*All dimensions are nominal

Device	Package Type	Package Drawing	Pins	SPQ	Length (mm)	Width (mm)	Height (mm)
REF3425IDBVR	SOT-23	DBV	6	3000	445.0	220.0	345.0
REF3430IDBVR	SOT-23	DBV	6	3000	445.0	220.0	345.0
REF3433IDBVR	SOT-23	DBV	6	3000	445.0	220.0	345.0
REF3440IDBVR	SOT-23	DBV	6	3000	445.0	220.0	345.0
REF3450IDBVR	SOT-23	DBV	6	3000	445.0	220.0	345.0

MECHANICAL DATA

DBV (R-PDSO-G6)

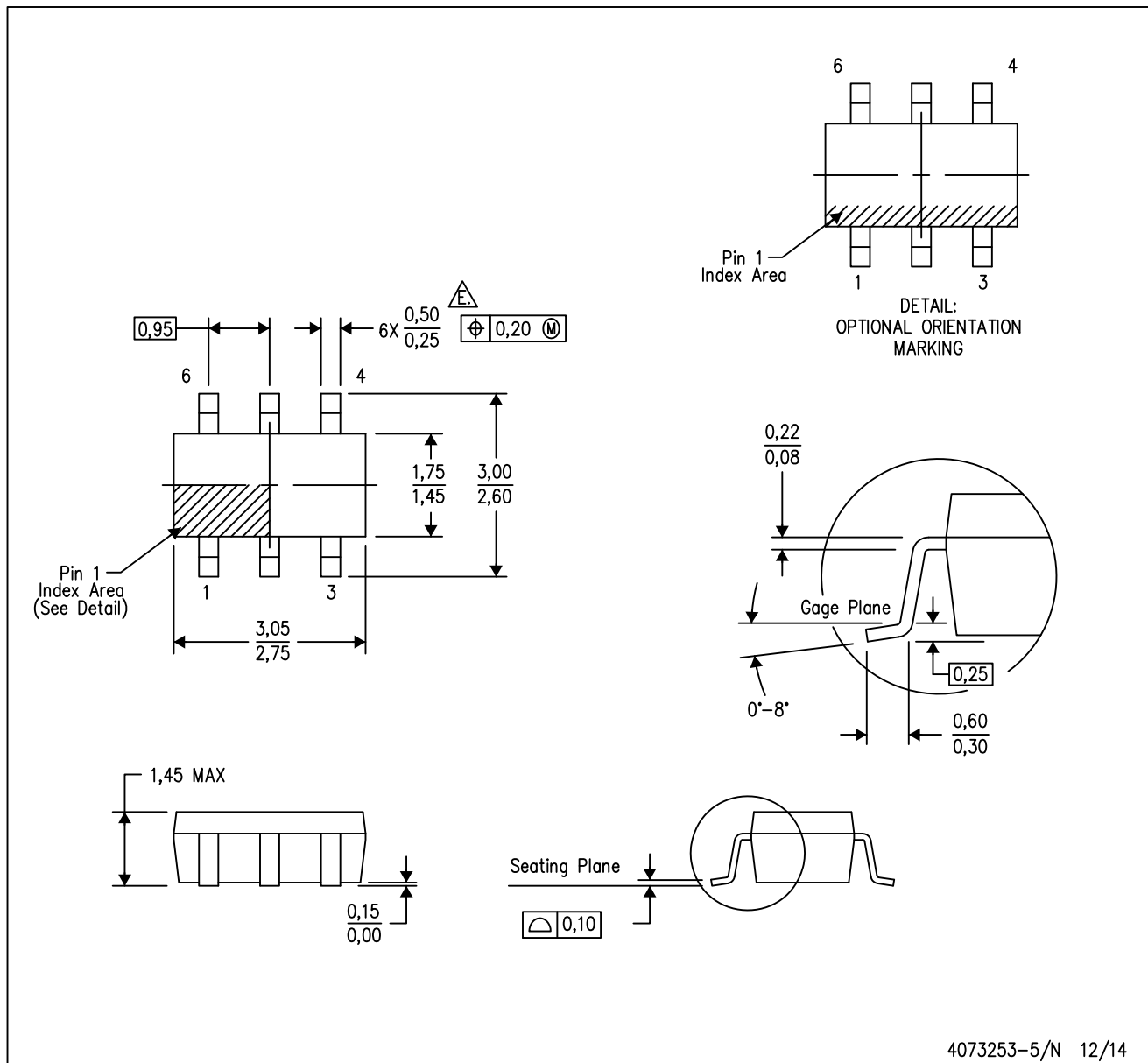
PLASTIC SMALL-OUTLINE PACKAGE



- NOTES:
- A. All linear dimensions are in millimeters.
 - B. This drawing is subject to change without notice.
 - C. Body dimensions do not include mold flash or protrusion. Mold flash and protrusion shall not exceed 0.15 per side.
 - D. Leads 1,2,3 may be wider than leads 4,5,6 for package orientation.
-  Falls within JEDEC MO-178 Variation AB, except minimum lead width.

DBV (R-PDSO-G6)

PLASTIC SMALL OUTLINE



- NOTES:
- A. All linear dimensions are in millimeters.
 - B. This drawing is subject to change without notice.
 - C. Customers should place a note on the circuit board fabrication drawing not to alter the center solder mask defined pad.
 - D. Publication IPC-7351 is recommended for alternate designs.
 - E. Laser cutting apertures with trapezoidal walls and also rounding corners will offer better paste release. Customers should contact their board assembly site for stencil design recommendations. Example stencil design based on a 50% volumetric metal load solder paste. Refer to IPC-7525 for other stencil recommendations.

IMPORTANT NOTICE

Texas Instruments Incorporated (TI) reserves the right to make corrections, enhancements, improvements and other changes to its semiconductor products and services per JESD46, latest issue, and to discontinue any product or service per JESD48, latest issue. Buyers should obtain the latest relevant information before placing orders and should verify that such information is current and complete.

TI's published terms of sale for semiconductor products (<http://www.ti.com/sc/docs/stdterms.htm>) apply to the sale of packaged integrated circuit products that TI has qualified and released to market. Additional terms may apply to the use or sale of other types of TI products and services.

Reproduction of significant portions of TI information in TI data sheets is permissible only if reproduction is without alteration and is accompanied by all associated warranties, conditions, limitations, and notices. TI is not responsible or liable for such reproduced documentation. Information of third parties may be subject to additional restrictions. Resale of TI products or services with statements different from or beyond the parameters stated by TI for that product or service voids all express and any implied warranties for the associated TI product or service and is an unfair and deceptive business practice. TI is not responsible or liable for any such statements.

Buyers and others who are developing systems that incorporate TI products (collectively, "Designers") understand and agree that Designers remain responsible for using their independent analysis, evaluation and judgment in designing their applications and that Designers have full and exclusive responsibility to assure the safety of Designers' applications and compliance of their applications (and of all TI products used in or for Designers' applications) with all applicable regulations, laws and other applicable requirements. Designer represents that, with respect to their applications, Designer has all the necessary expertise to create and implement safeguards that (1) anticipate dangerous consequences of failures, (2) monitor failures and their consequences, and (3) lessen the likelihood of failures that might cause harm and take appropriate actions. Designer agrees that prior to using or distributing any applications that include TI products, Designer will thoroughly test such applications and the functionality of such TI products as used in such applications.

TI's provision of technical, application or other design advice, quality characterization, reliability data or other services or information, including, but not limited to, reference designs and materials relating to evaluation modules, (collectively, "TI Resources") are intended to assist designers who are developing applications that incorporate TI products; by downloading, accessing or using TI Resources in any way, Designer (individually or, if Designer is acting on behalf of a company, Designer's company) agrees to use any particular TI Resource solely for this purpose and subject to the terms of this Notice.

TI's provision of TI Resources does not expand or otherwise alter TI's applicable published warranties or warranty disclaimers for TI products, and no additional obligations or liabilities arise from TI providing such TI Resources. TI reserves the right to make corrections, enhancements, improvements and other changes to its TI Resources. TI has not conducted any testing other than that specifically described in the published documentation for a particular TI Resource.

Designer is authorized to use, copy and modify any individual TI Resource only in connection with the development of applications that include the TI product(s) identified in such TI Resource. NO OTHER LICENSE, EXPRESS OR IMPLIED, BY ESTOPPEL OR OTHERWISE TO ANY OTHER TI INTELLECTUAL PROPERTY RIGHT, AND NO LICENSE TO ANY TECHNOLOGY OR INTELLECTUAL PROPERTY RIGHT OF TI OR ANY THIRD PARTY IS GRANTED HEREIN, including but not limited to any patent right, copyright, mask work right, or other intellectual property right relating to any combination, machine, or process in which TI products or services are used. Information regarding or referencing third-party products or services does not constitute a license to use such products or services, or a warranty or endorsement thereof. Use of TI Resources may require a license from a third party under the patents or other intellectual property of the third party, or a license from TI under the patents or other intellectual property of TI.

TI RESOURCES ARE PROVIDED "AS IS" AND WITH ALL FAULTS. TI DISCLAIMS ALL OTHER WARRANTIES OR REPRESENTATIONS, EXPRESS OR IMPLIED, REGARDING RESOURCES OR USE THEREOF, INCLUDING BUT NOT LIMITED TO ACCURACY OR COMPLETENESS, TITLE, ANY EPIDEMIC FAILURE WARRANTY AND ANY IMPLIED WARRANTIES OF MERCHANTABILITY, FITNESS FOR A PARTICULAR PURPOSE, AND NON-INFRINGEMENT OF ANY THIRD PARTY INTELLECTUAL PROPERTY RIGHTS. TI SHALL NOT BE LIABLE FOR AND SHALL NOT DEFEND OR INDEMNIFY DESIGNER AGAINST ANY CLAIM, INCLUDING BUT NOT LIMITED TO ANY INFRINGEMENT CLAIM THAT RELATES TO OR IS BASED ON ANY COMBINATION OF PRODUCTS EVEN IF DESCRIBED IN TI RESOURCES OR OTHERWISE. IN NO EVENT SHALL TI BE LIABLE FOR ANY ACTUAL, DIRECT, SPECIAL, COLLATERAL, INDIRECT, PUNITIVE, INCIDENTAL, CONSEQUENTIAL OR EXEMPLARY DAMAGES IN CONNECTION WITH OR ARISING OUT OF TI RESOURCES OR USE THEREOF, AND REGARDLESS OF WHETHER TI HAS BEEN ADVISED OF THE POSSIBILITY OF SUCH DAMAGES.

Unless TI has explicitly designated an individual product as meeting the requirements of a particular industry standard (e.g., ISO/TS 16949 and ISO 26262), TI is not responsible for any failure to meet such industry standard requirements.

Where TI specifically promotes products as facilitating functional safety or as compliant with industry functional safety standards, such products are intended to help enable customers to design and create their own applications that meet applicable functional safety standards and requirements. Using products in an application does not by itself establish any safety features in the application. Designers must ensure compliance with safety-related requirements and standards applicable to their applications. Designer may not use any TI products in life-critical medical equipment unless authorized officers of the parties have executed a special contract specifically governing such use. Life-critical medical equipment is medical equipment where failure of such equipment would cause serious bodily injury or death (e.g., life support, pacemakers, defibrillators, heart pumps, neurostimulators, and implantables). Such equipment includes, without limitation, all medical devices identified by the U.S. Food and Drug Administration as Class III devices and equivalent classifications outside the U.S.

TI may expressly designate certain products as completing a particular qualification (e.g., Q100, Military Grade, or Enhanced Product). Designers agree that it has the necessary expertise to select the product with the appropriate qualification designation for their applications and that proper product selection is at Designers' own risk. Designers are solely responsible for compliance with all legal and regulatory requirements in connection with such selection.

Designer will fully indemnify TI and its representatives against any damages, costs, losses, and/or liabilities arising out of Designer's non-compliance with the terms and provisions of this Notice.