

8A, 400V - 600V Ultrafast Diodes

The MUR840, MUR860, RURP840 and RURP860 are low forward voltage drop ultrafast recovery rectifiers ($t_{rr} < 60\text{ns}$). They use a glass-passivated ion-implanted, epitaxial construction.

These devices are intended for use as output rectifiers and flywheel diodes in a variety of high-frequency pulse-width modulated switching regulators. Their low stored charge and attendant fast reverse-recovery behavior minimize electrical noise generation and in many circuits markedly reduce the turn-on dissipation of the associated power switching transistors.

Formerly developmental type TA09616.

Ordering Information

| PART NUMBER | PACKAGE | BRAND |
|-------------|----------|---------|
| MUR840 | TO-220AC | MUR840 |
| RURP840 | TO-220AC | RURP840 |
| MUR860 | TO-220AC | MUR860 |
| RURP860 | TO-220AC | RURP860 |

NOTE: When ordering, use the entire part number.

Symbol



Features

- Ultrafast with Soft Recovery <60ns
- Operating Temperature 175°C
- Reverse Voltage 600V
- Avalanche Energy Rated
- Planar Construction

Applications

- Switching Power Supplies
- Power Switching Circuits
- General Purpose

Packaging

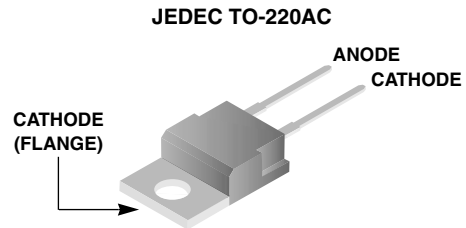

Absolute Maximum Ratings $T_C = 25^\circ\text{C}$, Unless Otherwise Specified

| | MUR840 RURP840 | MUR860 RURP860 | UNITS |
|--|-------------------|-------------------|-------|
| Peak Repetitive Reverse Voltage V_{RRM} | 400 | 600 | V |
| Working Peak Reverse Voltage V_{RWM} | 400 | 600 | V |
| DC Blocking Voltage V_R | 400 | 600 | V |
| Average Rectified Forward Current $I_{F(AV)}$ ($T_C = 155^\circ\text{C}$) | 8 | 8 | A |
| Repetitive Peak Surge Current I_{FRM} (Square Wave, 20kHz) | 16 | 16 | A |
| Nonrepetitive Peak Surge Current I_{FSM} (Halfwave, 1 Phase, 60Hz) | 100 | 100 | A |
| Maximum Power Dissipation P_D | 75 | 75 | W |
| Avalanche Energy (See Figures 10 and 11) E_{AVL} | 20 | 20 | mJ |
| Operating and Storage Temperature T_{STG}, T_J | -65 to 175 | -65 to 175 | °C |
| Maximum Lead Temperature for Soldering | | | |
| Leads at 0.063 in. (1.6mm) from case for 10s T_L | 300 | 300 | °C |
| Package Body for 10s, see Tech Brief 334. T_{PKG} | 260 | 260 | °C |

MUR840, MUR860, RURP840, RURP860

Electrical Specifications $T_C = 25^\circ\text{C}$, Unless Otherwise Specified

| SYMBOL | TEST CONDITION | MUR840, RURP840 | | | MUR860, RURP860 | | | UNITS |
|-----------------|--|-----------------|-----|-----|-----------------|-----|-----|---------------------------|
| | | MIN | TYP | MAX | MIN | TYP | MAX | |
| V_F | $I_F = 8\text{A}$ | - | - | 1.3 | - | - | 1.5 | V |
| | $I_F = 8\text{A}, T_C = 150^\circ\text{C}$ | - | - | 1.0 | - | - | 1.2 | V |
| I_R | $V_R = 400\text{V}$ | - | - | 100 | - | - | - | μA |
| | $V_R = 600\text{V}$ | - | - | - | - | - | 100 | μA |
| | $V_R = 400\text{V}, T_C = 150^\circ\text{C}$ | - | - | 500 | - | - | - | μA |
| | $V_R = 600\text{V}, T_C = 150^\circ\text{C}$ | - | - | - | - | - | 500 | μA |
| t_{rr} | $I_F = 1\text{A}, dI_F/dt = 200\text{A}/\mu\text{s}$ | - | - | 60 | - | - | 60 | ns |
| | $I_F = 8\text{A}, dI_F/dt = 200\text{A}/\mu\text{s}$ | - | - | 70 | - | - | 70 | ns |
| t_a | $I_F = 8\text{A}, dI_F/dt = 200\text{A}/\mu\text{s}$ | - | 32 | - | - | 32 | - | ns |
| t_b | $I_F = 8\text{A}, dI_F/dt = 200\text{A}/\mu\text{s}$ | - | 21 | - | - | 21 | - | ns |
| Q_{RR} | $I_F = 8\text{A}, dI_F/dt = 200\text{A}/\mu\text{s}$ | - | 195 | - | - | 195 | - | nC |
| C_J | $V_R = 10\text{V}, I_F = 0\text{A}$ | - | 25 | - | - | 25 | - | pF |
| $R_{\theta JC}$ | | - | - | 2 | - | - | 2 | $^\circ\text{C}/\text{W}$ |

DEFINITIONS

V_F = Instantaneous forward voltage ($p_w = 300\mu\text{s}$, $D = 2\%$).

I_R = Instantaneous reverse current.

t_{rr} = Reverse recovery time (See Figure 9), summation of $t_a + t_b$.

t_a = Time to reach peak reverse current (See Figure 9).

t_b = Time from peak I_{RM} to projected zero crossing of I_{RM} based on a straight line from peak I_{RM} through 25% of I_{RM} (See Figure 9).

Q_{RR} = Reverse recovery charge.

C_J = Junction Capacitance.

$R_{\theta JC}$ = Thermal resistance junction to case.

p_w = pulse width.

D = duty cycle.

Typical Performance Curves

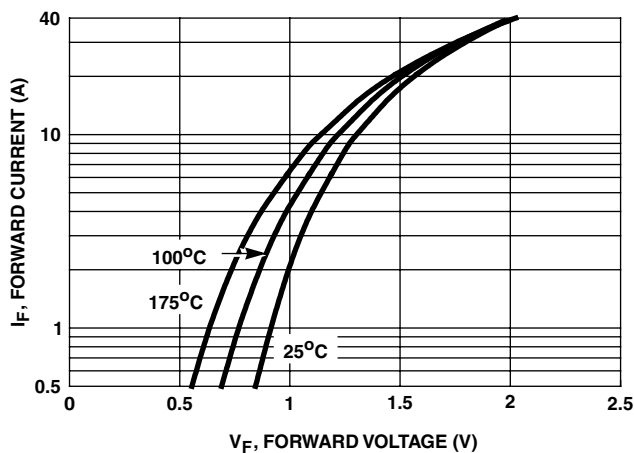

FIGURE 1. FORWARD CURRENT vs FORWARD VOLTAGE

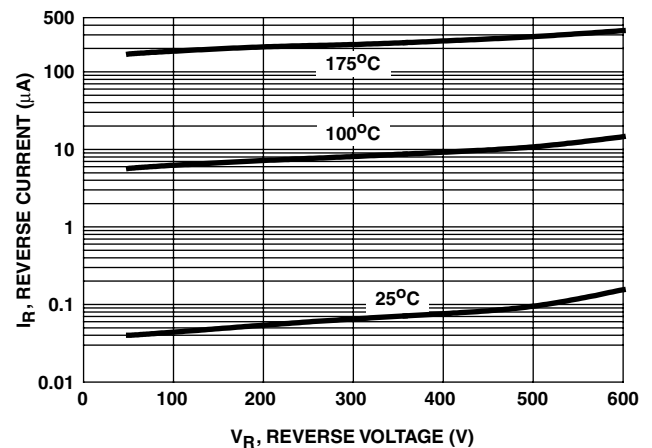

FIGURE 2. REVERSE CURRENT vs REVERSE VOLTAGE

Typical Performance Curves (Continued)

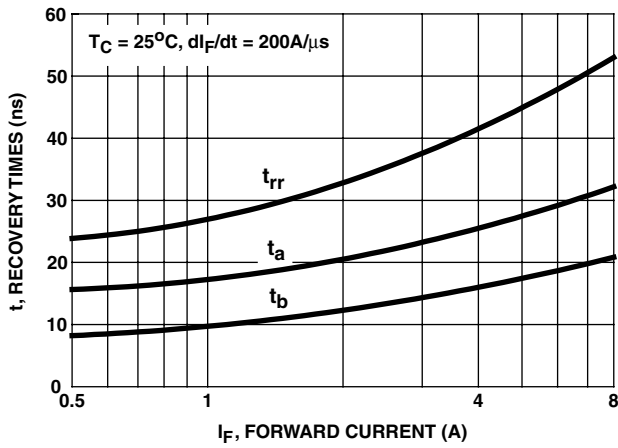

FIGURE 3. t_{rr} , t_a AND t_b CURVES vs FORWARD CURRENT

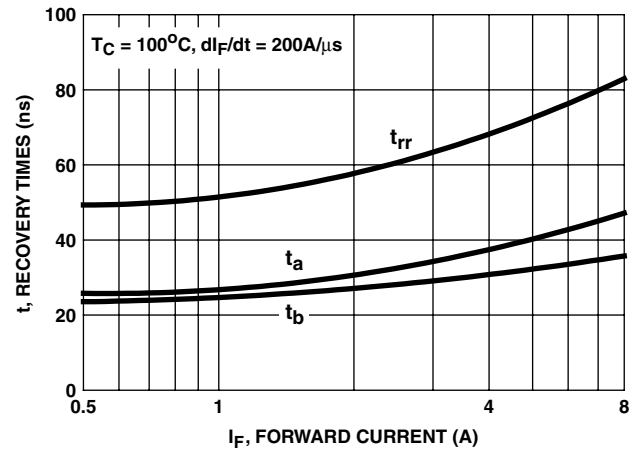

FIGURE 4. t_{rr} , t_a AND t_b CURVES vs FORWARD CURRENT

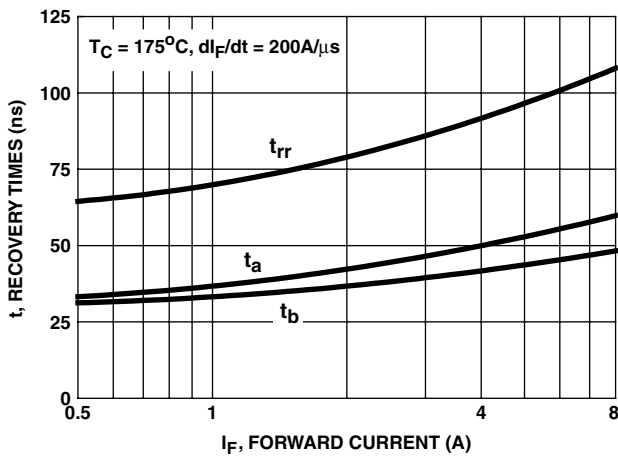

FIGURE 5. t_{rr} , t_a AND t_b CURVES vs FORWARD CURRENT

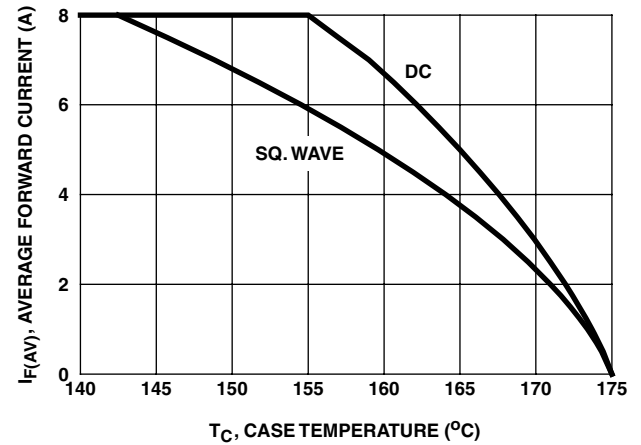

FIGURE 6. CURRENT DERATING CURVE

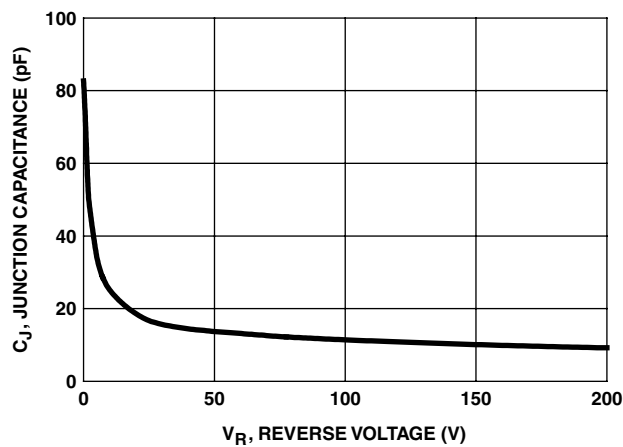

FIGURE 7. JUNCTION CAPACITANCE vs REVERSE VOLTAGE

Test Circuits and Waveforms

V_{GE} AMPLITUDE AND
 R_G CONTROL di_F/dt
 t_1 AND t_2 CONTROL I_F

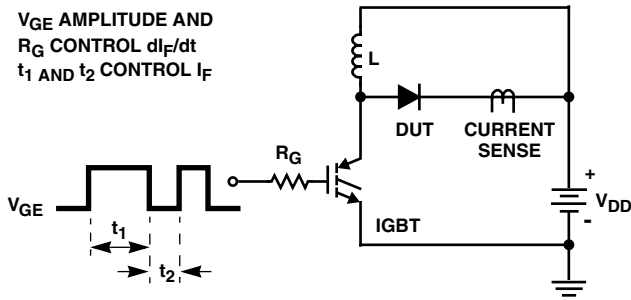

FIGURE 8. t_{rr} TEST CIRCUIT

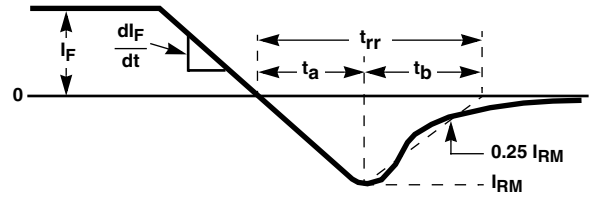

FIGURE 9. t_{rr} WAVEFORMS AND DEFINITIONS

$I = 1A$
 $L = 40mH$
 $R < 0.1\Omega$
 $E_{AVL} = 1/2LI^2 [V_{R(AVL)}/(V_{R(AVL)} - V_{DD})]$
 $Q_1 = IGBT (BV_{CES} > DUT V_{R(AVL)})$

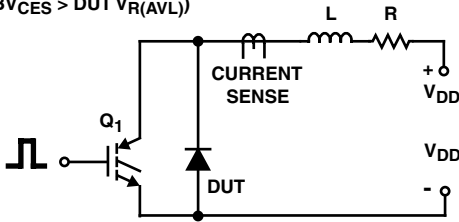

FIGURE 10. AVALANCHE ENERGY TEST CIRCUIT

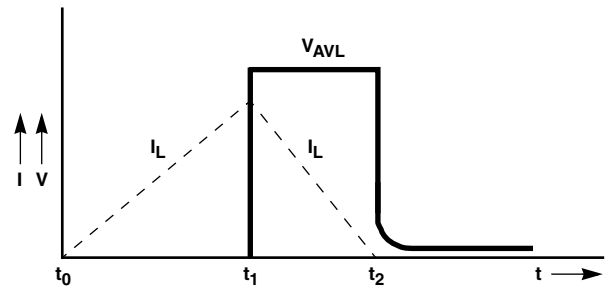

FIGURE 11. AVALANCHE CURRENT AND VOLTAGE WAVEFORMS

TRADEMARKS

The following are registered and unregistered trademarks Fairchild Semiconductor owns or is authorized to use and is not intended to be an exhaustive list of all such trademarks.

| | | | | |
|-----------------------------------|----------------------------------|----------------------------------|------------------------------|-------------------|
| ACE _x TM | FAST [®] | OPTOLOGIC TM | SMART START TM | VCX TM |
| Bottomless TM | FAST _r TM | OPTOPLANAR TM | STAR*POWER TM | |
| CoolFET TM | FRFET TM | PACMAN TM | Stealth TM | |
| CROSSVOLT TM | GlobalOptoisolator TM | POP TM | SuperSOT TM -3 | |
| DenseTrench TM | GTO TM | Power247 TM | SuperSOT TM -6 | |
| DOMET TM | HiSeC TM | PowerTrench [®] | SuperSOT TM -8 | |
| EcoSPARK TM | ISOPLANAR TM | QFET TM | SyncFET TM | |
| E ² CMOS TM | LittleFET TM | QST TM | TinyLogic TM | |
| EnSigna TM | MicroFET TM | QT Optoelectronics TM | TruTranslation TM | |
| FACT TM | MicroPak TM | Quiet Series TM | UHC TM | |
| FACT Quiet Series TM | MICROWIRE TM | SILENT SWITCHER [®] | UltraFET [®] | |

STAR*POWER is used under license

DISCLAIMER

FAIRCHILD SEMICONDUCTOR RESERVES THE RIGHT TO MAKE CHANGES WITHOUT FURTHER NOTICE TO ANY PRODUCTS HEREIN TO IMPROVE RELIABILITY, FUNCTION OR DESIGN. FAIRCHILD DOES NOT ASSUME ANY LIABILITY ARISING OUT OF THE APPLICATION OR USE OF ANY PRODUCT OR CIRCUIT DESCRIBED HEREIN; NEITHER DOES IT CONVEY ANY LICENSE UNDER ITS PATENT RIGHTS, NOR THE RIGHTS OF OTHERS.

LIFE SUPPORT POLICY

FAIRCHILD'S PRODUCTS ARE NOT AUTHORIZED FOR USE AS CRITICAL COMPONENTS IN LIFE SUPPORT DEVICES OR SYSTEMS WITHOUT THE EXPRESS WRITTEN APPROVAL OF FAIRCHILD SEMICONDUCTOR CORPORATION.

As used herein:

1. Life support devices or systems are devices or systems which, (a) are intended for surgical implant into the body, or (b) support or sustain life, or (c) whose failure to perform when properly used in accordance with instructions for use provided in the labeling, can be reasonably expected to result in significant injury to the user.
2. A critical component is any component of a life support device or system whose failure to perform can be reasonably expected to cause the failure of the life support device or system, or to affect its safety or effectiveness.

PRODUCT STATUS DEFINITIONS

Definition of Terms

| Datasheet Identification | Product Status | Definition |
|--------------------------|------------------------|---|
| Advance Information | Formative or In Design | This datasheet contains the design specifications for product development. Specifications may change in any manner without notice. |
| Preliminary | First Production | This datasheet contains preliminary data, and supplementary data will be published at a later date. Fairchild Semiconductor reserves the right to make changes at any time without notice in order to improve design. |
| No Identification Needed | Full Production | This datasheet contains final specifications. Fairchild Semiconductor reserves the right to make changes at any time without notice in order to improve design. |
| Obsolete | Not In Production | This datasheet contains specifications on a product that has been discontinued by Fairchild semiconductor. The datasheet is printed for reference information only. |