



**Major Ratings and Characteristics**

Characteristics	30WQ04FN	Units
$I_{F(AV)}$ Rectangular waveform	3.5	A
$V_{RRM}$	40	V
$I_{FSM}$ @ $t_p = 5 \mu s$ sine	500	A
$V_F$ @ 3 Apk, $T_J = 125^\circ C$	0.49	V
$T_J$	-40 to 150	$^\circ C$

**Description/ Features**

The 30WQ04FN surface mount Schottky rectifier has been designed for applications requiring low forward drop and small foot prints on PC board. Typical applications are in disk drives, switching power supplies, converters, free-wheeling diodes, battery charging, and reverse battery protection.

- Popular D-PAK outline
- Small foot print, surface mountable
- Low forward voltage drop
- High frequency operation
- Guard ring for enhanced ruggedness and long term reliability

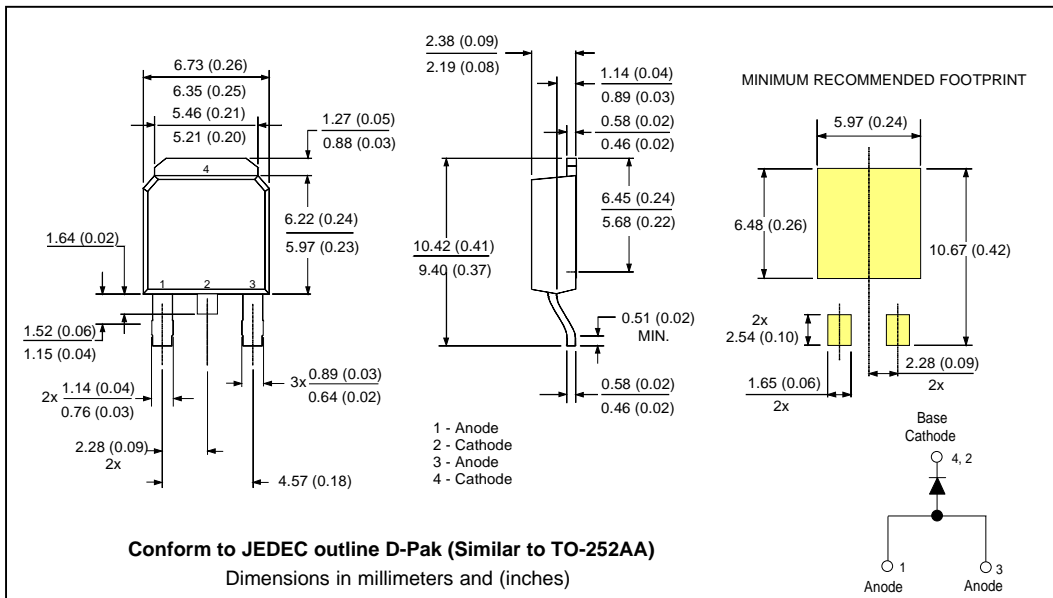

## Voltage Ratings

Part number	30WQ04FN
$V_R$ Max. DC Reverse Voltage (V)	40
$V_{RWM}$ Max. Working Peak Reverse Voltage (V)	

## Absolute Maximum Ratings

Parameters	30WQ...	Units	Conditions
$I_{F(AV)}$ Max. Average Forward Current * See Fig. 5	3.5	A	50% duty cycle @ $T_C = 135^\circ\text{C}$ , rectangular wave form
$I_{FSM}$ Max. Peak One Cycle Non-Repetitive Surge Current * See Fig. 7	500	A	Following any rated load condition and with rated $V_{RRM}$ applied
	80		
$E_{AS}$ Non-Repetitive Avalanche Energy	8.0	mJ	$T_J = 25^\circ\text{C}$ , $I_{AS} = 1$ Amp, $L = 16$ mH
$I_{AR}$ Repetitive Avalanche Current	1.0	A	Current decaying linearly to zero in 1 $\mu\text{sec}$ Frequency limited by $T_J$ max. $V_A = 1.5 \times V_R$ typical

## Electrical Specifications

Parameters	30WQ...	Units	Conditions
$V_{FM}$ Max. Forward Voltage Drop * See Fig. 1 (1)	0.53	V	@ 3A $T_J = 25^\circ\text{C}$
	0.67	V	@ 6A
	0.49	V	@ 3A $T_J = 125^\circ\text{C}$
	0.62	V	@ 6A
$I_{RM}$ Max. Reverse Leakage Current * See Fig. 2 (1)	2	mA	$T_J = 25^\circ\text{C}$
	24	mA	$T_J = 125^\circ\text{C}$
$V_{F(TO)}$ Threshold Voltage	0.34	V	$T_J = T_J$ max.
$r_t$ Forward Slope Resistance	37.33	m $\Omega$	
$C_T$ Typical Junction Capacitance	189	pF	$V_R = 5V_{DC}$ , (test signal range 100Khz to 1Mhz) $25^\circ\text{C}$
$L_S$ Typical Series Inductance	5.0	nH	Measured lead to lead 5mm from package body
dv/dt Max. Voltage Rate of Change	10000	V/ $\mu\text{s}$	(Rated $V_R$ )

(1) Pulse Width < 300 $\mu\text{s}$ , Duty Cycle < 2%

## Thermal-Mechanical Specifications

Parameters	30WQ...	Units	Conditions
$T_J$ Max. Junction Temperature Range (*)	-40 to 150	$^\circ\text{C}$	
$T_{stg}$ Max. Storage Temperature Range	-40 to 150	$^\circ\text{C}$	
$R_{thJC}$ Max. Thermal Resistance Junction to Case	4.7	$^\circ\text{C/W}$	DC operation * See Fig. 4
wt Approximate Weight	0.3(0.01)	g(oz.)	
Case Style	D-PAK		Similar to TO-252AA

(\*)  $\frac{dP_{tot}}{dT_J} < \frac{1}{R_{th(j-a)}}$  thermal runaway condition for a diode on its own heatsink

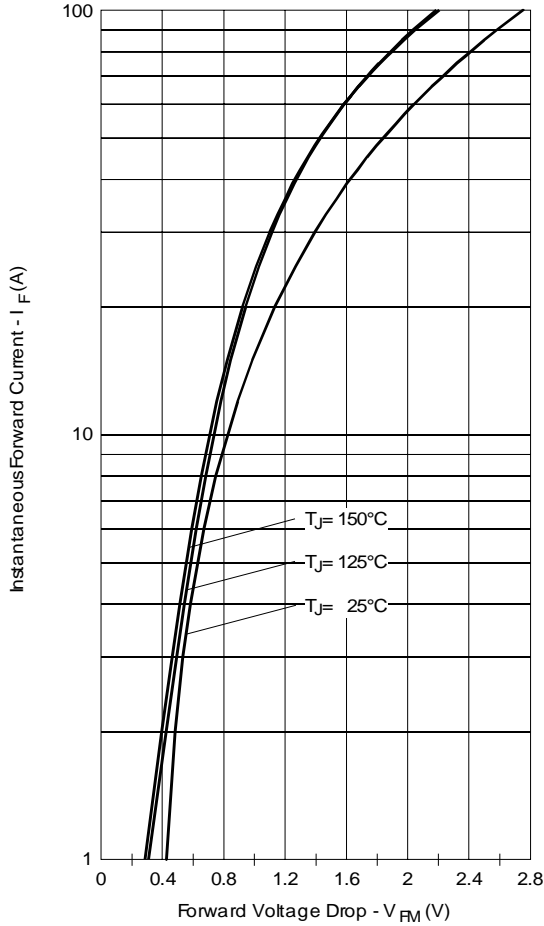

Fig. 1 - Maximum Forward Voltage Drop Characteristics

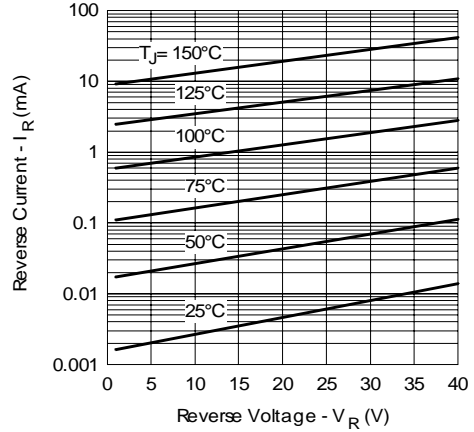

Fig. 2 - Typical Values of Reverse Current Vs. Reverse Voltage

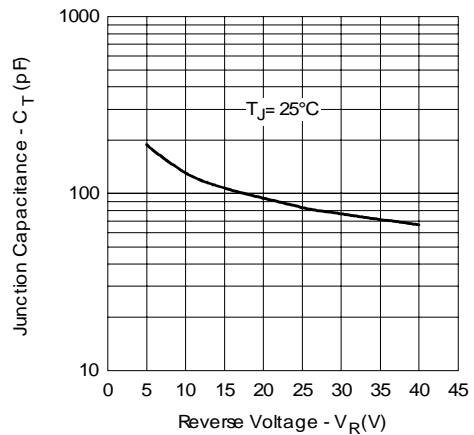

Fig. 3 - Typical Junction Capacitance Vs. Reverse Voltage

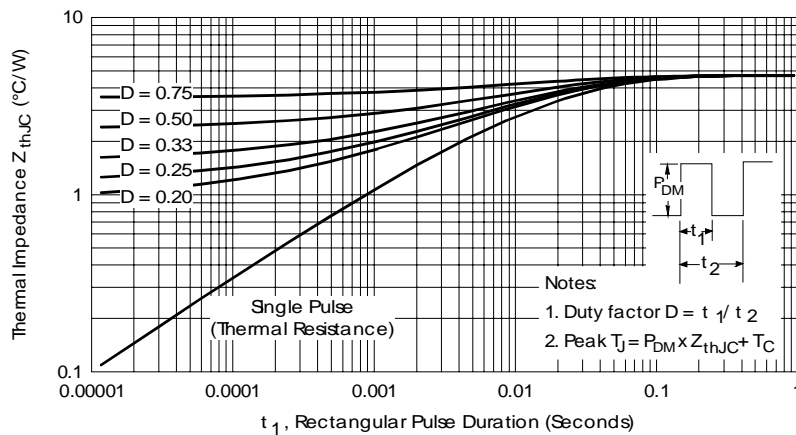

Fig. 4 - Maximum Thermal Impedance  $Z_{thJC}$  Characteristics

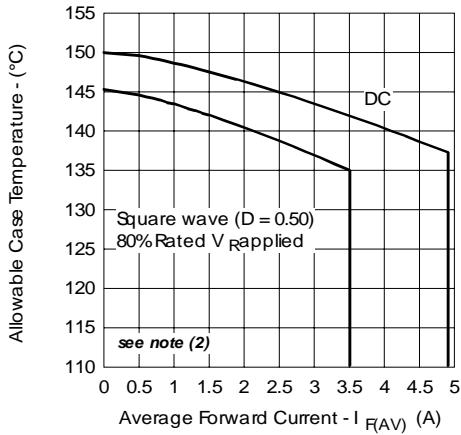

Fig. 5 - Maximum Allowable Case Temperature Vs. Average Forward Current

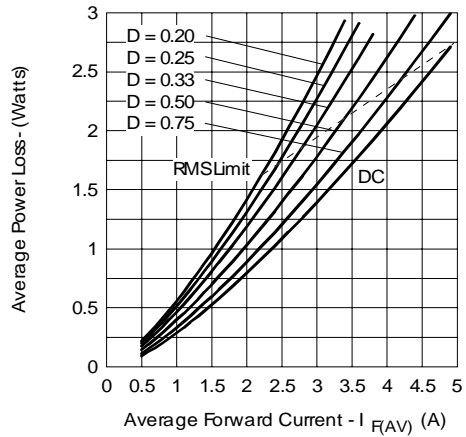

Fig. 6 - Forward Power Loss Characteristics

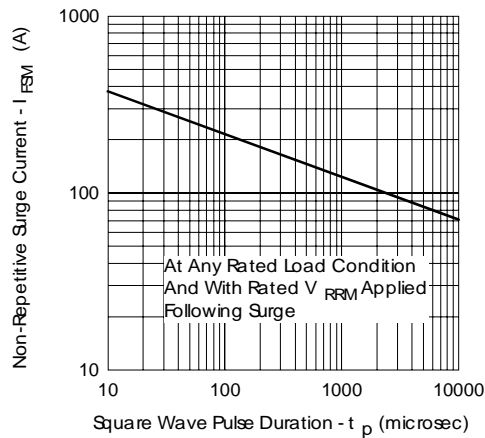

Fig. 7 - Maximum Non-Repetitive Surge Current

(2) Formula used:  $T_c = T_j - (P_d + P_{d_{REV}}) \times R_{thJC}$ ;

$P_d = \text{Forward Power Loss} = I_{F(AV)} \times V_{FM} @ (I_{F(AV)} / D)$  (see Fig. 6);

$P_{d_{REV}} = \text{Inverse Power Loss} = V_{R1} \times I_R (1 - D)$ ;  $I_R @ V_{R1} = 80\% \text{ rated } V_R$

Marking Information

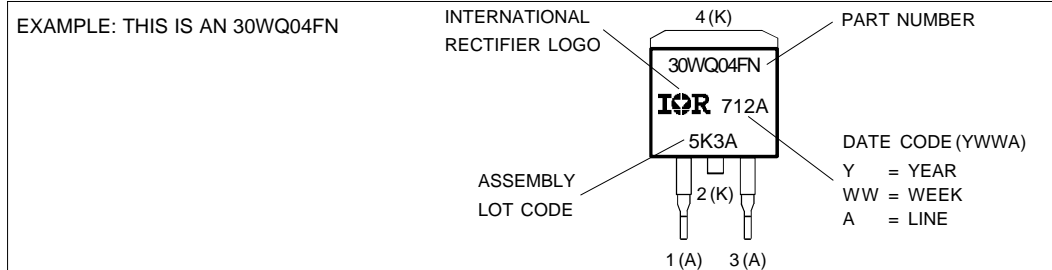

Tape & Reel Information

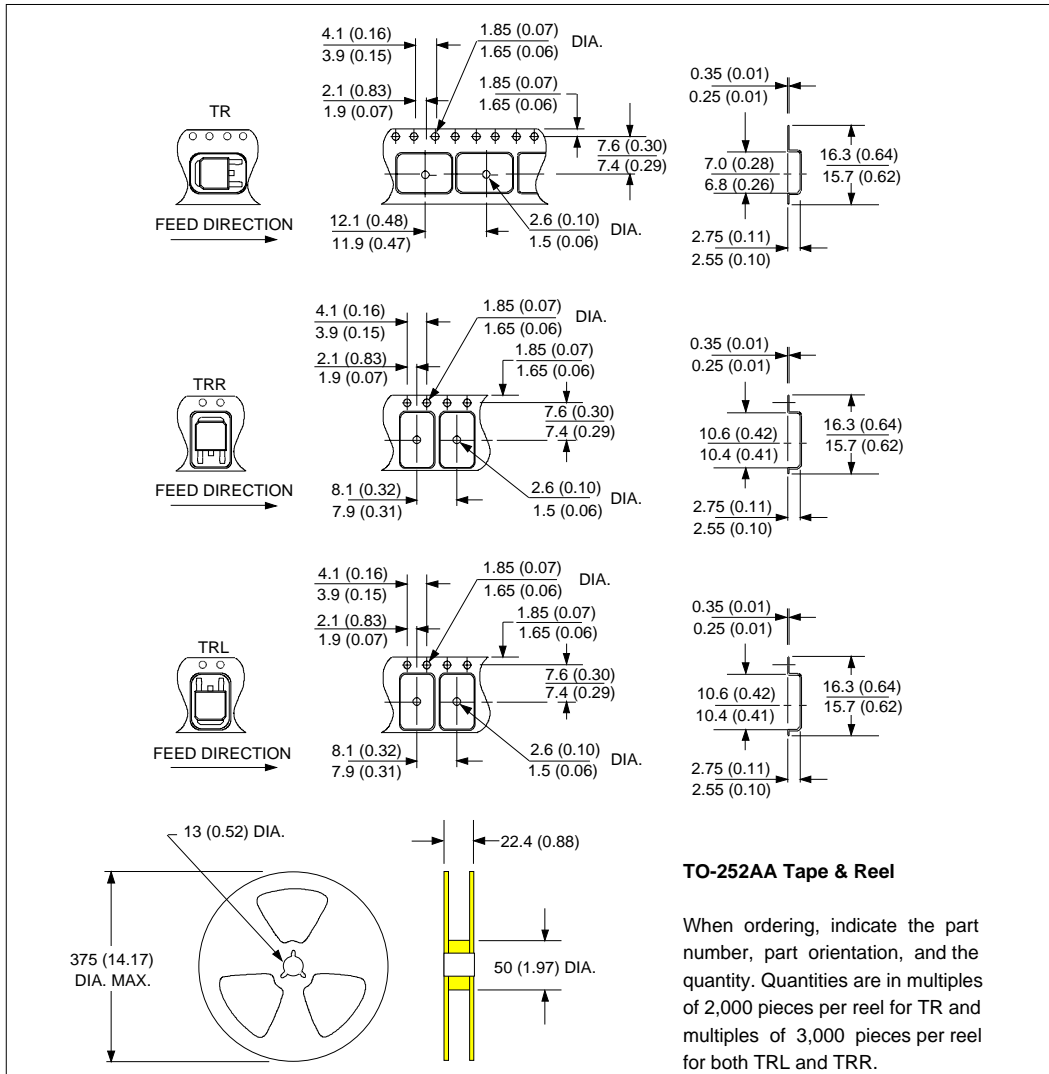

```

30WQ04FN
*****
* This model has been developed by *
* Wizard SPICE MODEL GENERATOR (1999) *
* (International Rectifier Corporation) *
* contains Proprietary Information *
*****
* SPICE Model Diode is composed by a *
* simple diode plus paralalled VCG2T *
*****
.SUBCKT 30WQ04FN ANO CAT
D1 ANO 1 DMOD (0.01614)
*Define diode model
.MODEL DMOD D(IS=1.1021044955238E-04A,N=1.03763733127871,BV=53V,
+ IBV=0.225832353615935A,RS= 0.000439008,CJO=6.29671162330771E-08,
+ VJ=0.169606385579256,XTI=2, EG=0.72244495735053)
*****
*Implementation of VCG2T
VX 1 2 DC 0V
R1 2 CAT TRES 1E-6
.MODEL TRES RES(R=1,TC1=96.5402599365199)
GP1 ANO CAT VALUE={-ABS(I(VX))*EXP(((((-3.005809E-03/96.54026)*((V(2,CAT)*1E6)/(I(VX)+1E-6)-
1))+1)*6.266778E-02*ABS(V(ANO,CAT)))-1)}
*****
.ENDS 30WQ04FN

Thermal Model Subcircuit
.SUBCKT 30WQ04FN 5 1

CTHERM1 5 4 8.75E-04
CTHERM2 4 3 5.09E+01
CTHERM3 3 2 3.62E+02
CTHERM4 2 1 2.35E+03

R THERM1 5 4 1.00E-07
R THERM2 4 3 2.07E+00
R THERM1 3 2 1.92E+00
R THERM1 2 1 7.07E-01

.ENDS 30WQ04FN

```

Data and specifications subject to change without notice.  
This product has been designed and qualified for Industrial Level.  
Qualification Standards can be found on IR's Web site.

International  
IR Rectifier

IR WORLD HEADQUARTERS: 233 Kansas St., El Segundo, California 90245, USA Tel: (310) 252-7105  
TAC Fax: (310) 252-7309  
Visit us at [www.irf.com](http://www.irf.com) for sales contact information. 03/03