

# International IR Rectifier

60EPU04  
60APU04

## Ultrafast Soft Recovery Diode

### Features

- Ultrafast Recovery
- 175°C Operating Junction Temperature

### Benefits

- Reduced RFI and EMI
- Higher Frequency Operation
- Reduced Snubbing
- Reduced Parts Count

$t_{rr} = 50\text{ns (typ)}$
$I_{F(AV)} = 60\text{Amp}$
$V_R = 400\text{V}$

### Description/ Applications


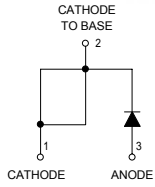

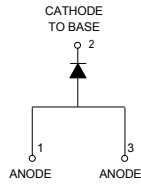
These diodes are optimized to reduce losses and EMI/ RFI in high frequency power conditioning systems. The softness of the recovery eliminates the need for a snubber in most applications. These devices are ideally suited for HF welding, power converters and other applications where switching losses are not significant portion of the total losses.

### Absolute Maximum Ratings

Parameters	Max	Units
$V_R$ Cathode to Anode Voltage	400	V
$I_{F(AV)}$ Continuous Forward Current, $T_C = 127^\circ\text{C}$	60	A
$I_{FSM}$ Single Pulse Forward Current, $T_C = 25^\circ\text{C}$	600	
$I_{FRM}$ ① Maximum Repetitive Forward Current	120	
$T_J, T_{STG}$ Operating Junction and Storage Temperatures	- 55 to 175	$^\circ\text{C}$

① Square Wave, 20kHz

### Case Styles

<p>60EPU04</p>   <p>CATHODE TO BASE</p> <p>CATHODE ANODE</p> <p>TO-247AC (Modified)</p>	<p>60APU04</p>   <p>CATHODE TO BASE</p> <p>ANODE ANODE</p> <p>TO-247AC</p>
---	--

**Electrical Characteristics @  $T_J = 25^\circ\text{C}$  (unless otherwise specified)**

Parameters	Min	Typ	Max	Units	Test Conditions
$V_{BR}, V_r$ Breakdown Voltage, Blocking Voltage	400	-	-	V	$I_R = 100\mu\text{A}$
$V_F$ Forward Voltage	-	1.05	1.25	V	$I_F = 60\text{A}$
	-	0.87	1.03	V	$I_F = 60\text{A}, T_J = 175^\circ\text{C}$
	-	0.93	1.10	V	$I_F = 60\text{A}, T_J = 125^\circ\text{C}$
$I_R$ Reverse Leakage Current	-	-	50	$\mu\text{A}$	$V_R = V_R$ Rated
	-	-	2	$\text{mA}$	$T_J = 150^\circ\text{C}, V_R = V_R$ Rated
$C_T$ Junction Capacitance	-	50	-	$\text{pF}$	$V_R = 400\text{V}$
$L_S$ Series Inductance	-	3.5	-	$\text{nH}$	Measured lead to lead 5mm from package body

**Dynamic Recovery Characteristics @  $T_J = 25^\circ\text{C}$  (unless otherwise specified)**

Parameters	Min	Typ	Max	Units	Test Conditions
$t_{rr}$ Reverse Recovery Time	-	50	60	ns	$I_F = 1\text{A}, di_F/dt = 200\text{A}/\mu\text{s}, V_R = 30\text{V}$
	-	85	-		$T_J = 25^\circ\text{C}$
	-	145	-		$T_J = 125^\circ\text{C}$
$I_{RRM}$ Peak Recovery Current	-	8.8	-	A	$T_J = 25^\circ\text{C}$
	-	15.4	-		$T_J = 125^\circ\text{C}$
$Q_{rr}$ Reverse Recovery Charge	-	375	-	nC	$T_J = 25^\circ\text{C}$
	-	1120	-		$T_J = 125^\circ\text{C}$

$I_F = 60\text{A}$   
 $V_R = 200\text{V}$   
 $di_F/dt = 200\text{A}/\mu\text{s}$

**Thermal - Mechanical Characteristics**

Parameters	Min	Typ	Max	Units
$R_{thJC}$ Thermal Resistance, Junction to Case			0.70	K/W
$R_{thCS}$ ② Thermal Resistance, Case to Heatsink		0.2		
$Wt$ Weight		5.5		g
		0.2		(oz)
$T$ Mounting Torque	1.2		2.4	$\text{N} \cdot \text{m}$
	10		20	$\text{lbf} \cdot \text{in}$

② Mounting Surface, Flat, Smooth and Greased

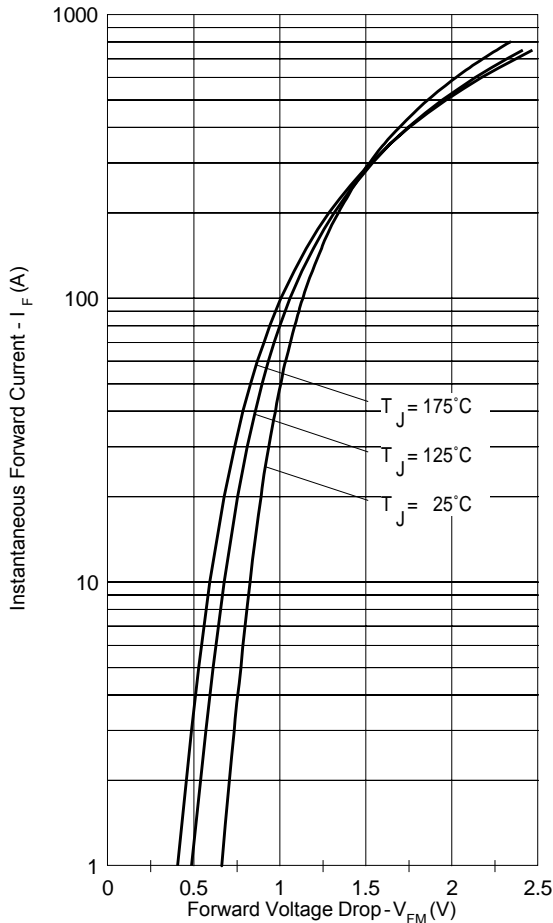


Fig. 1 - Typical Forward Voltage Drop Characteristics

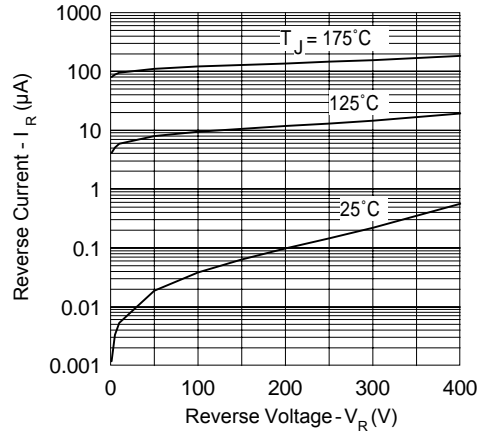


Fig. 2 - Typical Values Of Reverse Current Vs. Reverse Voltage

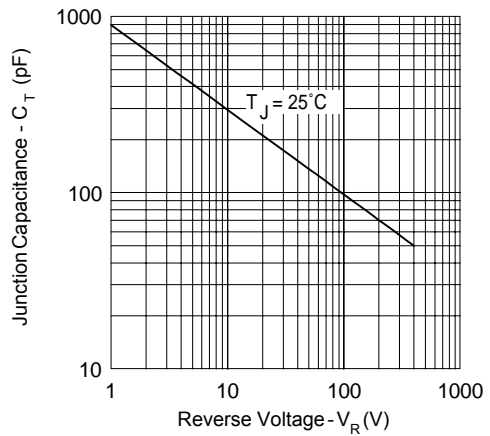


Fig. 3 - Typical Junction Capacitance Vs. Reverse Voltage

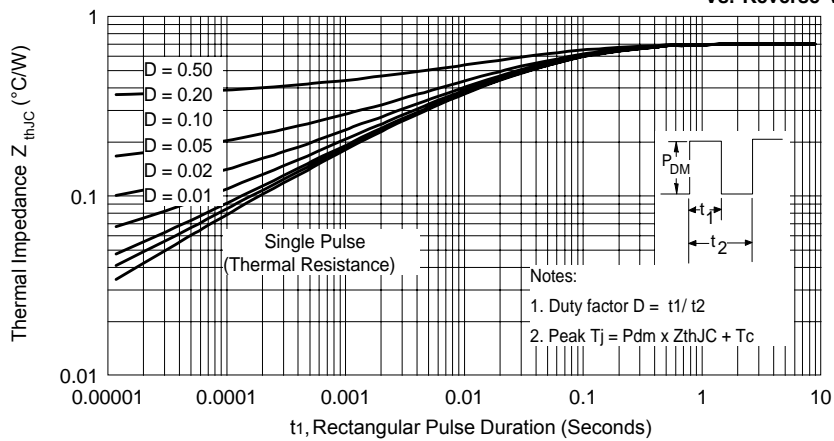
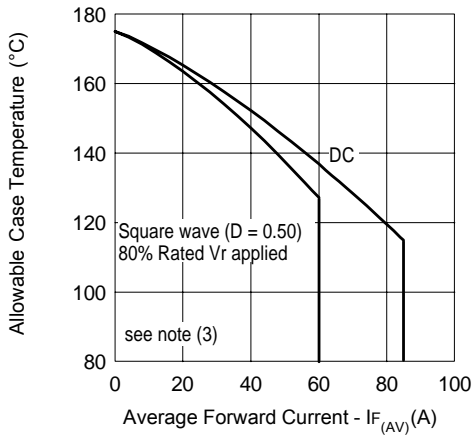
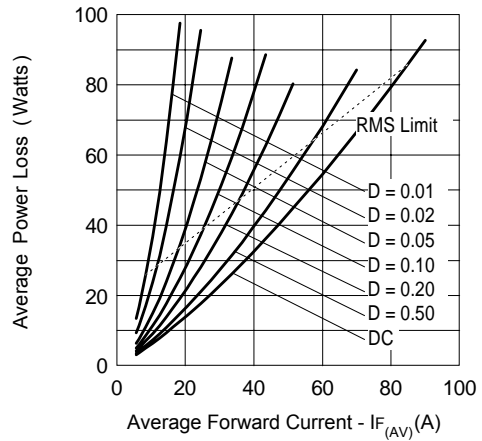


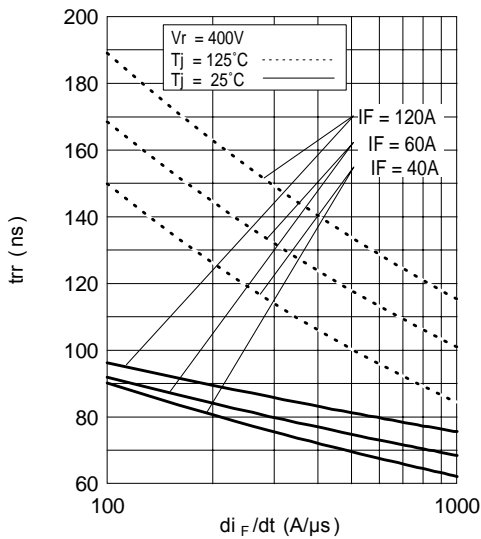
Fig. 4 - Max. Thermal Impedance  $Z_{thJC}$  Characteristics



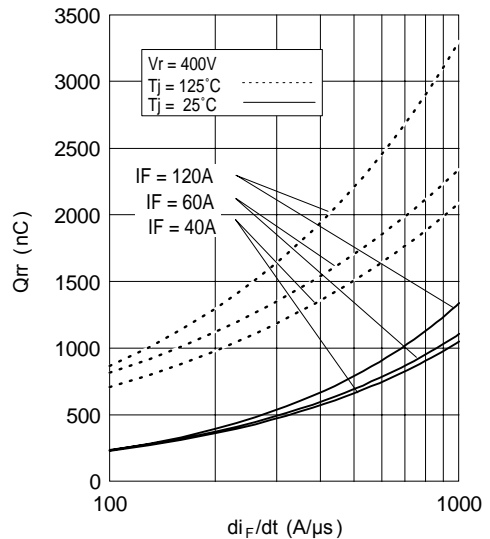
**Fig. 5 - Max. Allowable Case Temperature Vs. Average Forward Current**



**Fig. 6 - Forward Power Loss Characteristics**

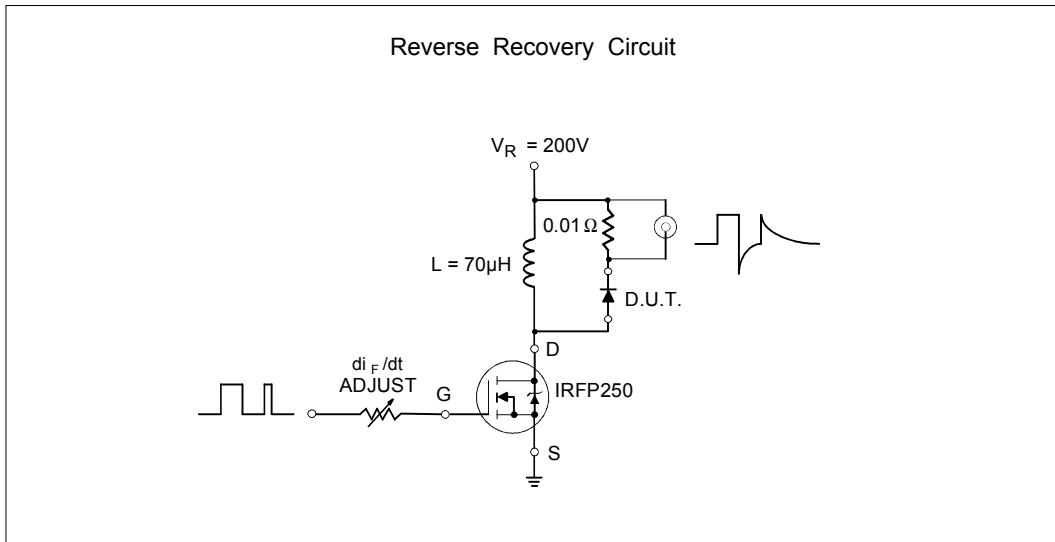


**Fig. 7 - Typical Reverse Recovery time vs. di<sub>F</sub>/dt**

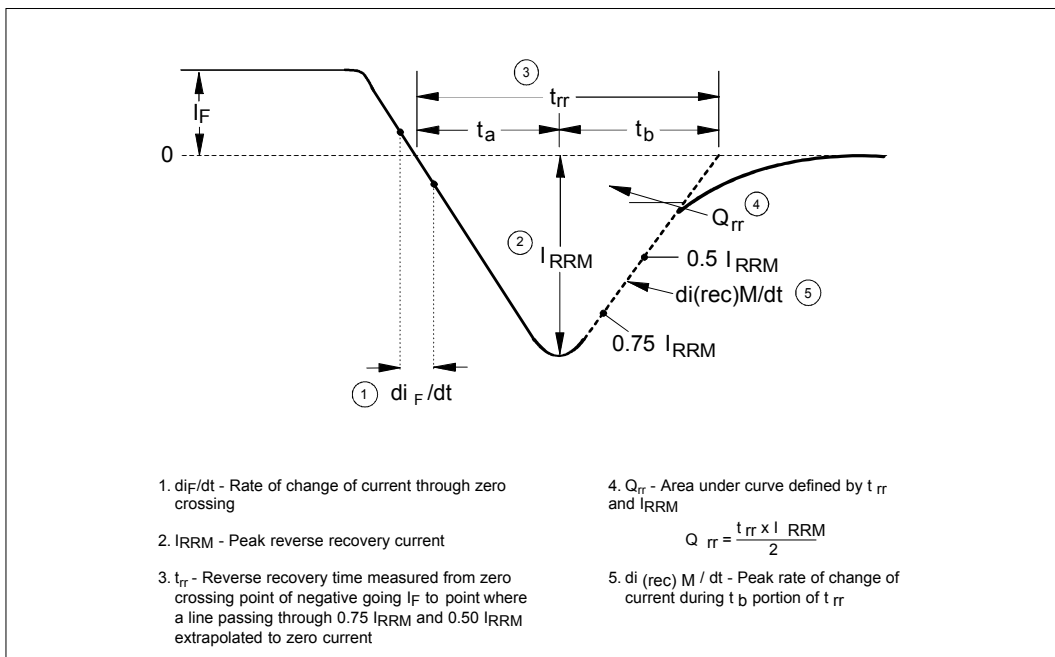


**Fig. 8 - Typical Stored Charge vs. di<sub>F</sub>/dt**

(3) Formula used:  $T_c = T_j - (P_d + P_{d_{REV}}) \times R_{thJC}$ ;  
 $P_d = \text{Forward Power Loss} = I_{F(AV)} \times V_{FM} @ (I_{F(AV)} / D)$  (see Fig. 6);  
 $P_{d_{REV}} = \text{Inverse Power Loss} = V_{R1} \times I_R (1 - D); I_R @ V_{R1} = 80\% \text{ rated } V_R$

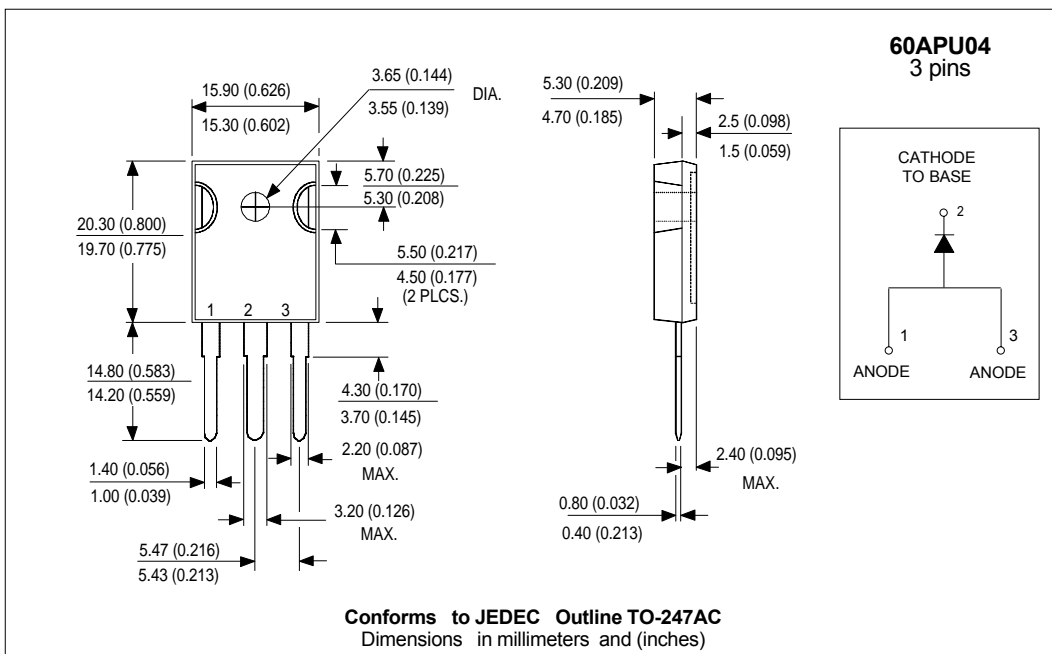
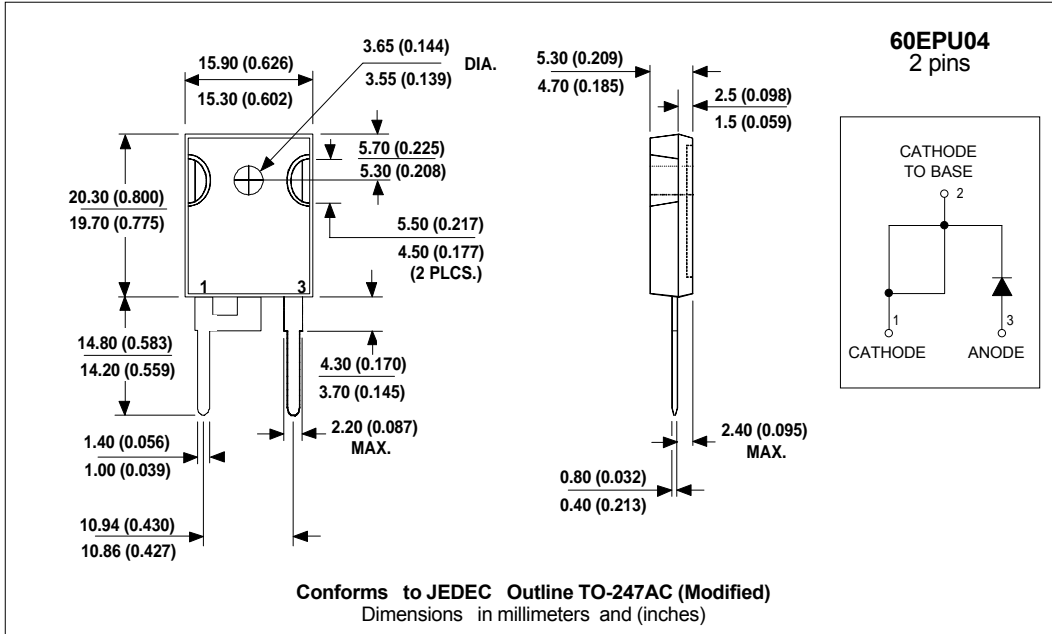


**Fig. 9- Reverse Recovery Parameter Test Circuit**



**Fig. 10 - Reverse Recovery Waveform and Definitions**

Outline Table



Ordering Information Table

**Device Code**

60	E	P	U	04
①	②	③	④	⑤

<b>1</b>	-	Current Rating	(60 = 60A)	E = 2 pins A = 3 pins
<b>2</b>	-	Single Diode		
<b>3</b>	-	TO-247AC (Modified)		
<b>4</b>	-	Ultrafast Recovery		
<b>5</b>	-	Voltage Rating	(04 = 400V)	

Data and specifications subject to change without notice.  
 This product has been designed and qualified for Industrial Level.  
 Qualification Standards can be found on IR's Web site.