

Ultrafast Rectifier

Features

- Two Common-Cathode Diodes
- Ultrafast Reverse Recovery
- Ultrasoft Reverse Recovery Current Shape
- Low Forward Voltage Drop
- Low Leakage Current
- Optimized for Power Conversion: Welding and Industrial SMPS Applications
- Up to 175°C Operating Junction Temperature

$t_{rr} = 38ns$
 $I_{F(AV)} = 70Amp$
 $@T_C = 116^\circ C$
 $V_R = 400V$

Description/ Applications

The 70CRU04 integrates two state-of-the-art International Rectifier's Ultrafast recovery rectifiers in the common-cathode configuration. The planar structure of the diodes, and the platinum doping life-time control, provide a Ultrasoft recovery current shape, together with the best overall performance, ruggedness and reliability characteristics.

These devices are thus intended for high frequency applications in which the switching energy is designed not to be predominant portion of the total energy, such as in the output rectification stage of Welding machines, SMPS, DC-DC converters. Their extremely optimized stored charge and low recovery current reduce both over-dissipation in the switching elements (and snubbers) and EMI/RFI.

Absolute Maximum Ratings

Parameters		Max	Units
V_R	Cathode to Anode Voltage	400	V
$I_{F(AV)}$	Continuous Forward Current $T_C = 116^\circ C$ Per Diode	35	A
I_{FSM}	Single Pulse Forward Current $T_C = 25^\circ C$ Per Diode	300	
P_D	Maximum Power Dissipation $T_C = 100^\circ C$ Per Module	47	W
T_J, T_{STG}	Operating Junction and Storage Temperatures	- 55 to 175	$^\circ C$

Case Styles

70CRU04



TO-218

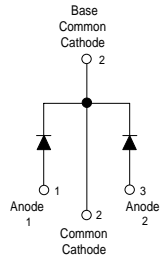

Electrical Characteristics per Diode @ T_J = 25°C (unless otherwise specified)

Parameters	Min	Typ	Max	Units	Test Conditions
V _{BR} , V _r Breakdown Voltage, Blocking Voltage	400	-	-	V	I _R = 100μA
V _F Forward Voltage	-	1.11	1.32	V	I _F = 35A
	-	0.98	1.14	V	I _F = 35A, T _J = 125°C
	-	0.92	1.05	V	I _F = 35A, T _J = 175°C
I _R Reverse Leakage Current	-	-	100	μA	V _R = V _R Rated
	-	-	2	mA	T _J = 150°C, V _R = V _R Rated
C _T Junction Capacitance	-	70	-	pF	V _R = 400V

Dynamic Recovery Characteristics per Diode @ T_J = 25°C (unless otherwise specified)

Parameters	Min	Typ	Max	Units	Test Conditions
t _{rr} Reverse Recovery Time	-	32	38	ns	T _J = 25°C I _F = 1A V _R = 30V di _F /dt = 200A/μs
t _{rr} Reverse Recovery Time	-	72	-	ns	T _J = 25°C
	-	130	-		T _J = 125°C
I _{RRM} Peak Recovery Current	-	7.7	-	A	T _J = 25°C
	-	16.5	-		T _J = 125°C
Q _{rr} Reverse Recovery Charge	-	0.28	-	μC	T _J = 25°C
	-	1.08	-		T _J = 125°C

Thermal - Mechanical Characteristics

Parameters	Min	Typ	Max	Units
R _{thJC} Thermal Resistance, Junction to Case Per Diode	-	0.8	1.6	K/W
R _{thJC} Thermal Resistance, Junction to Case Both Diodes	-	0.4	0.8	
R _{thCS} ⁽¹⁾ Thermal Resistance, Case to Heatsink	-	0.2	-	
Wt Weight	-	4	-	g
	-	0.13	-	(oz)
T Mounting Torque	1.2	-	2.4	N * m
	10	-	20	lbf.in

(1) Mounting Surface, Flat, Smooth and Greased

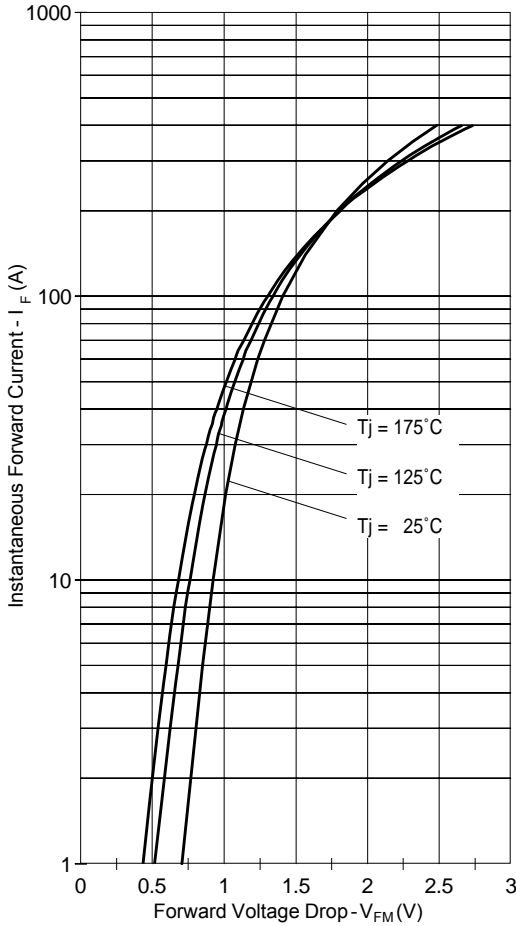

Fig. 1 - Typical Forward Voltage Drop Characteristics (Per Diode)

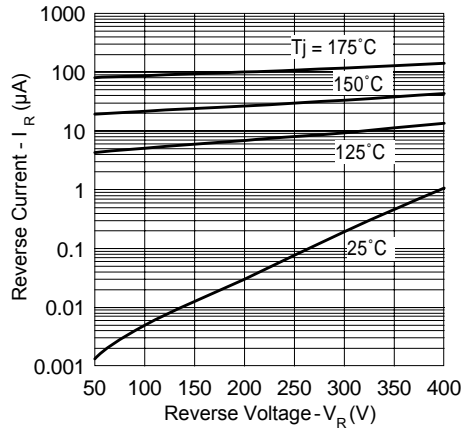

Fig. 2 - Typical Values Of Reverse Current Vs. Reverse Voltage

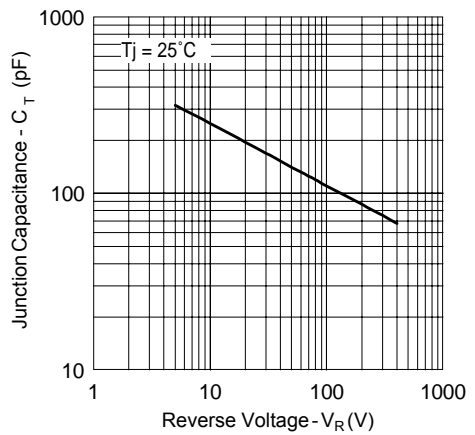

Fig. 3 - Typical Junction Capacitance Vs. Reverse Voltage

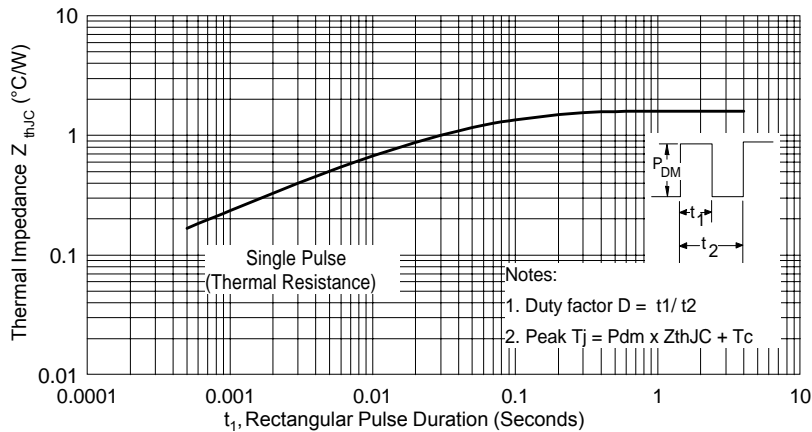

Fig. 4 - Max. Thermal Impedance Z_{thJC} Characteristics (Per Diode)

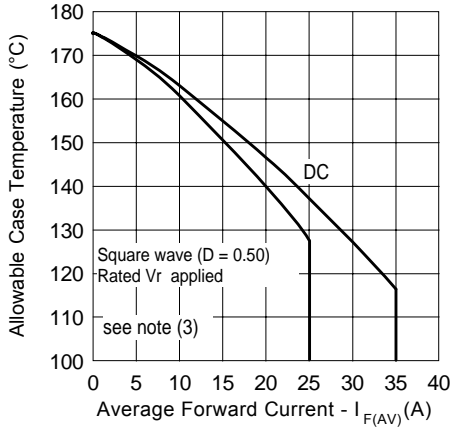

Fig. 5 - Max. Allowable Case Temperature Vs. Average Forward Current

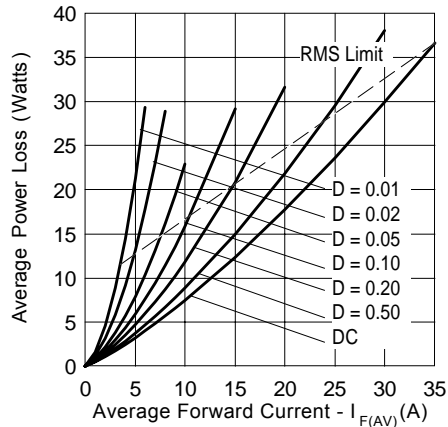

Fig. 6 - Forward Power Loss Characteristics

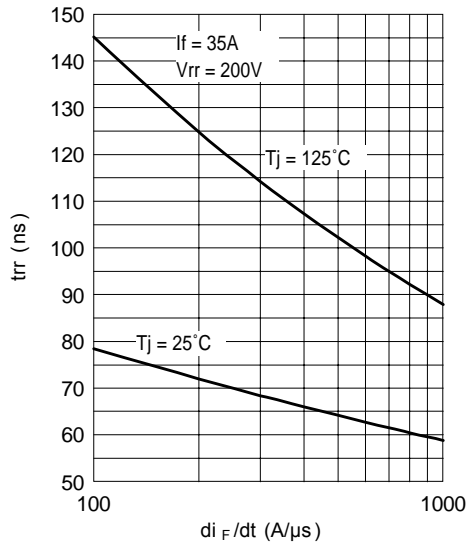

Fig. 7 - Typical Reverse Recovery vs. di_F/dt

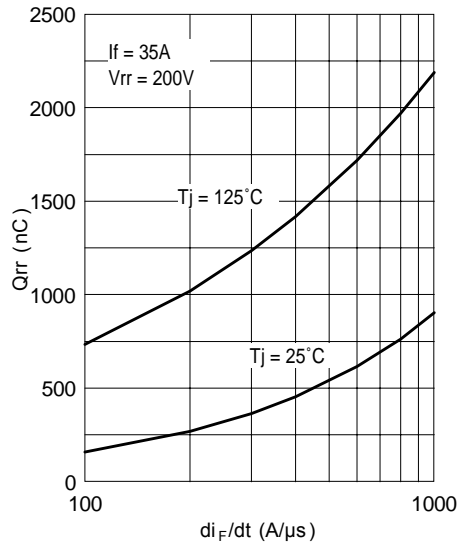
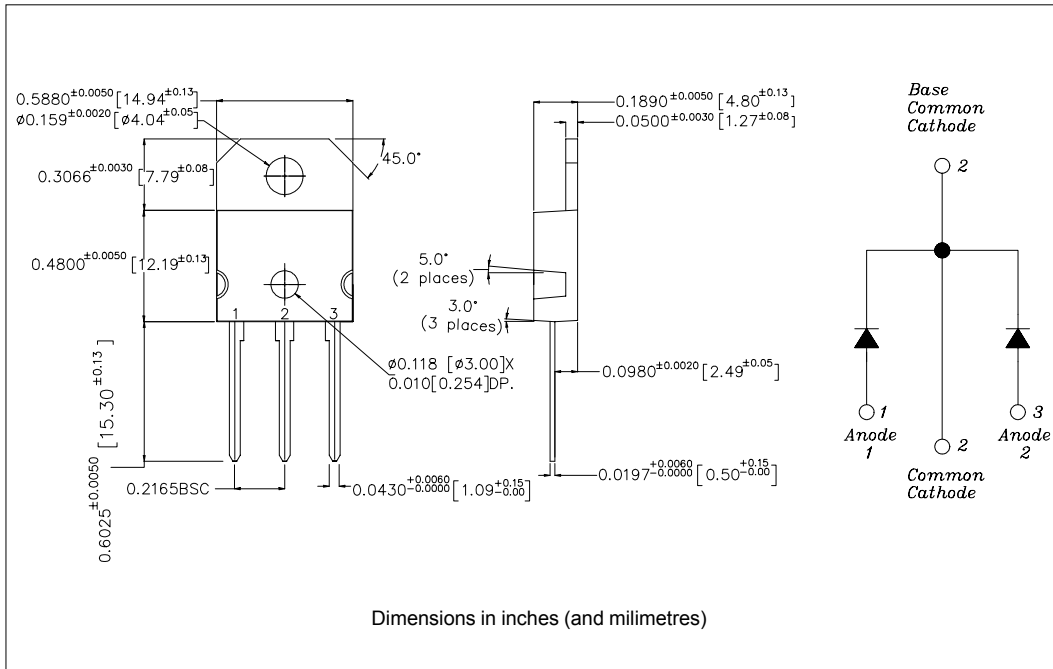

Fig. 8 - Typical Stored Charge vs. di_F/dt

(3) Formula used: $T_C = T_J - (P_d + P_{d_{REV}}) \times R_{thJC}$;
 $P_d = \text{Forward Power Loss} = I_{F(AV)} \times V_{FM} @ (I_{F(AV)}/D)$ (see Fig. 6);
 $P_{d_{REV}} = \text{Inverse Power Loss} = V_{R1} \times I_R (1 - D)$; $I_R @ V_{R1} = \text{rated } V_R$

Outline Table



Marking Information

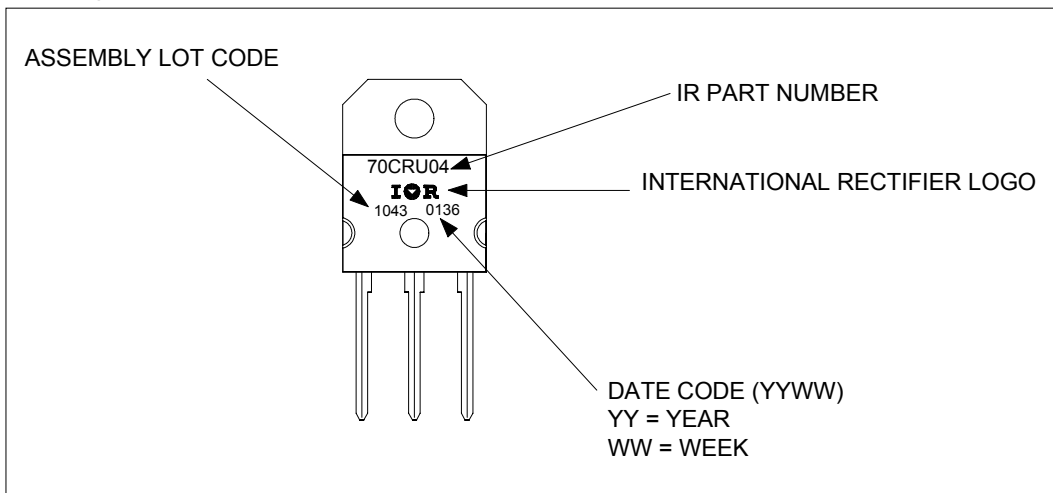

Ordering Information Table

Device Code											
	<table border="1" style="margin: auto;"> <tr> <td style="padding: 5px;">70</td> <td style="padding: 5px;">C</td> <td style="padding: 5px;">R</td> <td style="padding: 5px;">U</td> <td style="padding: 5px;">04</td> </tr> <tr> <td style="text-align: center;">①</td> <td style="text-align: center;">②</td> <td style="text-align: center;">③</td> <td style="text-align: center;">④</td> <td style="text-align: center;">⑤</td> </tr> </table>	70	C	R	U	04	①	②	③	④	⑤
70	C	R	U	04							
①	②	③	④	⑤							
1	- Current Rating (70 = 70A)										
2	- Common Cathode										
3	- TO-218										
4	- Ultrafast Recovery										
5	- Voltage Rating (04 = 400V)										

Data and specifications subject to change without notice.
 This product has been designed and qualified for Industrial Level.
 Qualification Standards can be found on IR's Web site.

International
IOR Rectifier

IR WORLD HEADQUARTERS: 233 Kansas St., El Segundo, California 90245, USA Tel: (310) 252-7105
 TAC Fax: (310) 252-7309
 Visit us at www.irf.com for sales contact information. 12/01