



8ETL06
8ETL06S
8ETL06-1
8ETL06FP

Ultra-low V_F Hyperfast Rectifier for Discontinuous Mode PFC

Features

- Benchmark Ultra-low Forward Voltage Drop
- Hyperfast Recovery Time
- Low Leakage Current
- 175°C Operating Junction Temperature
- Fully Isolated package ($V_{INS} = 2500 V_{RMS}$)
- UL E78996 approved 

$V_F = 0.96V$ typ.
 $I_{F(AV)} = 8Amp$
 $V_R = 600V$

Description

State of the art, ultra-low V_F , soft-switching Hyperfast Rectifiers optimized for Discontinuous (Critical) Mode (DCM) Power Factor Correction (PFC).

The minimised conduction loss, optimized stored charge and low recovery current minimize the switching losses and reduce over dissipation in the switching element and snubbers.

The device is also intended for use as a free wheeling diode in power supplies and other power switching applications.





Applications

AC-DC SMPS 70W-400W

e.g. Laptop & Printer AC Adaptors, Desktop PC, TV & Monitor, Games units and DVD AC-DC power supplies.

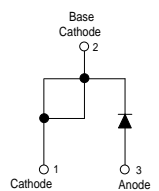
Absolute Maximum Ratings

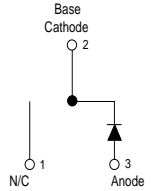
Parameters	Max	Units
V_{RRM} Peak Repetitive Reverse Voltage	600	V
$I_{F(AV)}$ Average Rectified Forward Current @ $T_C = 160^\circ C$	8	A
I_{FSM} Non Repetitive Peak Surge Current @ $T_J = 25^\circ C$	175	
I_{FM} Peak Repetitive Forward Current	16	
T_J, T_{STG} Operating Junction and Storage Temperatures	- 65 to 175	$^\circ C$

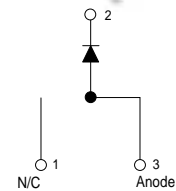
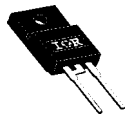
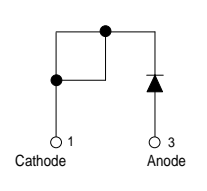
Case Styles			
<p>8ETL06</p>   <p>TO-220AC</p>	<p>8ETL06S</p>   <p>D²PAK</p>	<p>8ETL06-1</p>   <p>TO-262</p>	<p>8ETL06FP</p>   <p>TO-220 FULLPACK</p>

Electrical Characteristics @ T_J = 25°C (unless otherwise specified)

Parameters	Min	Typ	Max	Units	Test Conditions
V _{BR} , V _r Breakdown Voltage, Blocking Voltage	600	-	-	V	I _R = 100μA
V _F Forward Voltage	-	0.96	1.05	V	I _F = 8A, T _J = 25°C
	-	0.81	0.86	V	I _F = 8A, T _J = 150°C
I _R Reverse Leakage Current	-	0.05	5	μA	V _R = V _R Rated
	-	20	100	μA	T _J = 150°C, V _R = V _R Rated
C _T Junction Capacitance	-	17	-	pF	V _R = 600V
L _S Series Inductance	-	8.0	-	nH	Measured lead to lead 5mm from package body

Dynamic Recovery Characteristics @ T_C = 25°C (unless otherwise specified)

Parameters	Min	Typ	Max	Units	Test Conditions
t _{rr} Reverse Recovery Time	-	60	100	ns	I _F = 1A, di _F /dt = 100A/μs, V _R = 30V
	-	150	250		I _F = 8A, di _F /dt = 100A/μs, V _R = 30V
	-	170	-		T _J = 25°C
	-	250	-		T _J = 125°C
I _R RM Peak Recovery Current	-	15	-	A	T _J = 25°C
	-	20	-		T _J = 125°C
Q _{rr} Reverse Recovery Charge	-	1.3	-	μC	T _J = 25°C
	-	2.6	-		T _J = 125°C

I_F = 8A
di_F/dt = 200A/μs
V_R = 390V

Thermal - Mechanical Characteristics

Parameters	Min	Typ	Max	Units
T _J Max. Junction Temperature Range	-	-	175	°C
T _{Stg} Max. Storage Temperature Range	- 65	-	175	
R _{thJC} Thermal Resistance, Junction to Case	-	Per Leg	1.4	°C/W
		Fullpack (Per Leg)	1.6	
R _{thJA} ^① Thermal Resistance, Junction to Ambient	-	-	70	°C/W
R _{thCS} ^② Thermal Resistance, Case to Heatsink	-	Per Leg	0.5	
		Fullpack	1.5	
Weight	-	2.0	-	g
	-	0.07	-	(oz)
Mounting Torque	6.0	-	12	Kg-cm
	5.0	-	10	lbf.in

① Typical Socket Mount

② Mounting Surface, Flat, Smooth and Greased

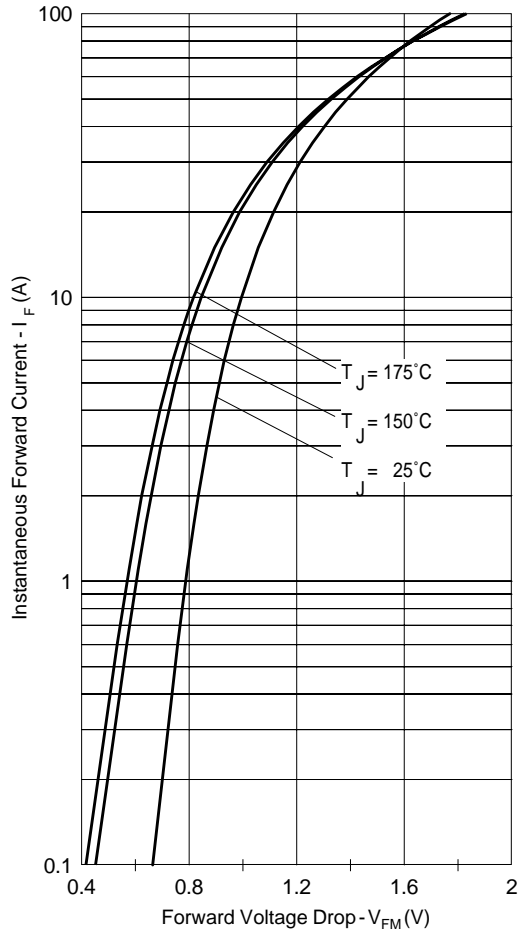

Fig. 1 - Typical Forward Voltage Drop Characteristics

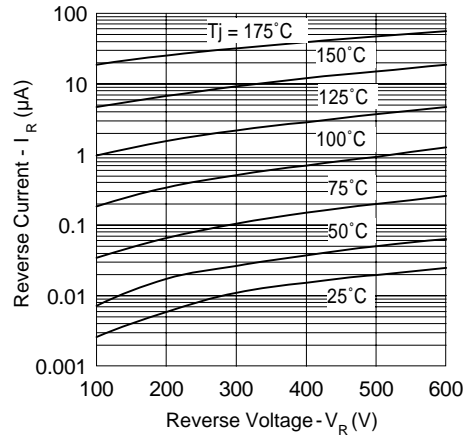

Fig. 2 - Typical Values Of Reverse Current Vs. Reverse Voltage

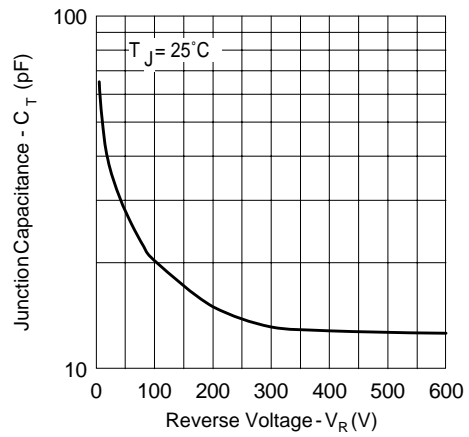

Fig. 3 - Typical Junction Capacitance Vs. Reverse Voltage

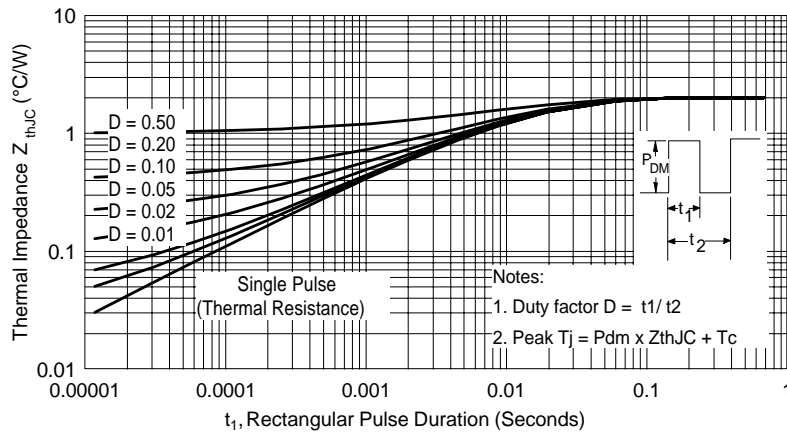

Fig. 4 - Max. Thermal Impedance Z_{thJC} Characteristics

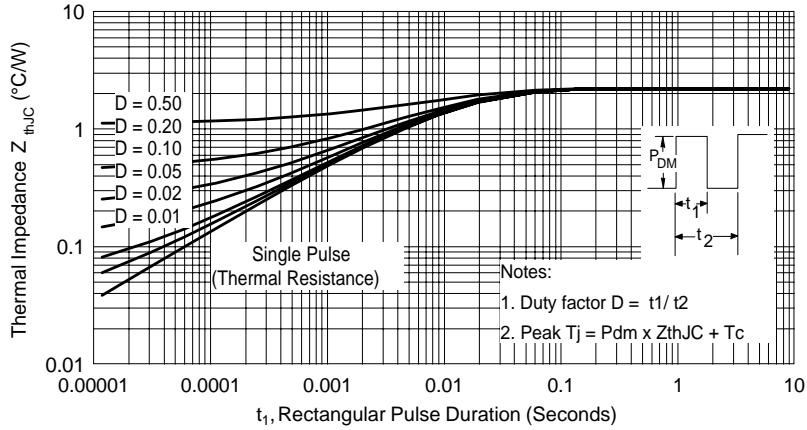

Fig. 5 - Max. Thermal Impedance Z_{thJC} Characteristics (FULLPACK)

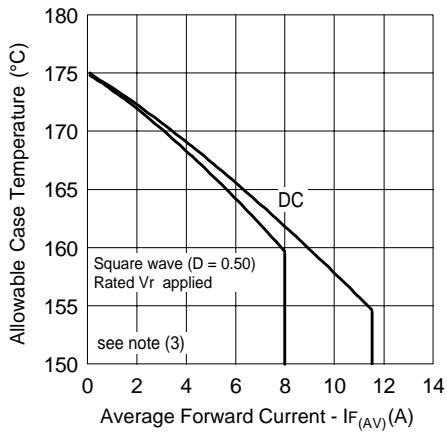

Fig. 6 - Max. Allowable Case Temperature Vs. Average Forward Current

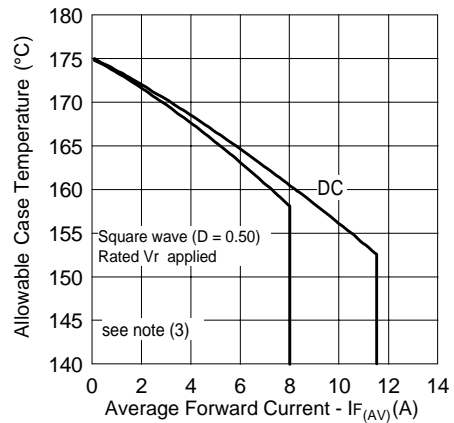

Fig. 7 - Max. Allowable Case Temperature Vs. Average Forward Current (FULLPACK)

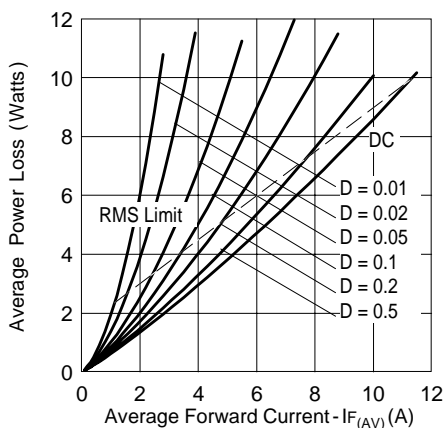

Fig. 8 - Forward Power Loss Characteristics

(3) Formula used: $T_c = T_j - (P_d + P_{d_{REV}}) \times R_{thJC}$;
 P_d = Forward Power Loss =
 $I_{F(AV)} \times V_{FM} @ (I_{F(AV)} / D)$
 (see Fig. 8);
 $P_{d_{REV}}$ = Inverse Power Loss = $V_{R1} \times I_R (1 - D)$;
 $I_R @ V_{R1}$ = rated V_R

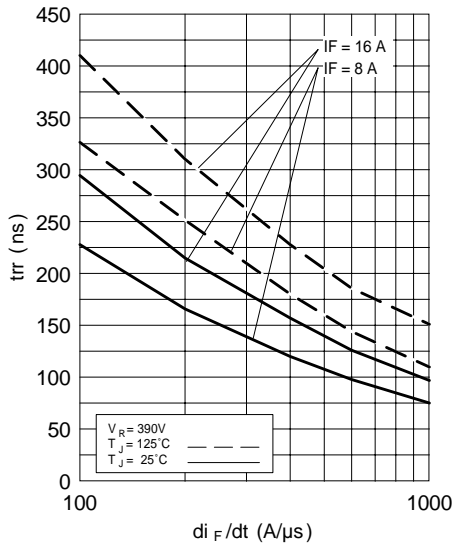

Fig. 9 - Typical Reverse Recovery vs. di_F/dt

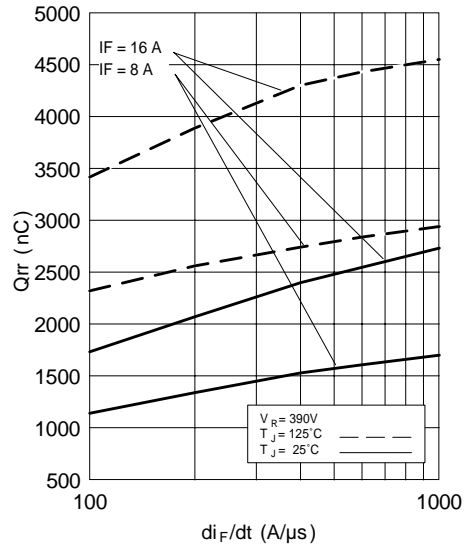

Fig. 10 - Typical Stored Charge vs. di_F/dt

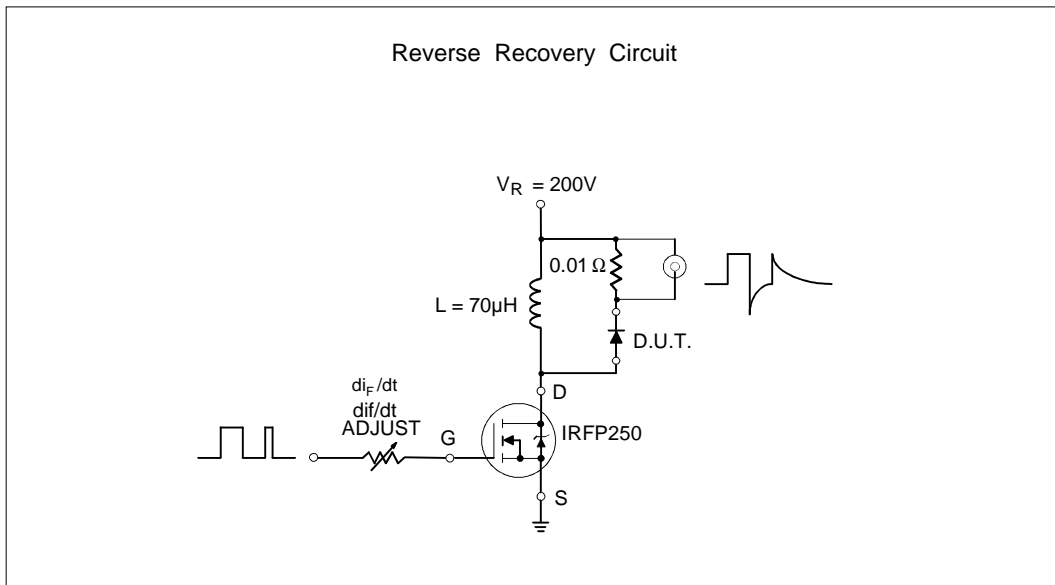

Fig. 11 - Reverse Recovery Parameter Test Circuit

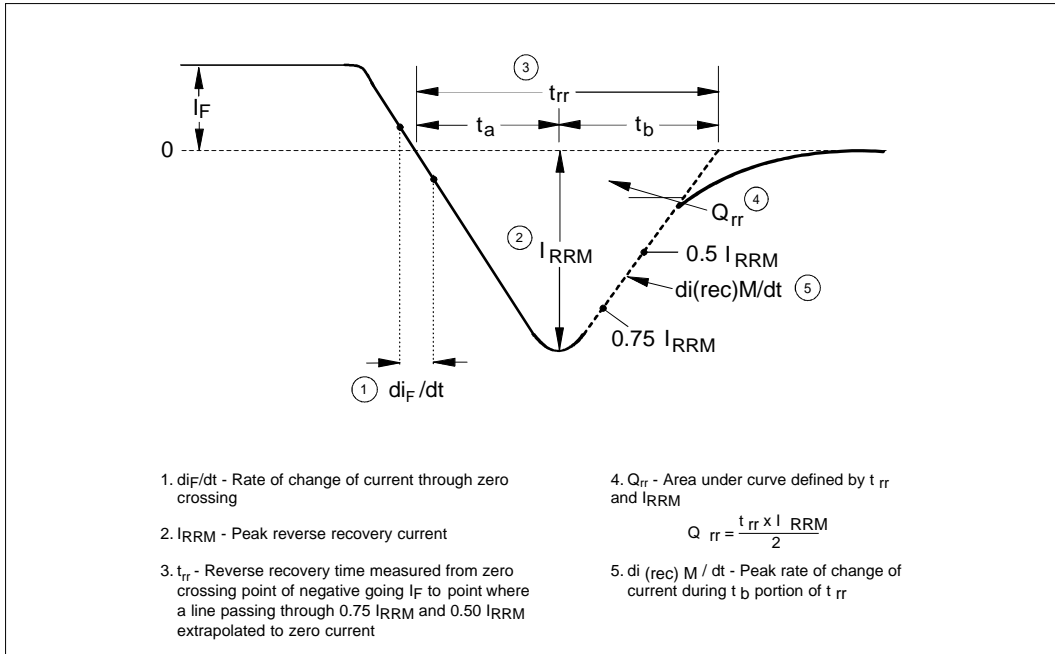
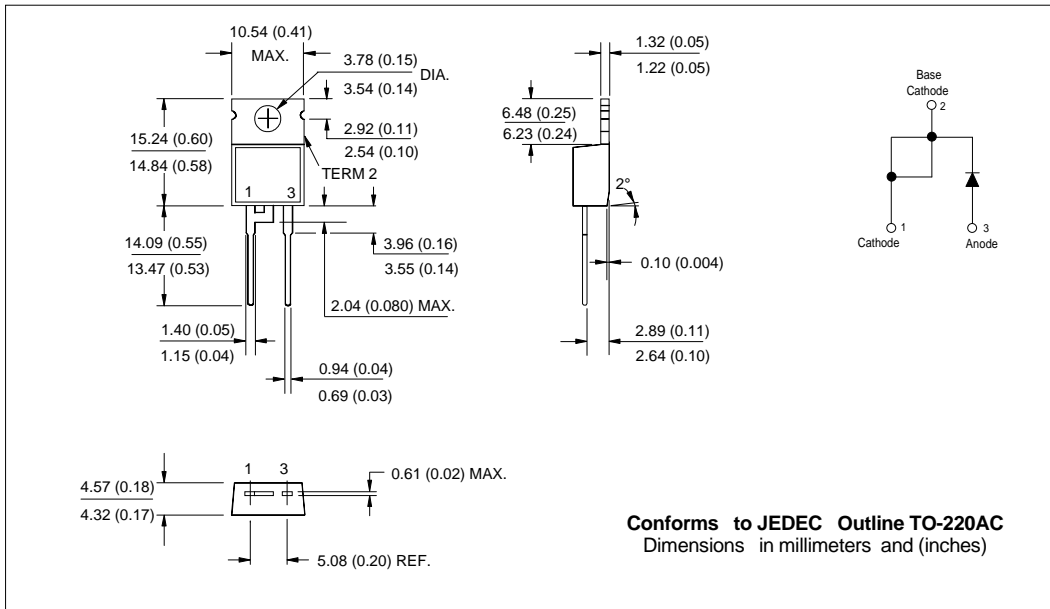
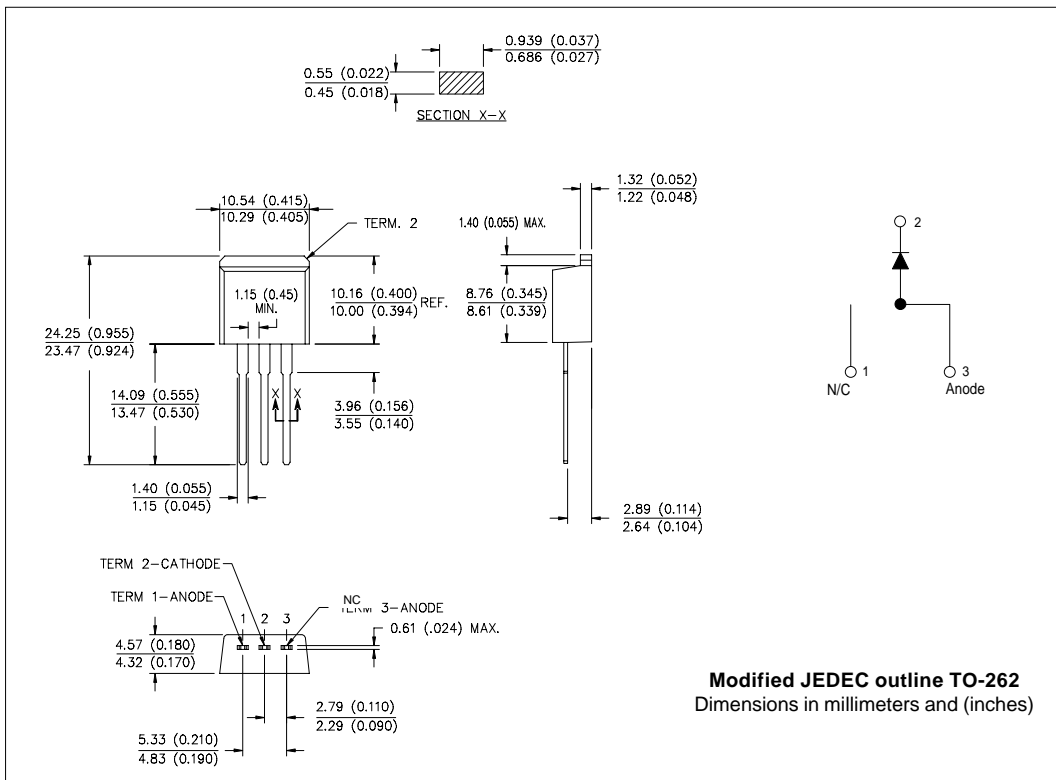
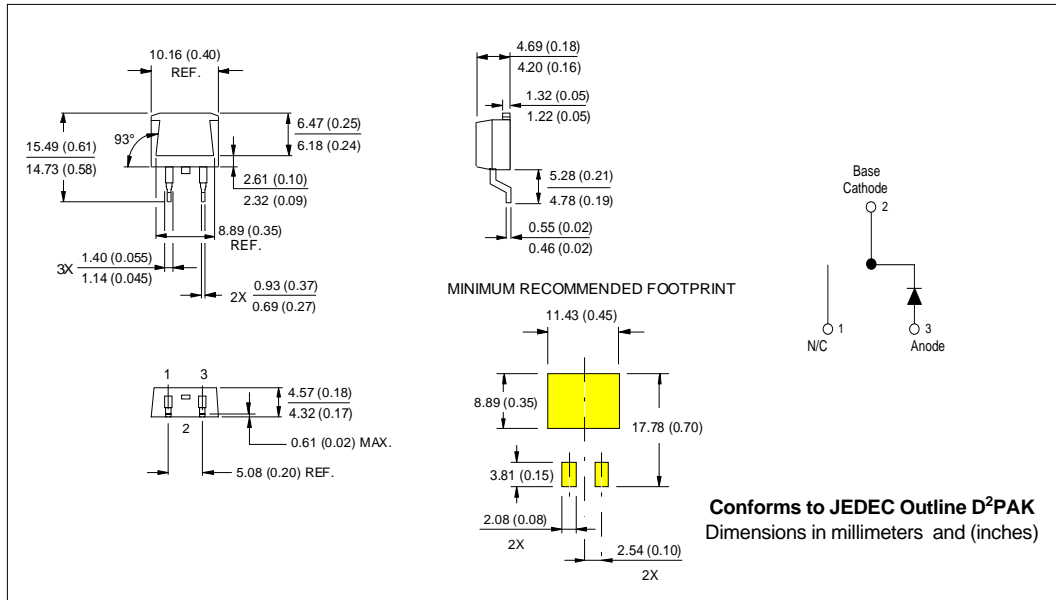

Fig. 12 - Reverse Recovery Waveform and Definitions

Outline Table



Outline Table



Outline Table

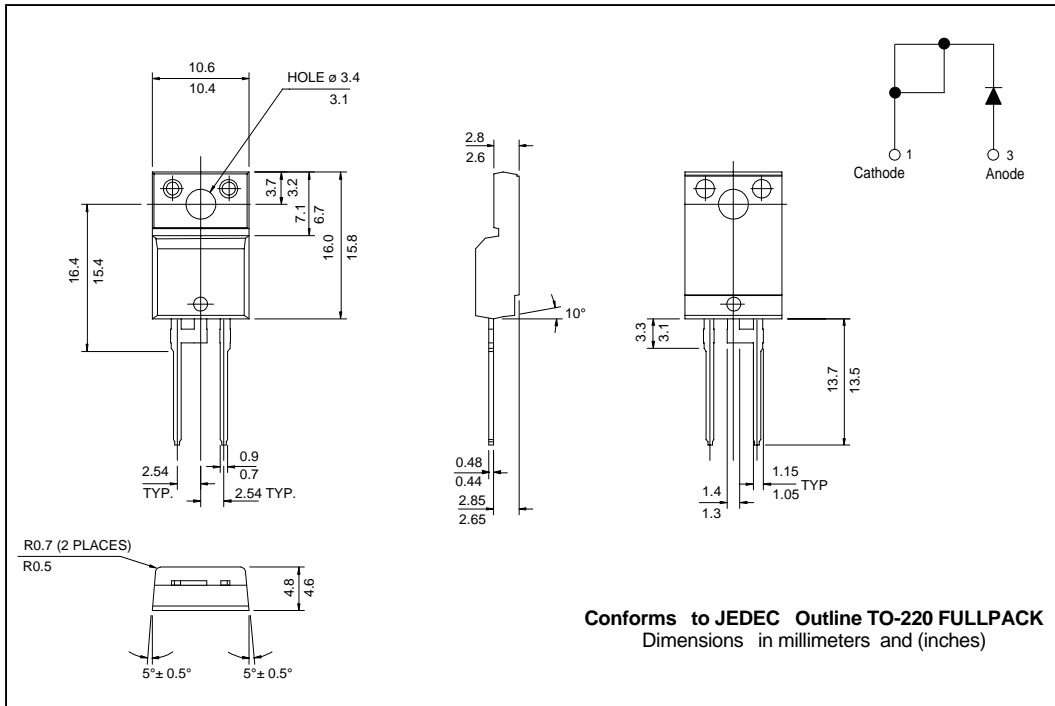

Ordering Information Table

Device Code					
8	E	T	L	06	-1
①	②	③	④	⑤	⑥
1	- Current Rating (8 = 8A)				
2	- E = Single Diode				
3	- T = TO-220, D ² Pak				
4	- L = Ultra-low V _F HyperFast Recovery				
5	- Voltage Rating (06 = 600V)				
6	- "-1" = TO-262 Option				
	S = D ² Pak				
	None = TO-220AC				
	FP = TO-220 FULLPACK				

Data and specifications subject to change without notice.
This product has been designed and qualified for Industrial Level.
Qualification Standards can be found on IR's Web site.

International
IOR Rectifier

IR WORLD HEADQUARTERS: 233 Kansas St., El Segundo, California 90245, USA Tel: (310) 252-7105
TAC Fax: (310) 252-7309
Visit us at www.irf.com for sales contact information. 12/02