

**SMALL SIGNAL SCHOTTKY DIODES**

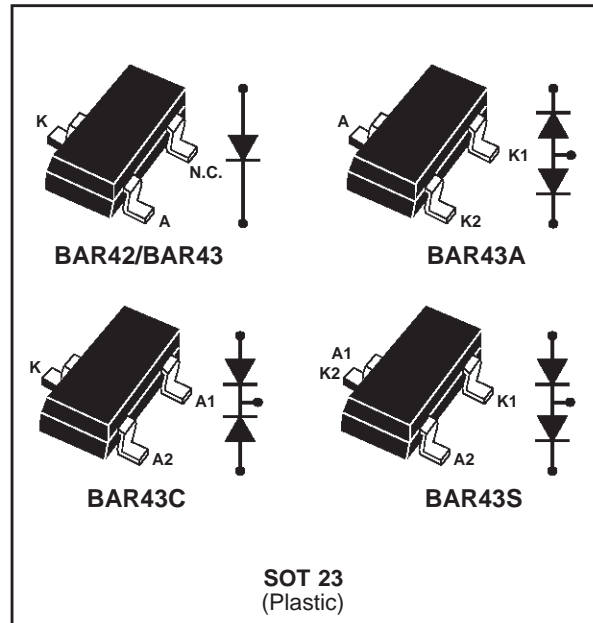

**DESCRIPTION**

General purpose metal to silicon diodes featuring very low turn-on voltage and fast switching.

**ABSOLUTE RATINGS** (limiting values) ( $T_{amb} = 25^{\circ}\text{C}$ ) (see note 1)

Symbol	Parameter	Value	Unit
$V_{RRM}$	Repetitive Peak Reverse Voltage	30	V
$I_F$	Forward Current	100	mA
$I_{FRM}$	Repetitive Peak Forward Current	350	mA
$I_{FSM}$	Surge non Repetitive Forward Current	750	A
$P_{tot}$	Power Dissipation* (see note 2)	160	mW
$T_{stg}$ $T_j$	Storage and Junction Temperature Range	- 55 to + 150 - 55 to + 125	$^{\circ}\text{C}$ $^{\circ}\text{C}$

**THERMAL RESISTANCE** (see note 3)

Symbol	Test Conditions	Value	Unit
$R_{th(j-a)}$	Junction-ambient*	625	$^{\circ}\text{C}/\text{W}$
$R_{th(j-SR)}$	Junction-substrate	400	$^{\circ}\text{C}/\text{W}$

\* Mounted on ceramic substrate: 7 x 5 x 0.5mm.

**Notes:** 1 For double diodes maximum ratings apply to each diode, provided that rated Ptot is not exceeded.

2 For double diodes Ptot is the total power dissipation of the two diodes.

3 For double diodes, Rth refer to the total power dissipation in the two diodes and is given independently of the power distribution in the two diodes.

**ELECTRICAL CHARACTERISTICS**

STATIC CHARACTERISTICS

Symbol	Test Conditions		Min.	Typ.	Max.	Unit	
$V_{BR}$	$T_{amb} = 25^{\circ}C$	$I_R = 100\mu A$	30			V	
$V_F$	$T_{amb} = 25^{\circ}C$	BAR 42	$I_F = 10\text{ mA}$		0.35	0.4	V
			$I_F = 50\text{ mA}$		0.5	0.65	
		BAR 43	$I_F = 2\text{ mA}$	0.26		0.33	
			$I_F = 15\text{ mA}$			0.45	
All	$I_F = 100\text{ mA}$			1			
$I_R$	$T_{amb} = 25^{\circ}C$	$V_R = 25V$			500	nA	
	$T_{amb} = 100^{\circ}C$				100	$\mu A$	

DYNAMIC CHARACTERISTICS

Symbol	Test Conditions			Min.	Typ.	Max.	Unit
C	$T_{amb} = 25^{\circ}C$	$V_R = 1V$	$f = 1MHz$		7		pF
trr	$T_{amb} = 25^{\circ}C$ $I_{rr} = 1mA$	$I_F = 10\text{ mA}$ $R_L = 100\ \Omega$	$I_R = 10\text{ mA}$			5	ns
$\eta^*$	$T_{amb} = 25^{\circ}C$ $F = 45MHz$	$R_L = 50\text{ K}\Omega$ $V_i = 2V$	$C_L = 300\text{ pF}$ for BAR 43	80			%

\* Detection efficiency.

Figure 1. Forward current versus forward voltage at different temperatures (typical values).

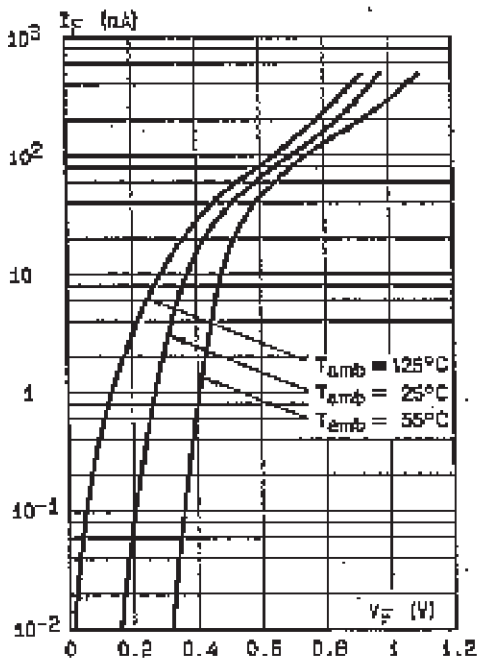

Figure 2. Forward current versus forward voltage (typical values).

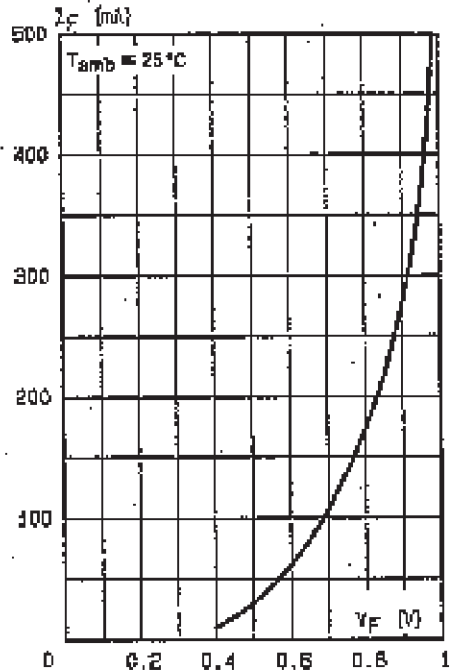

Figure 3. Reverse current versus junction temperature (typical values).

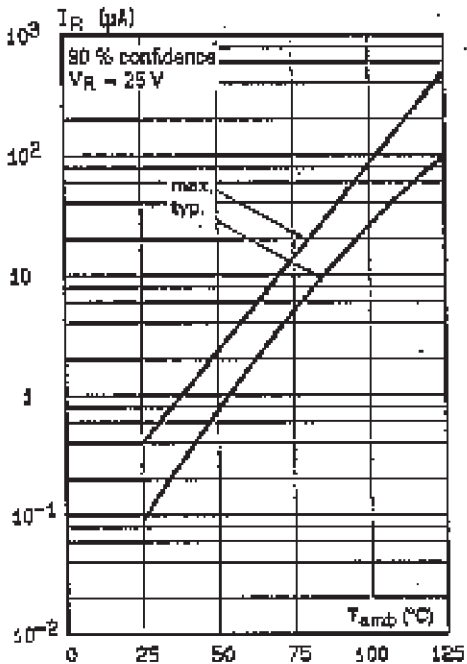

Figure 4. Reverse current versus continuous reverse voltage.

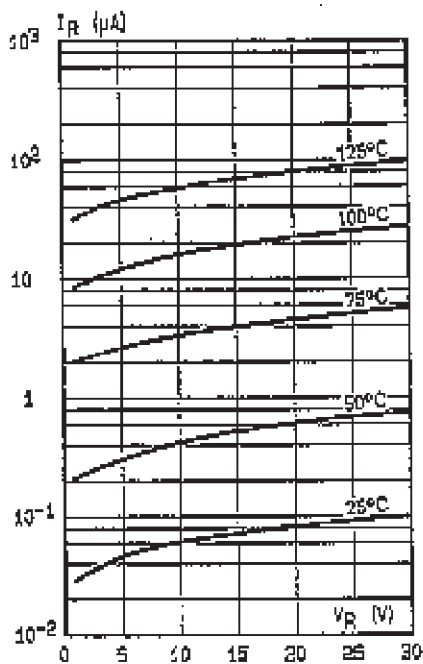
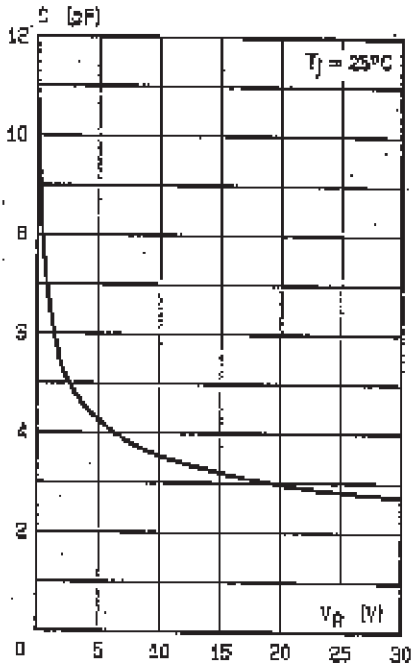

Figure 5. Capacitance C versus reverse applied voltage  $V_R$  (typical values).



# BAR 42/BAR 43, A, C, S

## PACKAGE MECHANICAL DATA

SOT 23 (Plastic)

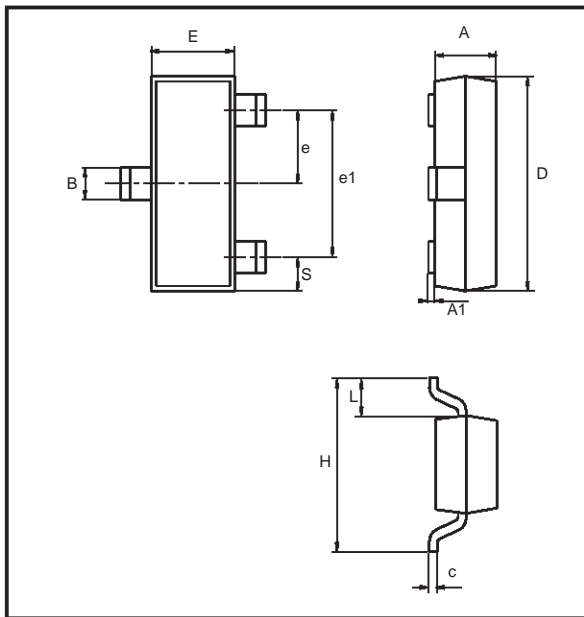

REF.	DIMENSIONS			
	Millimeters		Inches	
	Min.	Max.	Min.	Max.
A	0.64	1.3	0.025	0.051
A1		0.1		0.004
B	0.3	0.54	0.012	0.021
c	0.085	0.18	0.003	0.007
D	2.67	3.05	0.105	0.120
e	0.89	1.05	0.035	0.041
e1	1.7	2.1	0.067	0.083
E	1.2	1.6	0.047	0.063
H	2.1	2.75	0.083	0.108
S	0.35	0.65	0.014	0.026

## FOOT PRINT DIMENSIONS

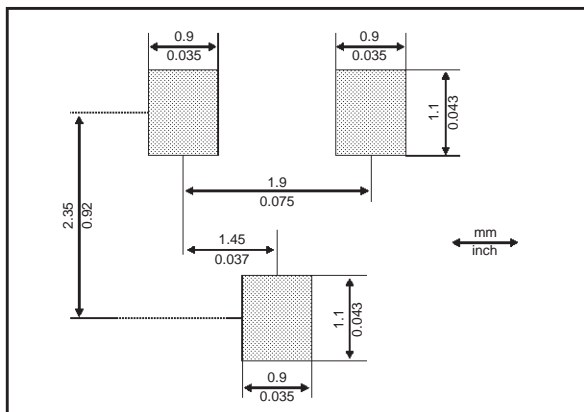

Type	BAR42	BAR43	BAS43A	BAR43C	BAR43S
Marking	D94	D95	DB1	DB2	DA5

Weight : 0.010g

Information furnished is believed to be accurate and reliable. However, SGS-THOMSON Microelectronics assumes no responsibility for the consequences of use of such information nor for any infringement of patents or other rights of third parties which may result from its use. No license is granted by implication or otherwise under any patent or patent rights of SGS-THOMSON Microelectronics. Specifications mentioned in this publication are subject to change without notice. This publication supersedes and replaces all information previously supplied. SGS-THOMSON Microelectronics products are not authorized for use as critical components in life support devices or systems without express written approval of SGS-THOMSON Microelectronics.

© 1998 SGS-THOMSON Microelectronics - Printed in Italy - All rights reserved.

SGS-THOMSON Microelectronics GROUP OF COMPANIES  
 Australia - Brazil - Canada - China - France - Germany - Italy - Japan - Korea - Malaysia - Malta - Morocco  
 The Netherlands - Singapore - Spain - Sweden - Switzerland - Taiwan - Thailand - United Kingdom - U.S.A.