

DATA SHEET

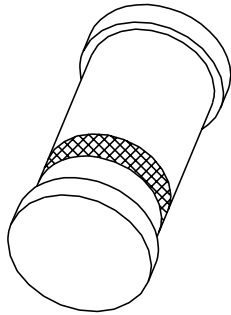

BAV100 to BAV103 General purpose diodes

Product specification
Supersedes data of April 1996

1996 Sep 17

General purpose diodes

BAV100 to BAV103

FEATURES

- Small hermetically sealed glass SMD package
- Switching speed: max. 50 ns
- General application
- Continuous reverse voltage: max. 50 V, 100 V, 150 V and 200 V respectively
- Repetitive peak reverse voltage: max. 60 V, 120 V, 200 V and 250 V respectively
- Repetitive peak forward current: max. 625 mA.

APPLICATIONS

- Switching in industrial equipment e.g. oscilloscopes, digital voltmeters and video output stages in colour television.

DESCRIPTION

The BAV100 to BAV103 are switching diodes fabricated in planar technology, and encapsulated in small hermetically sealed glass SOD80C SMD packages.

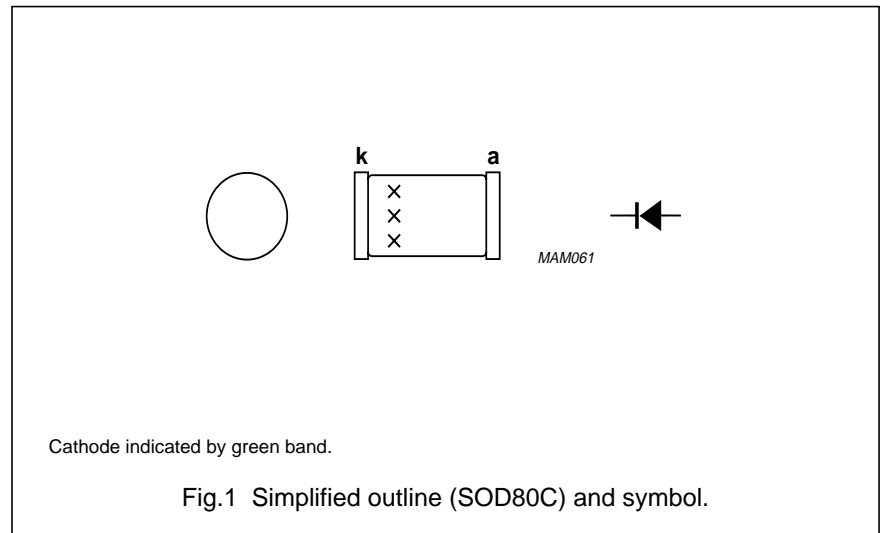

General purpose diodes

BAV100 to BAV103

LIMITING VALUES

In accordance with the Absolute Maximum Rating System (IEC 134).

SYMBOL	PARAMETER	CONDITIONS	MIN.	MAX.	UNIT
V _{RRM}	repetitive peak reverse voltage				
	BAV100		–	60	V
	BAV101		–	120	V
	BAV102		–	200	V
	BAV103		–	250	V
V _R	continuous reverse voltage				
	BAV100		–	50	V
	BAV101		–	100	V
	BAV102		–	150	V
	BAV103		–	200	V
I _F	continuous forward current	see Fig.2; note 1	–	250	mA
I _{FRM}	repetitive peak forward current		–	625	mA
I _{FSM}	non-repetitive peak forward current	square wave; T _j = 25 °C prior to surge; see Fig.4			
		t = 1 μs	–	9	A
		t = 100 μs	–	3	A
		t = 1 s	–	1	A
P _{tot}	total power dissipation	T _{amb} = 25 °C; note 1	–	400	mW
T _{stg}	storage temperature		–65	+175	°C
T _j	junction temperature		–	175	°C

Note

1. Device mounted on an FR4 printed-circuit board.

General purpose diodes

BAV100 to BAV103

ELECTRICAL CHARACTERISTICS

$T_j = 25\text{ °C}$; unless otherwise specified.

SYMBOL	PARAMETER	CONDITIONS	MIN.	MAX.	UNIT
V_F	forward voltage	see Fig.3			
		$I_F = 100\text{ mA}$	–	1.0	V
		$I_F = 200\text{ mA}$	–	1.25	V
I_R	reverse current BAV100	see Fig.5			
		$V_R = 50\text{ V}$	–	100	nA
	$V_R = 50\text{ V}; T_j = 150\text{ °C}$	–	100	μA	
	BAV101	$V_R = 100\text{ V}$	–	100	nA
		$V_R = 100\text{ V}; T_j = 150\text{ °C}$	–	100	μA
	BAV102	$V_R = 150\text{ V}$	–	100	nA
$V_R = 150\text{ V}; T_j = 150\text{ °C}$		–	100	μA	
BAV103	$V_R = 200\text{ V}$	–	100	nA	
	$V_R = 200\text{ V}; T_j = 150\text{ °C}$	–	100	μA	
C_d	diode capacitance	$f = 1\text{ MHz}; V_R = 0$; see Fig.6	–	5	pF
t_{rr}	reverse recovery time	when switched from $I_F = 30\text{ mA}$ to $I_R = 30\text{ mA}; R_L = 100\ \Omega$; measured at $I_R = 3\text{ mA}$; see Fig.8	–	50	ns

THERMAL CHARACTERISTICS

SYMBOL	PARAMETER	CONDITIONS	VALUE	UNIT
$R_{th\ j-tp}$	thermal resistance from junction to tie-point		300	K/W
$R_{th\ j-a}$	thermal resistance from junction to ambient	note 1	375	K/W

Note

1. Device mounted on an FR4 printed-circuit board.

General purpose diodes

BAV100 to BAV103

GRAPHICAL DATA

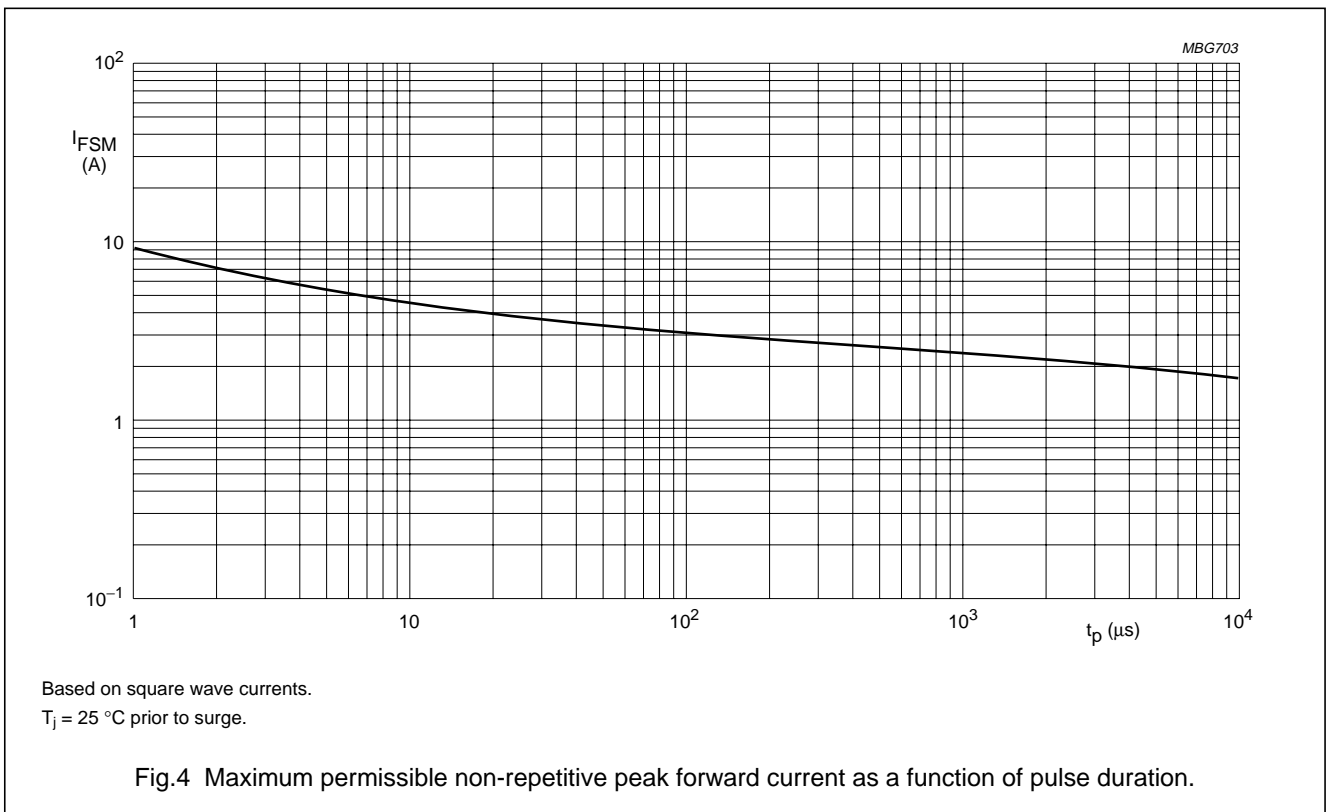
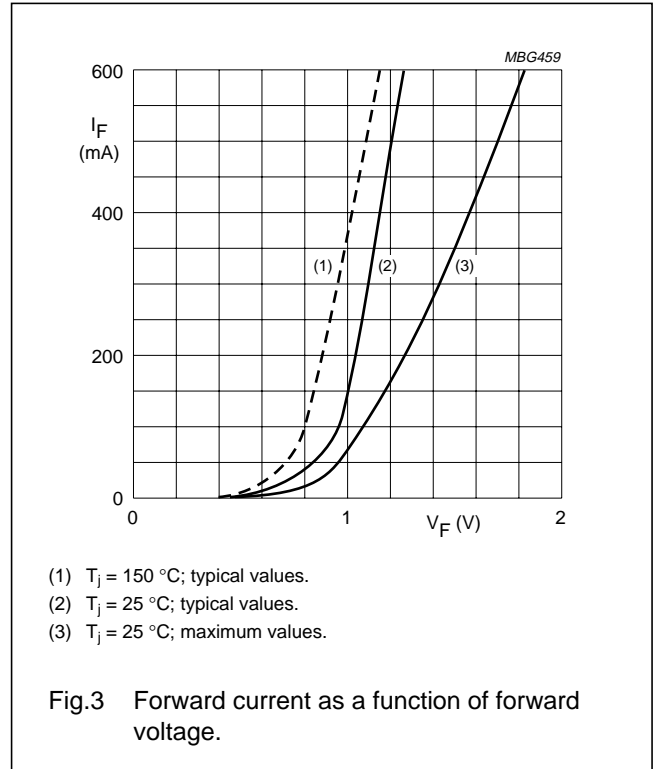
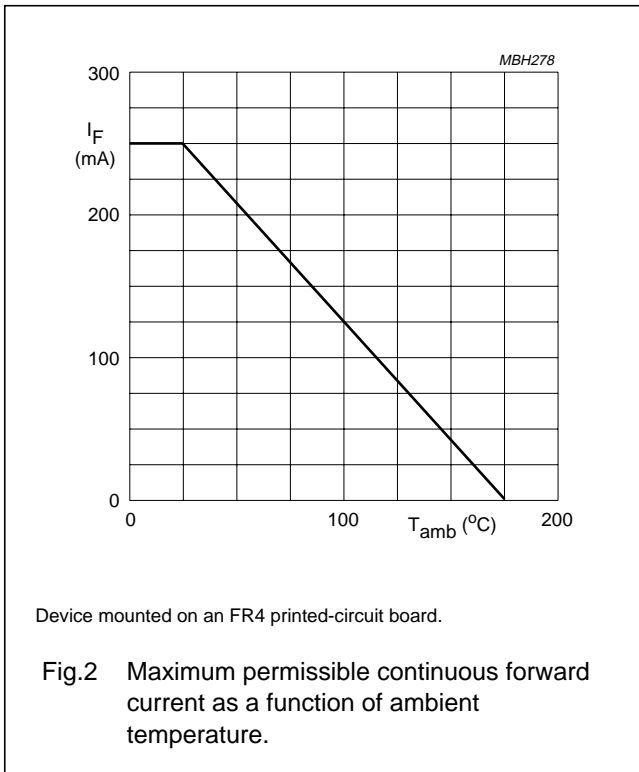

General purpose diodes

BAV100 to BAV103

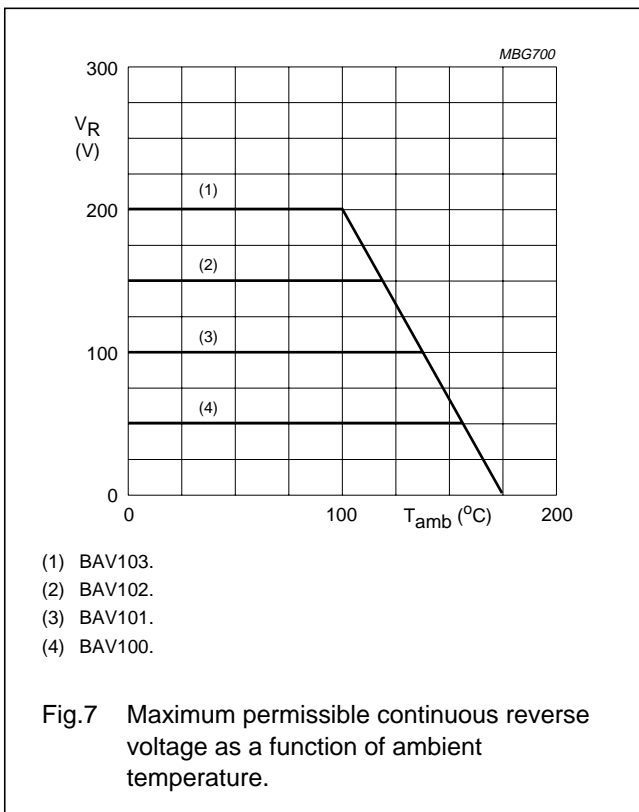
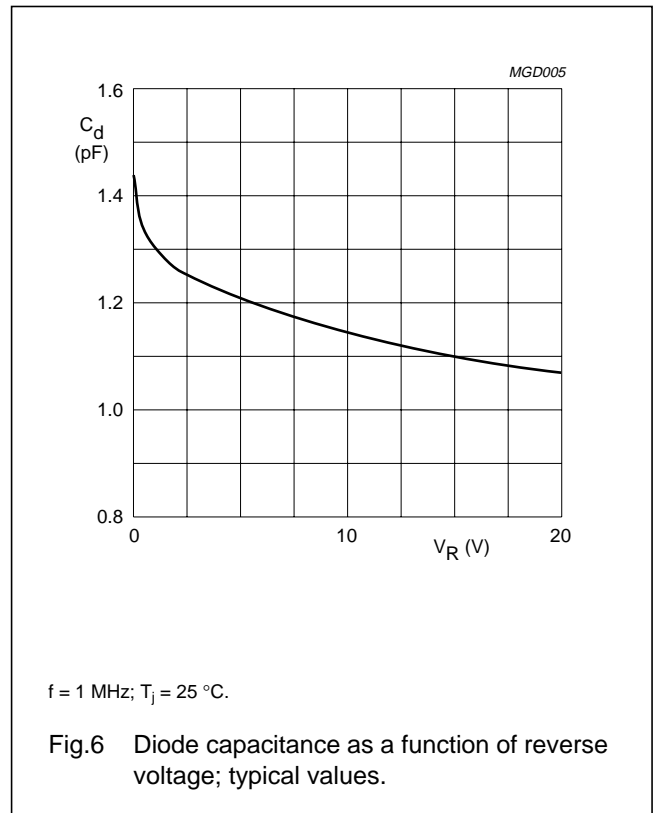
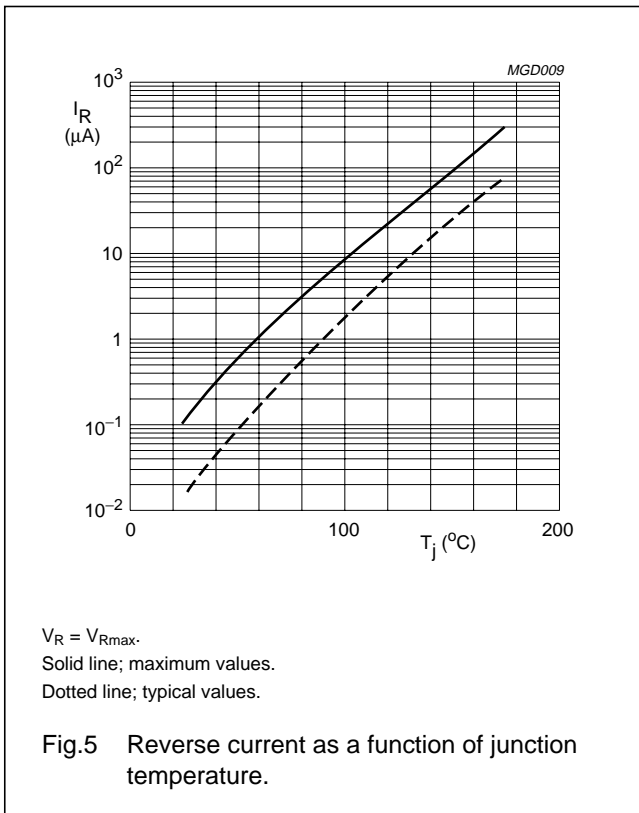

General purpose diodes

BAV100 to BAV103

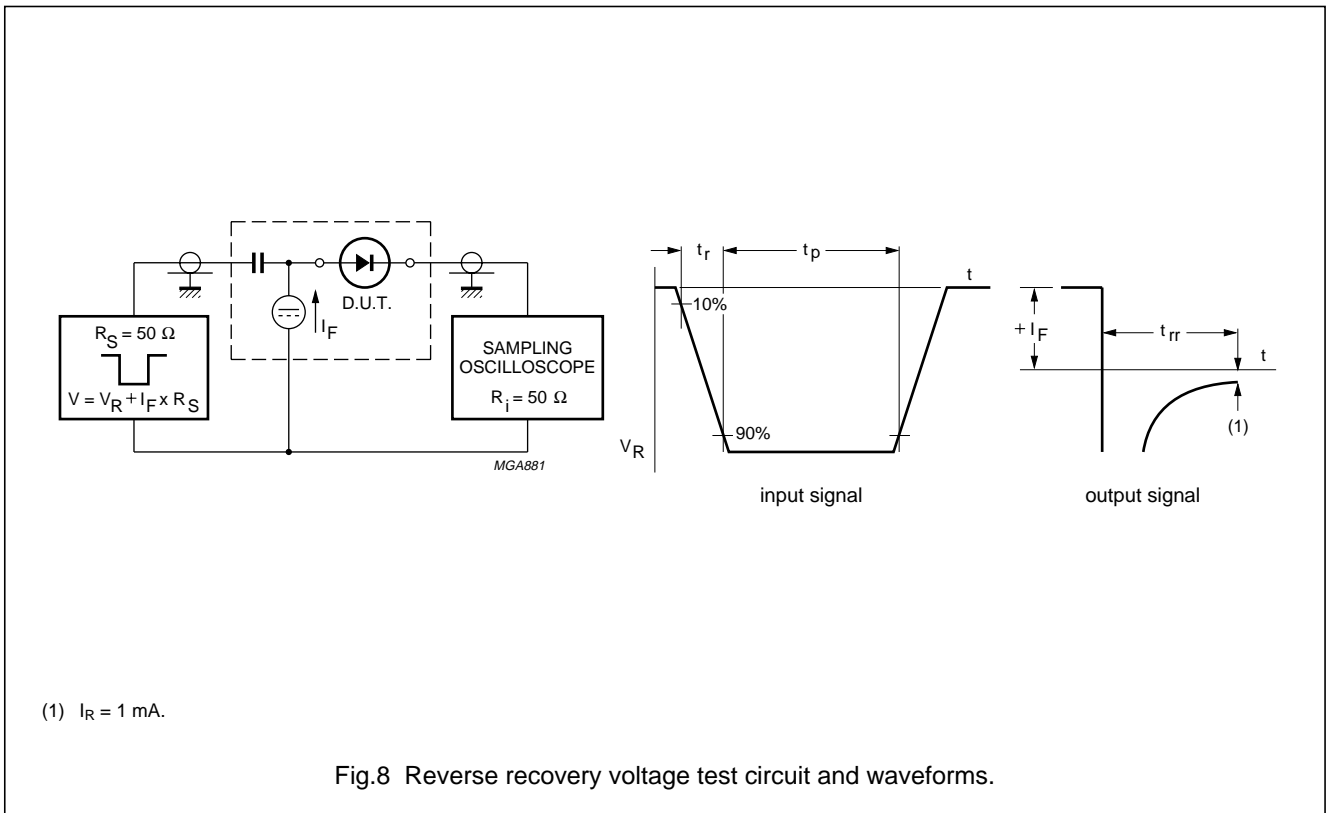
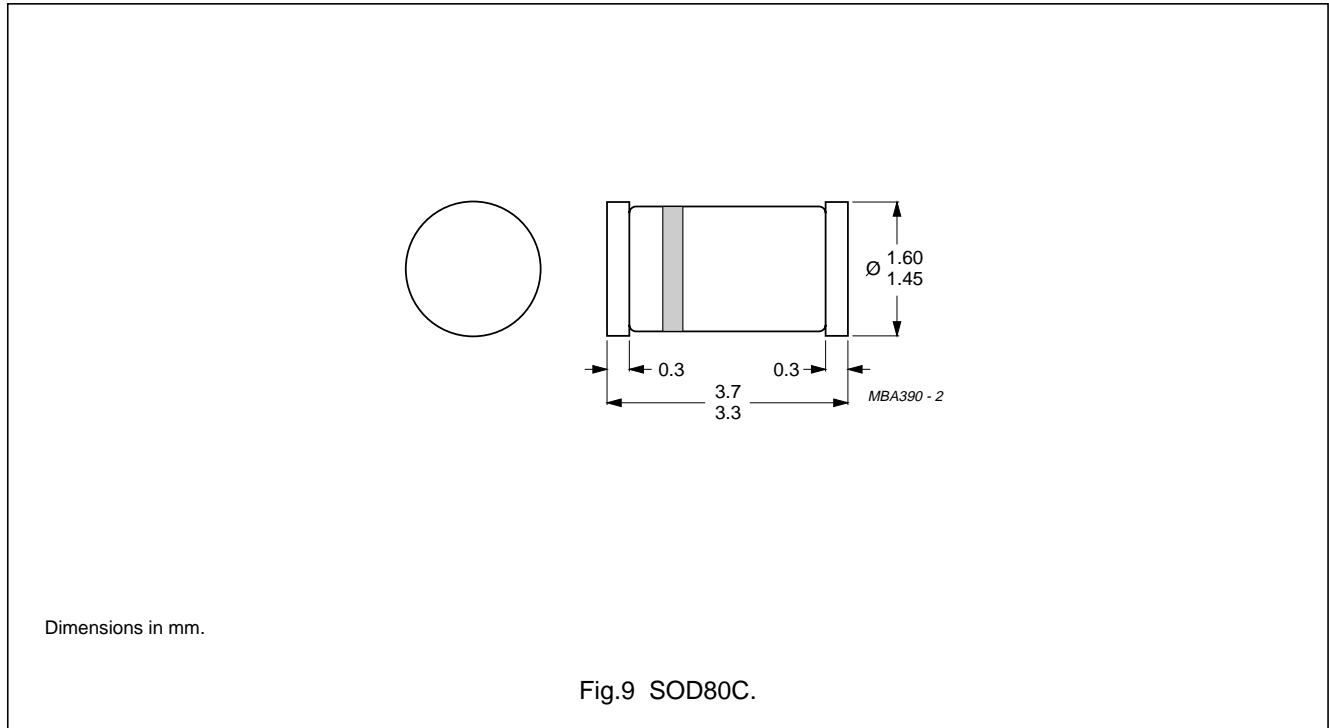

Fig.8 Reverse recovery voltage test circuit and waveforms.

General purpose diodes

BAV100 to BAV103

PACKAGE OUTLINE



DEFINITIONS

Data Sheet Status	
Objective specification	This data sheet contains target or goal specifications for product development.
Preliminary specification	This data sheet contains preliminary data; supplementary data may be published later.
Product specification	This data sheet contains final product specifications.
Limiting values	
Limiting values given are in accordance with the Absolute Maximum Rating System (IEC 134). Stress above one or more of the limiting values may cause permanent damage to the device. These are stress ratings only and operation of the device at these or at any other conditions above those given in the Characteristics sections of the specification is not implied. Exposure to limiting values for extended periods may affect device reliability.	
Application information	
Where application information is given, it is advisory and does not form part of the specification.	

LIFE SUPPORT APPLICATIONS

These products are not designed for use in life support appliances, devices, or systems where malfunction of these products can reasonably be expected to result in personal injury. Philips customers using or selling these products for use in such applications do so at their own risk and agree to fully indemnify Philips for any damages resulting from such improper use or sale.