

NSPM8151, NSPM8181

15 V and 18 V Unidirectional ESD and Surge Protection Device

Features

- Unidirectional High Voltage ESD & Surge Protection Device
- Provides ESD Protection to IEC61000-4-2 Level 4: ± 30 kV Contact Discharge
- IEC 61000-4-5 (lighting)
- High Voltage Zener Diode Protects Supply Rail up to 100 A (8/20 μ s)
- These Devices are Pb-Free and are RoHS Compliant

APPLICATION DIAGRAM

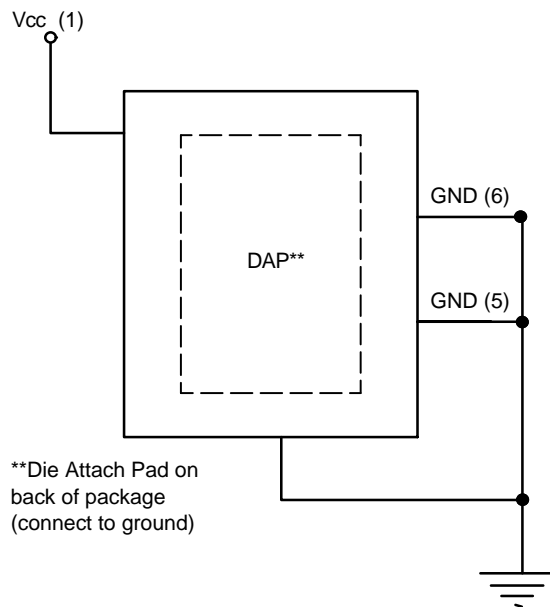

ON Semiconductor®

www.onsemi.com



UDFN6
D4 SUFFIX
CASE 517CS

BLOCK DIAGRAM

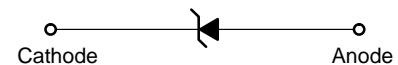

MARKING DIAGRAM



Ax = Specific Device Code
x = 5 or E
M = Date Code
▪ = Pb-Free Package

ORDERING INFORMATION

Device	Package	Shipping†
NSPM8151MUTBG	UDFN6 (Pb-Free)	3000 / Tape & Reel
NSPM8181MUTBG	UDFN6 (Pb-Free)	3000 / Tape & Reel

†For information on tape and reel specifications, including part orientation and tape sizes, please refer to our Tape and Reel Packaging Specification Brochure, BRD8011/D.

NSPM8151, NSPM8181

Table 1. PIN DESCRIPTIONS

4-Channel, 6-Lead, UDFN-8 Package			
Pin	Name	Type	Description
1	V _{CC}	HV V _{DD}	HV ESD Channel
2	N/C		No Connect
3	N/C		No Connect
4	N/C		No Connect
5	GND		Ground
6	GND		Ground

PACKAGE / PINOUT DIAGRAMS

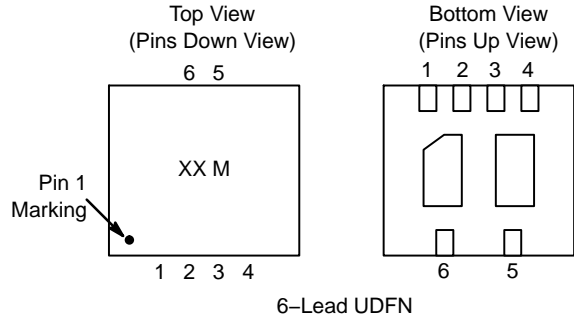

ELECTRICAL CHARACTERISTICS

Symbol	Parameter
I _{PP}	Maximum Reverse Peak Pulse Current
V _C	Clamping Voltage @ I _{PP}
V _{RWM}	Working Peak Reverse Voltage
I _R	Maximum Reverse Leakage Current @ V _{RWM}
V _{BR}	Breakdown Voltage @ I _T
I _T	Test Current
∅V _{BR}	Maximum Temperature Coefficient of V _{BR}
I _F	Forward Current
V _F	Forward Voltage @ I _F

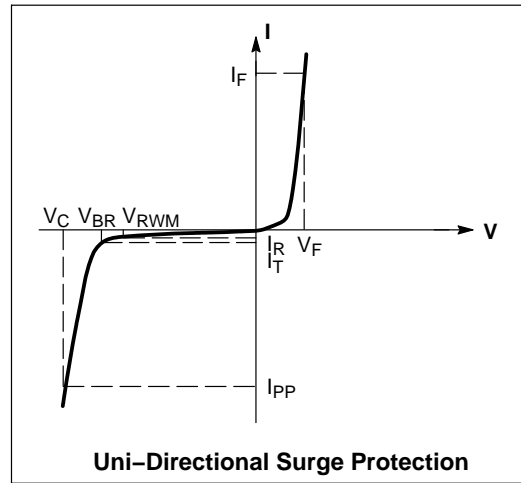

SPECIFICATIONS

Table 2. ABSOLUTE MAXIMUM RATINGS

Parameter	Rating	Units
Operating Temperature Range	-55 to +125	°C
Storage Temperature Range	-65 to +150	°C
Peak Current (t _p = 8/20 μs)	NSPM8151: 100 NSPM8181: 119	A

Stresses exceeding those listed in the Maximum Ratings table may damage the device. If any of these limits are exceeded, device functionality should not be assumed, damage may occur and reliability may be affected.

ELECTRICAL CHARACTERISTICS

Device Name	Device Marking	V _{RWM} (V) (Note 1) Max	I _R @ V _{RWM} (μA) Max	Breakdown Voltage				V _C @ I _{PP} (8 x 20 μs) (Note 3)	
				V _{BR} V (Note 2)			@ I _T (mA)	V _C (V)	I _{PP} (A)
				Min	Nom	Max		Max	
NSPM8151	A5	15	1	16	17.5	18.5	1	27	100
NSPM8181	A8	18	1	20	22.5	23.5	1	28 30	70 100

Product parametric performance is indicated in the Electrical Characteristics for the listed test conditions, unless otherwise noted. Product performance may not be indicated by the Electrical Characteristics if operated under different conditions.

1. A surge protector is normally selected according to the working peak reverse voltage (V_{RWM}), which should be equal to or greater than the DC or continuous peak operating voltage level.
2. V_{BR} measured at pulse test current I_T at an ambient temperature of 25°C.
3. Surge current waveform per Figure 1.

NSPM8151, NSPM8181

TYPICAL CHARACTERISTICS

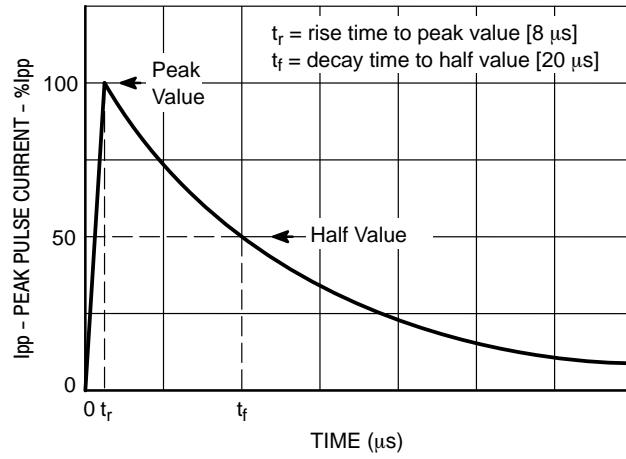
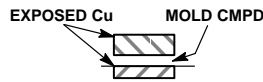
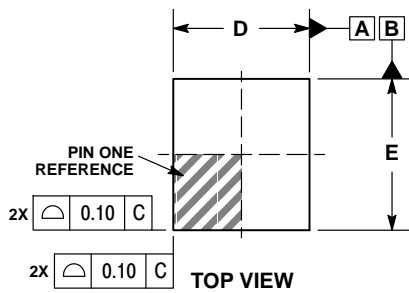

Figure 1. IEC61000-4-5 8/20 μ s Pulse Waveform

NSPM8151, NSPM8181

PACKAGE DIMENSIONS

UDFN6, 1.8x2, 0.4P CASE 517CS ISSUE O



DETAIL B
ALTERNATE
CONSTRUCTION

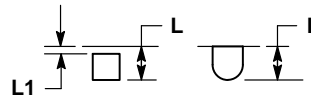

DETAIL A
ALTERNATE
CONSTRUCTIONS

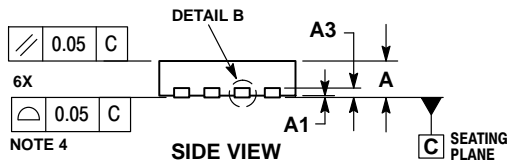

SIDE VIEW

NOTES:

1. DIMENSIONING AND TOLERANCING PER ASME Y14.5M, 1994.
2. CONTROLLING DIMENSION: MILLIMETERS.
3. DIMENSION b APPLIES TO PLATED TERMINALS AND IS MEASURED BETWEEN 0.15 AND 0.30mm FROM THE TERMINAL TIP.
4. COPLANARITY APPLIES TO THE EXPOSED PAD AS WELL AS THE TERMINALS.

DIM	MILLIMETERS	
	MIN	MAX
A	0.45	0.55
A1	0.00	0.05
A3	0.125 REF	
b	0.15	0.25
D	1.80 BSC	
D2	0.35	0.55
E	2.00 BSC	
E2	0.74	0.94
e	0.40 BSC	
e1	0.80 BSC	
e2	0.95 BSC	
L	0.20	0.40
L1	---	0.15

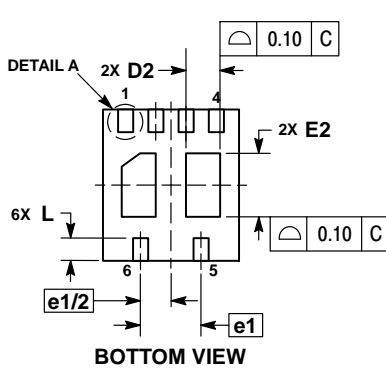

BOTTOM VIEW

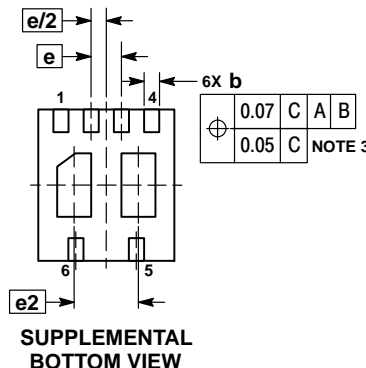

SUPPLEMENTAL
BOTTOM VIEW

RECOMMENDED MOUNTING FOOTPRINT*

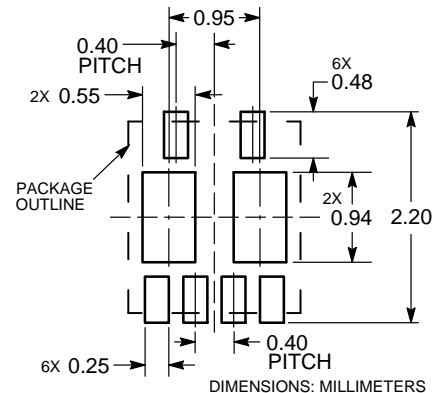

*For additional information on our Pb-Free strategy and soldering details, please download the ON Semiconductor Soldering and Mounting Techniques Reference Manual, SOLDERRM/D.

ON Semiconductor and are trademarks of Semiconductor Components Industries, LLC dba ON Semiconductor or its subsidiaries in the United States and/or other countries. ON Semiconductor owns the rights to a number of patents, trademarks, copyrights, trade secrets, and other intellectual property. A listing of ON Semiconductor's product/patent coverage may be accessed at www.onsemi.com/site/pdf/Patent-Marking.pdf. ON Semiconductor reserves the right to make changes without further notice to any products herein. ON Semiconductor makes no warranty, representation or guarantee regarding the suitability of its products for any particular purpose, nor does ON Semiconductor assume any liability arising out of the application or use of any product or circuit, and specifically disclaims any and all liability, including without limitation special, consequential or incidental damages. Buyer is responsible for its products and applications using ON Semiconductor products, including compliance with all laws, regulations and safety requirements or standards, regardless of any support or applications information provided by ON Semiconductor. "Typical" parameters which may be provided in ON Semiconductor data sheets and/or specifications can and do vary in different applications and actual performance may vary over time. All operating parameters, including "Typicals" must be validated for each customer application by customer's technical experts. ON Semiconductor does not convey any license under its patent rights nor the rights of others. ON Semiconductor products are not designed, intended, or authorized for use as a critical component in life support systems or any FDA Class 3 medical devices or medical devices with a same or similar classification in a foreign jurisdiction or any devices intended for implantation in the human body. Should Buyer purchase or use ON Semiconductor products for any such unintended or unauthorized application, Buyer shall indemnify and hold ON Semiconductor and its officers, employees, subsidiaries, affiliates, and distributors harmless against all claims, costs, damages, and expenses, and reasonable attorney fees arising out of, directly or indirectly, any claim of personal injury or death associated with such unintended or unauthorized use, even if such claim alleges that ON Semiconductor was negligent regarding the design or manufacture of the part. ON Semiconductor is an Equal Opportunity/Affirmative Action Employer. This literature is subject to all applicable copyright laws and is not for resale in any manner.

PUBLICATION ORDERING INFORMATION

LITERATURE FULFILLMENT:
Literature Distribution Center for ON Semiconductor
19521 E. 32nd Pkwy, Aurora, Colorado 80011 USA
Phone: 303-675-2175 or 800-344-3860 Toll Free USA/Canada
Fax: 303-675-2176 or 800-344-3867 Toll Free USA/Canada
Email: orderlit@onsemi.com

N. American Technical Support: 800-282-9855 Toll Free
USA/Canada
Europe, Middle East and Africa Technical Support:
Phone: 421 33 790 2910
Japan Customer Focus Center
Phone: 81-3-5817-1050

ON Semiconductor Website: www.onsemi.com
Order Literature: <http://www.onsemi.com/orderlit>
For additional information, please contact your local Sales Representative