



**UNI-AND BIDIRECTIONAL TRANSIENT VOLTAGE SUPPRESSORS**

- HIGH SURGE CAPABILITY :  
1.5 kW / 1 ms EXPO
- VERY FAST CLAMPING TIME :  
1 ps FOR UNIDIRECTIONAL TYPES  
5 ns FOR BIDIRECTIONAL TYPES
- LARGE VOLTAGE RANGE :  
5.5 V → 188 V
- ORDER CODE :  
TYPE NUMBER FOR UNIDIRECTIONAL TYPES, TYPE NUMBER + SUFFIX C FOR BIDIRECTIONAL TYPES



**SURFACE MOUNT TRANSIL FEATURES**

- A PERFECT PICK AND PLACE BEHAVIOUR
- AN EXCELLENT ON BOARD STABILITY
- A FULL COMPATIBILITY WITH BOTH GLUING AND PASTE SOLDERING TECHNOLOGIES
- BODY MARKED WITH TYPE CODE AND LOGO
- STANDARD PACKAGING : 12 mm TAPE (EIA STD. RS481)
- TINNED COPPER LEADS
- HIGH TEMPERATURE RESISTANT RESIN

**DESCRIPTION**

Transient voltage suppressor diodes especially useful in protecting integrated circuits, MOS, hybrids and other voltage-sensitive semiconductors and components.

**ABSOLUTE RATINGS (limiting values)**

| Symbol             | Parameter  | Value                               | Unit                    |
|--------------------|--|-------------------------------------|-------------------------|
| $P_p$              | Peak Pulse Power for 1 ms Exponential Pulse                        | $T_j$ Initial = 25 °C<br>See note 1 | 1500<br>W               |
| P                  | Power Dissipation on Infinite Heatsink                             | $T_{amb}$ = 25 °C                   | 1.7<br>W                |
| $I_{FSM}$          | Non Repetitive Surge Peak Forward Current for Unidirectional Types | $T_j$ Initial = 25 °C<br>t = 10 ms  | 150<br>A                |
| $T_{stg}$<br>$T_j$ | Storage and Operating Junction Temperature Range                   |                                     | - 65 to 175<br>°C<br>°C |
| $T_L$              | Maximum Lead Temperature for Soldering During 10 s                 |                                     | 260<br>°C               |

**THERMAL RESISTANCE**

| Symbol        | Parameter      | Value | Unit |
|---------------|----------------|-------|------|
| $R_{th(j-l)}$ | Junction-leads | 10    | °C/W |

Note : 1. For surges upper than the maximum values, the diode will present a short-circuit anode-cathode.

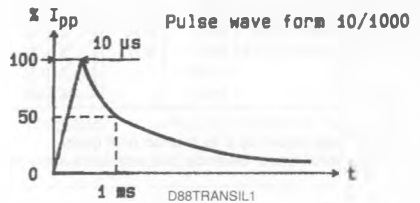

ELECTRICAL CHARACTERISTICS (T<sub>J</sub> = 25 °C)

| Symbol                | Parameter                                    | Value                |           |
|-----------------------|--|----------------------|-----------|
| V <sub>RM</sub>       | Stand-off Voltage                            | See tables           |           |
| V <sub>(BR)</sub>     | Breakdown Voltage                            |                      |           |
| V <sub>(CL)</sub>     | Clamping Voltage                             |                      |           |
| I <sub>pp</sub>       | Peak Pulse Current                           |                      |           |
| α <sub>T</sub>        | Temperature Coefficient of V <sub>(BR)</sub> |                      |           |
| C                     | Capacitance                                  |                      |           |
| t <sub>clamping</sub> | Clamping Time (0 volt to V <sub>(BR)</sub> ) | Unidirectional Types | 1 ps max. |
|                       |  | Bidirectional Types  | 5 ns max. |

| Types          |               | Marking        |               | I <sub>RM</sub> @ V <sub>RM</sub> max. |      | V <sub>(BR)</sub> * @ I <sub>R</sub> |      |      | V <sub>(CL)</sub> @ I <sub>pp</sub> max. |      | V <sub>(CL)</sub> @ I <sub>pp</sub> max. |      | α <sub>T</sub> max. | C** typ. V <sub>A</sub> =0 f=1MHz |      |
|----------------|---------------|----------------|---------------|--|------|--------------------------------------|------|------|--|------|--|------|---------------------|-----------------------------------|------|
| Unidirectional | Bidirectional | Unidirectional | Bidirectional | (μA)                                   | (V)  | min.                                 | nom. | max. | (mA)                                     | (V)  | (A)                                      | (V)  | (A)                 | (10 <sup>-4</sup> /°C)            | (pF) |
|                |               |                |               |  |      |                                      |      |      | 1ms expo                                 |      | 8-20μs expo                              |      |                     |                                   |      |
| SM15T6V8       | SM15T6V8C     | MDD            | BDD           | 1000                                   | 5.5  | 6.12                                 | 6.8  | 7.48 | 10                                       | 10.8 | 139                                      | 14   | 714                 | 5.7                               | 9500 |
| SM15T6V8A      | SM15T6V8CA    | MDE            | BDE           | 1000                                   | 5.8  | 6.45                                 | 6.8  | 7.14 | 10                                       | 10.5 | 143                                      | 13.4 | 746                 | 5.7                               | 9500 |
| SM15T7V5       | SM15T7V5C     | MDF            | BDF           | 1000                                   | 6.05 | 6.75                                 | 7.5  | 8.25 | 10                                       | 11.7 | 128                                      | 15.2 | 660                 | 6.1                               | 8500 |
| SM15T7V5A      | SM15T7V5CA    | MDF            | BDF           | 1000                                   | 6.4  | 7.13                                 | 7.5  | 7.88 | 10                                       | 11.3 | 132                                      | 14.5 | 690                 | 6.1                               | 8500 |
| SM15T10        | SM15T10C      | MDN            | BDN           | 10                                     | 8.1  | 9.0                                  | 10   | 11   | 1  | 15   | 100                                      | 19.5 | 928                 | 7.3                               | 7000 |
| SM15T10A       | SM15T10CA     | MDP            | BDP           | 10                                     | 8.55 | 9.5                                  | 10   | 10.5 | 1  | 14.5 | 103                                      | 18.6 | 968                 | 7.3                               | 7000 |
| SM15T12        | SM15T12C      | MDS            | BDS           | 5                                      | 9.72 | 10.8                                 | 12   | 13.2 | 1  | 17.3 | 87                                       | 22.7 | 793                 | 7.8                               | 6000 |
| SM15T12A       | SM15T12CA     | MDT            | BDT           | 5                                      | 10.2 | 11.4                                 | 12   | 12.6 | 1  | 16.7 | 90                                       | 21.7 | 829                 | 7.8                               | 6000 |
| SM15T15        | SM15T15C      | MDW            | BDW           | 5                                      | 12.1 | 13.5                                 | 15   | 16.5 | 1  | 22   | 68                                       | 28.4 | 634                 | 8.4                               | 5000 |
| SM15T15A       | SM15T15CA     | MDX            | BDX           | 5                                      | 12.8 | 14.3                                 | 15   | 15.8 | 1  | 21.2 | 71                                       | 27.2 | 662                 | 8.4                               | 5000 |
| SM15T18        | SM15T18C      | MED            | BED           | 5                                      | 14.5 | 16.2                                 | 18   | 19.8 | 1  | 26.5 | 56.5                                     | 34   | 529                 | 8.8                               | 4300 |
| SM15T18A       | SM15T18CA     | MEE            | BEE           | 5                                      | 15.3 | 17.1                                 | 18   | 18.9 | 1  | 25.2 | 59.5                                     | 32.5 | 554                 | 8.8                               | 4300 |
| SM15T22        | SM15T22C      | MEH            | BEH           | 5                                      | 17.8 | 19.8                                 | 22   | 24.2 | 1  | 31.9 | 47                                       | 41.2 | 437                 | 9.2                               | 3700 |
| SM15T22A       | SM15T22CA     | MEK            | BEK           | 5                                      | 18.8 | 20.9                                 | 22   | 23.1 | 1  | 30.6 | 49                                       | 39.3 | 458                 | 9.2                               | 3700 |
| SM15T24        | SM15T24C      | MEL            | BEL           | 5                                      | 19.4 | 21.6                                 | 24   | 26.4 | 1  | 34.7 | 43                                       | 44.9 | 401                 | 9.4                               | 3500 |
| SM15T24A       | SM15T24CA     | MEM            | BEM           | 5                                      | 20.5 | 22.8                                 | 24   | 25.2 | 1  | 33.2 | 45                                       | 42.8 | 421                 | 9.4                               | 3500 |
| SM15T27        | SM15T27C      | MEN            | BEN           | 5                                      | 21.8 | 24.3                                 | 27   | 29.7 | 1  | 39.1 | 38.5                                     | 50.5 | 356                 | 9.6                               | 3200 |
| SM15T27A       | SM15T27CA     | MEP            | BEP           | 5                                      | 23.1 | 25.7                                 | 27   | 28.4 | 1  | 37.5 | 40                                       | 48.3 | 373                 | 9.6                               | 3200 |
| SM15T30        | SM15T30C      | MEQ            | BEQ           | 5                                      | 24.3 | 27                                   | 30   | 33   | 1  | 43.5 | 34.5                                     | 56.1 | 321                 | 9.7                               | 2900 |
| SM15T30A       | SM15T30CA     | MER            | BER           | 5                                      | 25.6 | 28.5                                 | 30   | 31.5 | 1  | 41.4 | 36                                       | 53.5 | 336                 | 9.7                               | 2900 |
| SM15T33        | SM15T33C      | MES            | BES           | 5                                      | 26.8 | 29.7                                 | 33   | 36.3 | 1  | 47.7 | 31.5                                     | 61.5 | 292                 | 9.8                               | 2700 |
| SM15T33A       | SM15T33CA     | MET            | BET           | 5                                      | 28.2 | 31.4                                 | 33   | 34.7 | 1  | 45.7 | 33                                       | 59   | 305                 | 9.8                               | 2700 |
| SM15T36        | SM15T36C      | MEU            | BEU           | 5                                      | 29.1 | 32.4                                 | 36   | 39.6 | 1  | 52   | 29                                       | 67.3 | 267                 | 9.9                               | 2500 |
| SM15T36A       | SM15T36CA     | MEV            | BEV           | 5                                      | 30.8 | 34.2                                 | 36   | 37.8 | 1  | 49.9 | 30                                       | 64.3 | 280                 | 9.9                               | 2500 |
| SM15T39        | SM15T39C      | MEW            | BEW           | 5                                      | 31.6 | 35.1                                 | 39   | 42.9 | 1  | 56.4 | 26.5                                     | 73   | 246                 | 10.0                              | 2400 |
| SM15T39A       | SM15T39CA     | MEX            | BEX           | 5                                      | 33.3 | 37.1                                 | 39   | 41   | 1  | 53.9 | 28                                       | 69.7 | 258                 | 10.0                              | 2400 |
| SM15T68        | SM15T68C      | MFN            | BFN           | 5                                      | 55.1 | 61.2                                 | 68   | 74.8 | 1  | 98   | 15.3                                     | 127  | 142                 | 10.4                              | 1550 |
| SM15T68A       | SM15T68CA     | MFP            | BFP           | 5                                      | 58.1 | 64.6                                 | 68   | 71.4 | 1  | 92   | 16.3                                     | 121  | 148                 | 10.4                              | 1550 |
| SM15T100       | SM15T100C     | MFV            | BFV           | 5                                      | 81   | 90                                   | 100  | 110  | 1  | 144  | 10.4                                     | 187  | 96                  | 10.6                              | 1150 |
| SM15T100A      | SM15T100CA    | MFX            | BFX           | 5                                      | 85.5 | 95                                   | 100  | 105  | 1  | 137  | 11                                       | 178  | 101                 | 10.6                              | 1150 |
| SM15T150       | SM15T150C     | MGH            | BGH           | 5                                      | 121  | 135                                  | 150  | 165  | 1  | 215  | 7  | 277  | 65                  | 10.8                              | 850  |
| SM15T150A      | SM15T150CA    | MGK            | BGK           | 5                                      | 128  | 143                                  | 150  | 158  | 1  | 207  | 7.2                                      | 265  | 68                  | 10.8                              | 850  |
| SM15T200       | SM15T200C     | MGU            | BGU           | 5                                      | 162  | 180                                  | 200  | 220  | 1  | 287  | 5.2                                      | 370  | 48.5                | 10.8                              | 675  |
| SM15T200A      | SM15T200CA    | MGV            | BGV           | 5                                      | 171  | 190                                  | 200  | 210  | 1  | 274  | 5.5                                      | 353  | 51                  | 10.8                              | 675  |
| SM15T220       |               | MGW            |               | 5                                      | 175  | 198                                  | 220  | 242  | 1  | 344  | 4.3                                      | 406  | 44.5                | 10.8                              | 625  |
| SM15T220A      |               | MGX            |               | 5                                      | 185  | 209                                  | 220  | 231  | 1  | 328  | 4.6                                      | 388  | 46.5                | 10.8                              | 625  |

\*\* Pulse test t<sub>p</sub> < 50 ms δ < 2 %.

\*\* Divide these values by 2 for bidirectional types.

For bidirectional types, electrical characteristics apply in both directions.

ORDER CODE

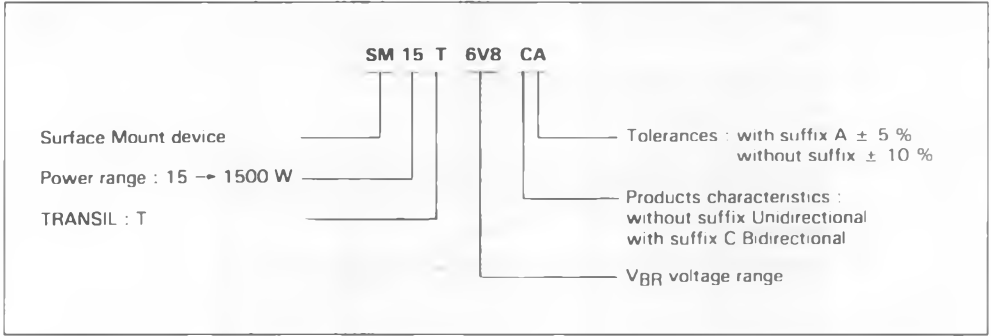

PACKAGE MECHANICAL DATA

SOD 15 Plastic

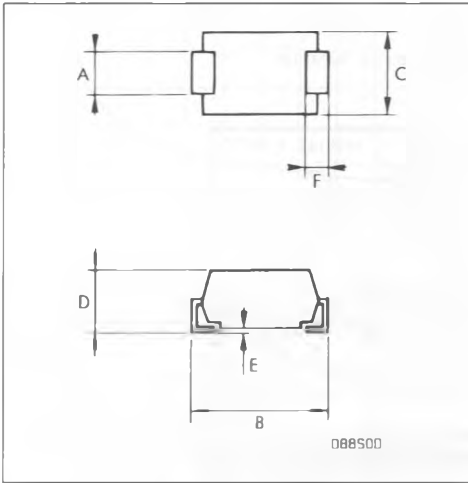

| Ref. | Millimetres |      | Inches |       |
|------|-------------|------|--------|-------|
|      | Min.        | Max. | Min.   | Max.  |
| A    | 2.8         | 3.2  | 0.110  | 0.126 |
| B    | 7.6         | 8.0  | 0.300  | 0.315 |
| C    | 4.8         | 5.2  | 0.190  | 0.200 |
| D    | 2.5         | 3.1  | 0.098  | 0.122 |
| E    | —           | 0.1  | —      | 0.004 |
| F    | 1.3         | 1.7  | 0.051  | 0.067 |

Laser marking.  
The logo indicates cathode for unidirectional types.

FOOT PRINT DIMENSIONS (Millimeters)

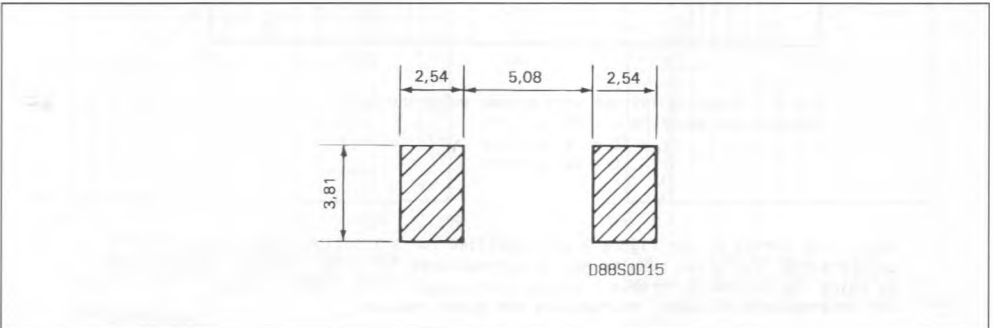

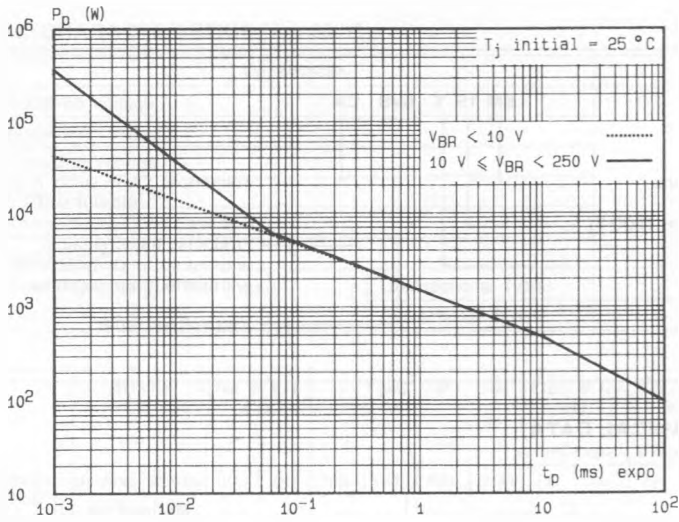

Fig.1 - Peak pulse power versus exponential pulse duration.

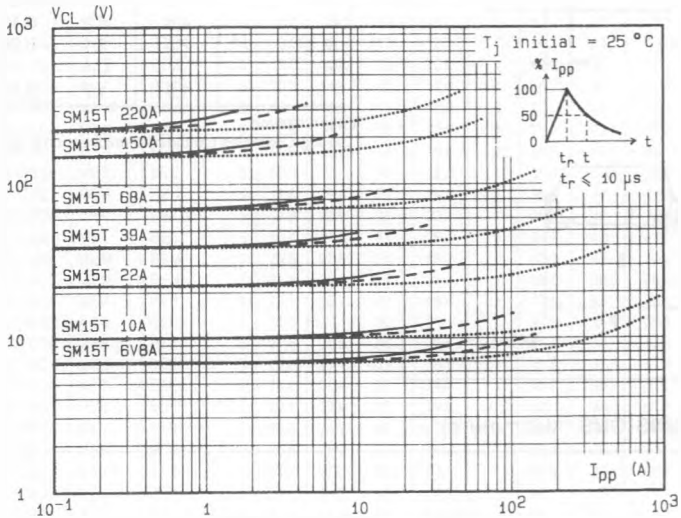

Fig.2 - Clamping voltage versus peak pulse current.  
 exponential waveform  $t = 20 \mu s$  .....  
 $t = 1 ms$  ---  
 $t = 10 ms$  —

Note : The curves of the figure 2 are specified for a junction temperature of 25 °C before surge. The given results may be extrapolated for other junction temperatures by using the following formula :  $\Delta V (BR) = \alpha T (V (BR)) \times [T_j - 25] \times V (BR)$   
 For intermediate voltages, extrapolate the given results.

088SM15TP4

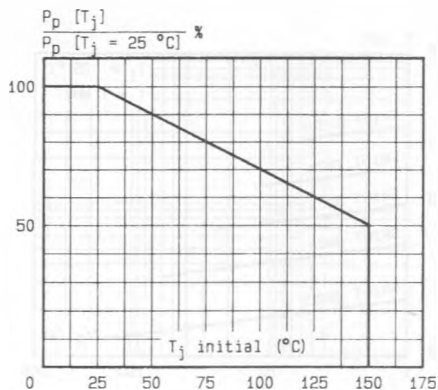

Fig.3 - Allowable power dissipation versus junction temperature.

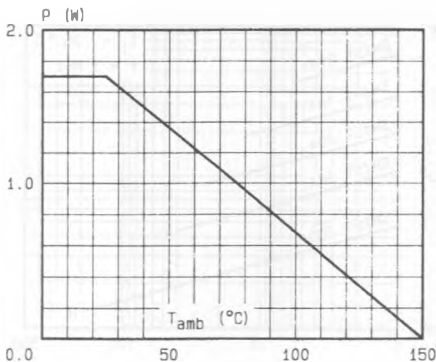

Fig.4 - Power dissipation versus ambient temperature.

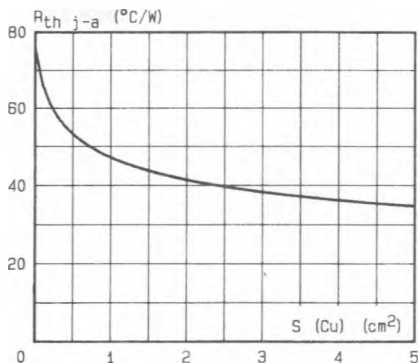

Fig.5 - Thermal resistance junction-ambient versus Cu surface (printed circuit).

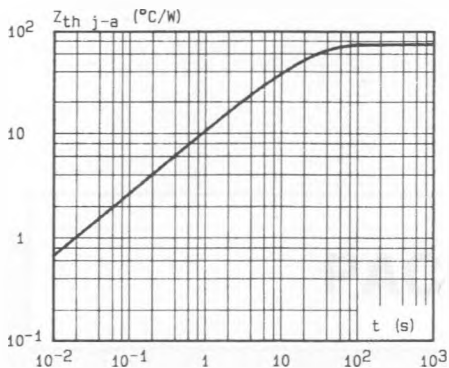

Fig.6 - Transient thermal impedance junction-ambient versus pulse duration.

088SM15TP5

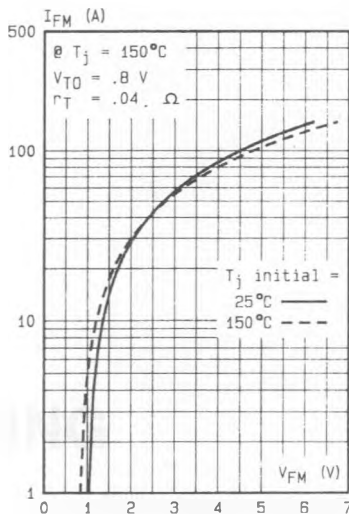

Fig.7 - Peak forward current versus peak forward voltage drop (typical values for unidirectional types).

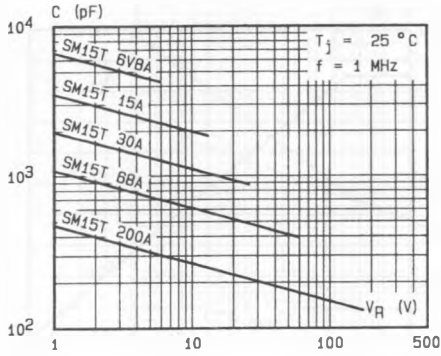

Fig.8a - Capacitance versus reverse applied voltage for unidirectional types (typical values).

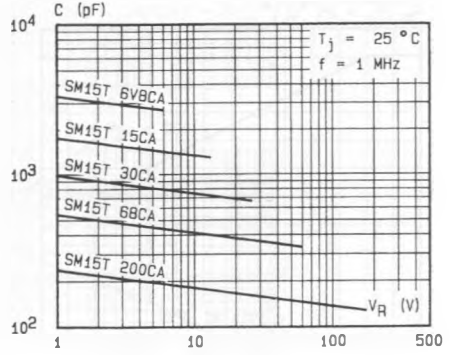

Fig.8b - Capacitance versus reverse applied voltage for bidirectional types (typical values).

DB8SM15TP6