

**UNI-AND BIDIRECTIONAL TRANSIENT
VOLTAGE SUPPRESSORS**

- HIGH SURGE CAPABILITY :
600 W / 1 ms EXPO
- VERY FAST CLAMPING TIME :
1 ps FOR UNIDIRECTIONAL TYPES
5 ns FOR BIDIRECTIONAL TYPES
- LARGE VOLTAGE RANGE :
5.5 V → 188 V
- ORDER CODE :
TYPE NUMBER FOR UNIDIRECTIONAL
TYPES, TYPE NUMBER + SUFFIX C FOR
BIDIRECTIONAL TYPES

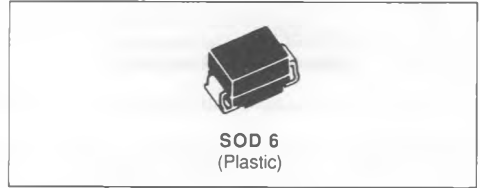

SURFACE MOUNT TRANSIL FEATURES

- A PERFECT PICK AND PLACE BEHAVIOUR
- AN EXCELLENT ON BOARD STABILITY
- A FULL COMPATIBILITY WITH BOTH GLUING
AND PASTE SOLDERING TECHNOLOGIES
- BODY MARKED WITH TYPE CODE AND
LOGO
- STANDARD PACKAGING : 12 mm TAPE
(EIA STD. RS481)
- TINNED COPPER LEADS
- HIGH TEMPERATURE RESISTANT RESIN

DESCRIPTION

Transient voltage suppressor diodes especially useful in protecting integrated circuits, MOS, hybrids and other voltage-sensitive semiconductors and components.

ABSOLUTE RATINGS (limiting values)

Symbol	Parameter	Value	Unit
P_p	Peak Pulse Power for 1 ms Exponential Pulse	T_j Initial = 25 °C See note 1	600 W
P	Power Dissipation on Infinite Heatsink	T_{amb} = 25 °C	1.2 W
I_{FSM}	Non Repetitive Surge Peak Forward Current for Unidirectional Types	T_j Initial = 25 °C t = 10 ms	50 A
T_{stg} T_j	Storage and Operating Junction Temperature Range		- 65 to 175 150 °C °C
T_L	Maximum Lead Temperature for Soldering During 10 s		260 °C

THERMAL RESISTANCE

Symbol	Parameter	Value	Unit
$R_{th(j-l)}$	Junction-leads	20	°C/W

Note : 1. For surges upper than the maximum values, the diode will present a short-circuit anode-cathode.

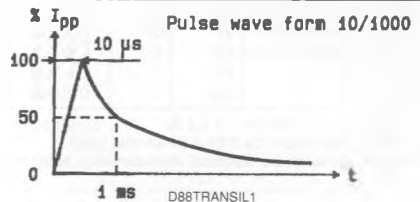

ELECTRICAL CHARACTERISTICS (T_J = 25 °C)

Symbol	Parameter	Value	
V _{RM}	Stand-off Voltage	See tables	
V _(BR)	Breakdown Voltage		
V _(CL)	Clamping Voltage		
I _{pp}	Peak Pulse Current		
α _T	Temperature Coefficient of V _(BR)		
C	Capacitance		
t _{clamping}	Clamping Time (0 volt to V _(BR))	Unidirectional Types	1 ps max.
		Bidirectional Types	5 ns max.

Types		Marking		I _{RM} @ V _{RM} max.		V _(BR) * @ I _R			V _(CL) @ I _{pp} max.		V _(CL) @ I _{pp} max.		α _T max.	C** typ V _R =0 f=1MHz	
Unidirectional	Bidirectional	Unidirectional	Bidirectional	(μA)	(V)	min.	nom.	max.	(mA)	(V)	(A)	(V)	(A)	(10 ⁻⁴ °C)	(pF)
SM6T6V8	SM6T6V8C	DD	LD	1000	5.5	6.12	6.8	7.48	10	10.8	55	14	250	5.7	4000
SM6T6V8A	SM6T6V8CA	DE	LE	1000	5.8	6.45	6.8	7.14	10	10.5	57	13.4	261	5.7	4000
SM6T7V5	SM6T7V5C	DF	LF	500	6.05	6.75	7.5	8.25	10	11.7	51	15.2	230	6.1	3700
SM6T7V5A	SM6T7V5CA	DG	LG	500	6.4	7.13	7.5	7.88	10	11.3	53	14.5	241	6.1	3700
SM6T10	SM6T10C	DN	LN	10	8.1	9.0	10	11	1	15	40	19.5	369	7.3	2800
SM6T10A	SM6T10CA	DP	LP	10	8.55	9.5	10	10.5	1	14.5	41	18.6	387	7.3	2800
SM6T12	SM6T12C	DS	LS	5	9.72	10.8	12	13.2	1	17.3	35	22.7	317	7.8	2300
SM6T12A	SM6T12CA	DT	LT	5	10.2	11.4	12	12.6	1	16.7	36	21.7	332	7.8	2300
SM6T15	SM6T15C	DW	LW	5	12.1	13.5	15	16.5	1	22	27.5	28.4	254	8.4	1900
SM6T15A	SM6T15CA	DX	LX	5	12.8	14.3	15	15.8	1	21.2	28	27.2	265	8.4	1900
SM6T18	SM6T18C	ED	MD	5	14.5	16.2	18	19.8	1	26.5	22.5	34	212	8.8	1600
SM6T18A	SM6T18CA	EE	ME	5	15.3	17.1	18	18.9	1	25.2	24	32.5	222	8.8	1600
SM6T22	SM6T22C	EH	MH	5	17.8	19.8	22	24.2	1	31.9	18.5	41.2	175	9.2	1350
SM6T22A	SM6T22CA	EK	MK	5	18.8	20.9	22	23.1	1	30.6	20	39.3	183	9.2	1350
SM6T24	SM6T24C	EL	ML	5	19.4	21.6	24	26.4	1	34.7	17.5	44.9	160	9.4	1250
SM6T24A	SM6T24CA	EM	MM	5	20.5	22.8	24	25.2	1	33.2	18	42.8	168	9.4	1250
SM6T27	SM6T27C	EN	MN	5	21.8	24.3	27	29.7	1	39.1	15.5	50.5	143	9.6	1150
SM6T27A	SM6T27CA	EP	MP	5	23.1	25.7	27	28.4	1	37.5	16	48.3	149	9.6	1150
SM6T30	SM6T30C	EQ	MQ	5	24.3	27	30	33	1	43.5	13.5	56.1	128	9.7	1075
SM6T30A	SM6T30CA	ER	MR	5	25.6	28.5	30	31.5	1	41.4	14.5	53.5	134	9.7	1075
SM6T33	SM6T33C	ES	MS	5	26.8	29.7	33	36.3	1	47.7	12.5	61.7	117	9.8	1000
SM6T33A	SM6T33CA	ET	MT	5	28.2	31.4	33	34.7	1	45.7	13.1	59	122	9.8	1000
SM6T36	SM6T36C	EU	MU	5	29.1	32.4	36	39.6	1	52	11.5	67.3	107	9.9	950
SM6T36A	SM6T36CA	EV	MV	5	30.8	34.2	36	37.8	1	49.9	12	64.3	112	9.9	950
SM6T39	SM6T39C	EW	MW	5	31.6	35.1	39	42.9	1	56.4	10.6	73	99	10.0	900
SM6T39A	SM6T39CA	EX	MX	5	33.3	37.1	39	41	1	53.9	11.1	69.7	103	10.0	900
SM6T68	SM6T68C	FP	NP	5	55.1	61.2	68	74.8	1	98	6.1	127	57	10.4	625
SM6T68A	SM6T68CA	FO	NO	5	58.1	64.6	68	71.4	1	92	6.5	121	59.5	10.4	625
SM6T100	SM6T100C	FX	NX	5	81	90	100	110	1	144	4.2	187	38.5	10.6	500
SM6T100A	SM6T100CA	FY	NY	5	85.5	95	100	105	1	137	4.4	178	40.5	10.6	500
SM6T150	SM6T150C	GK	OK	5	121	135	150	165	1	215	2.8	277	26	10.8	400
SM6T150A	SM6T150CA	GL	OL	5	128	143	150	158	1	207	2.9	265	27.2	10.8	400
SM6T200	SM6T200C	GT	OT	5	162	180	200	220	1	287	2.1	370	19.4	10.8	350
SM6T200A	SM6T200CA	GU	OU	5	171	190	200	210	1	274	2.2	353	20.4	10.8	350
SM6T220		GV		5	178	198	220	242	1	316	1.9	406	17.7	10.8	330
SM6T220A		GW		5	188	209	220	231	1	301	2	388	18.6	10.8	330

* Pulse test t_c ≤ 50 ms δ < 2 %.

** Divide these values by 2 for bidirectional types

For bidirectional types, electrical characteristics apply in both directions

ORDER CODE

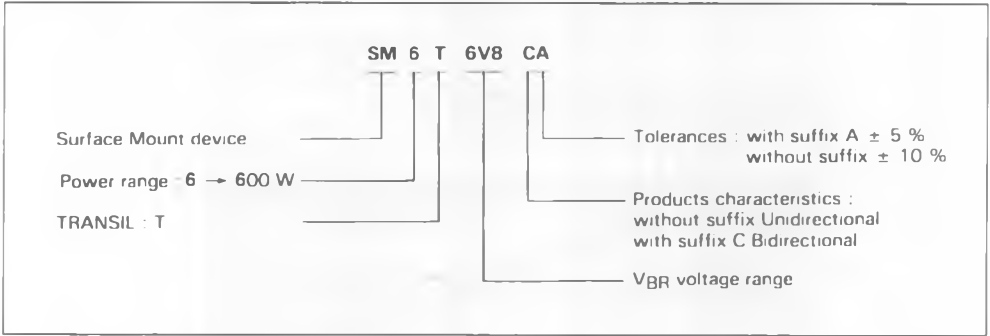

PACKAGE MECHANICAL DATA

SOD 6 Plastic

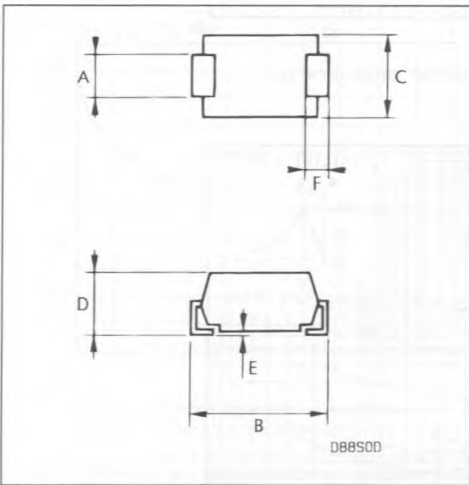

Ref.	Millimetres		Inches	
	Min.	Max.	Min.	Max.
A	2.8	3.2	0.110	0.126
B	6.0	6.4	0.236	0.252
C	3.8	4.2	0.150	0.165
D	2.5	3.1	0.098	0.122
E	-	0.1	-	0.004
F	0.9	1.3	0.035	0.051

Laser marking.
The logo indicates cathode for unidirectional types.

FOOT PRINT DIMENSIONS (Millimeters)

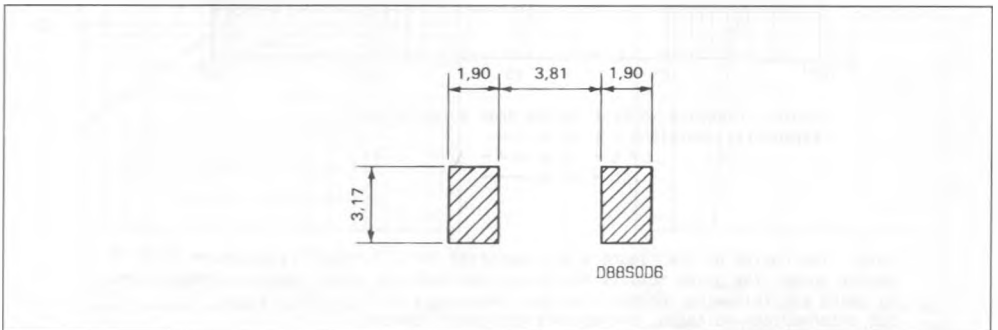

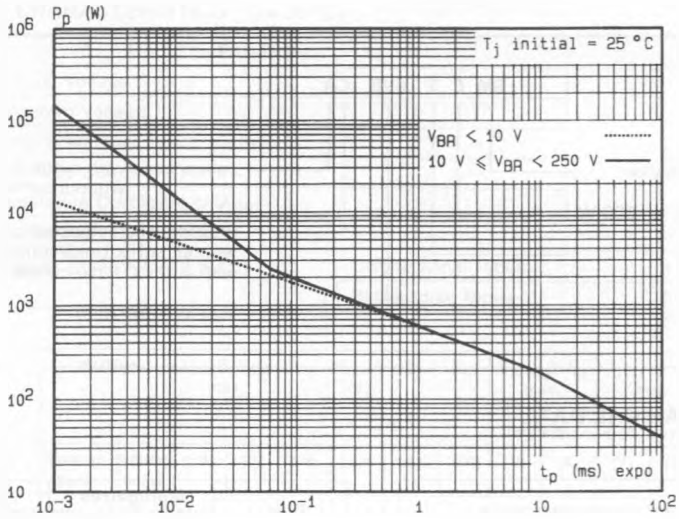

Fig.1 - Peak pulse power versus exponential pulse duration.

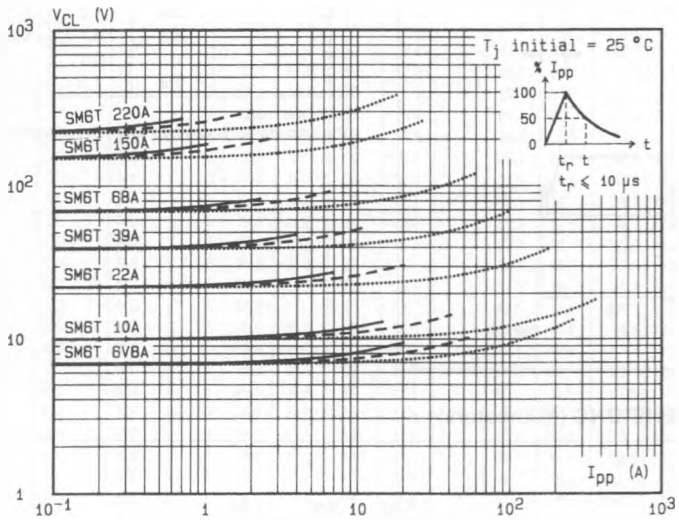

Fig.2 - Clamping voltage versus peak pulse current.
 exponential waveform $t = 20 \mu s$
 $t = 1 ms$ ----
 $t = 10 ms$ ——

Note : The curves of the figure 2 are specified for a junction temperature of 25 °C before surge. The given results may be extrapolated for other junction temperatures by using the following formula : $\Delta V(BR) = \alpha_T (V(BR)) \times [T_j - 25] \times V(BR)$
 For intermediate voltages, extrapolate the given results.

088SM6TP4

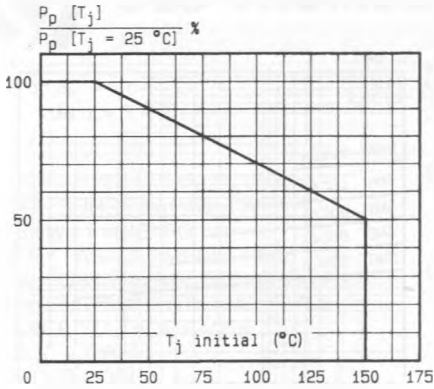

Fig.3 - Allowable power dissipation versus junction temperature.

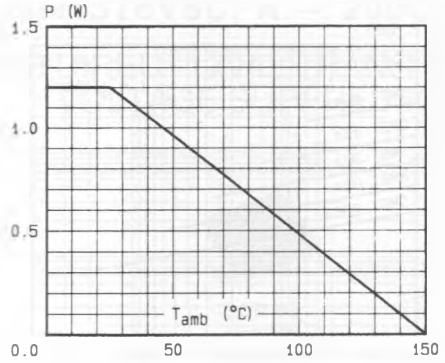

Fig.4 - Power dissipation versus ambient temperature.

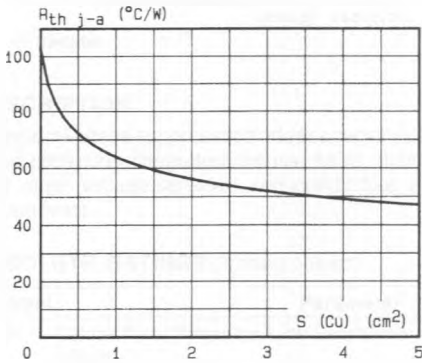

Fig.5 - Thermal resistance junction-ambient versus Cu surface (printed circuit).

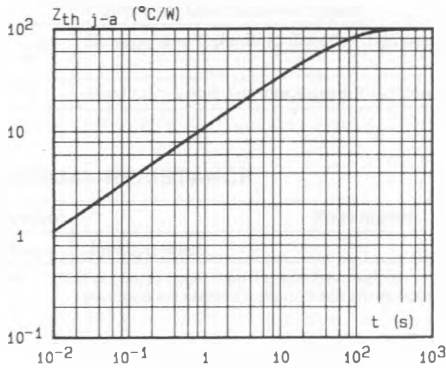

Fig.6 - Transient thermal impedance junction-ambient versus pulse duration.

DB8SM6TP5

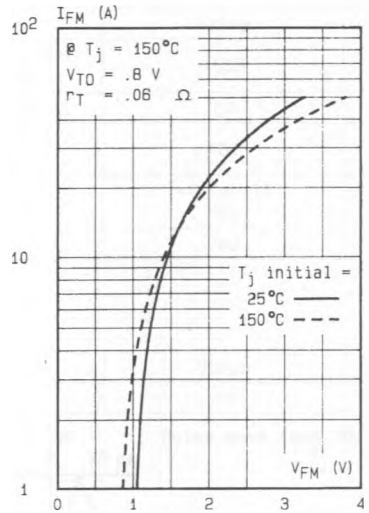

Fig.7 - Peak forward current versus peak forward voltage drop (typical values for unidirectional types).

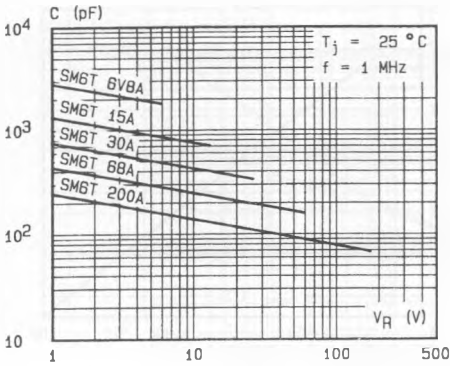

Fig.8a - Capacitance versus reverse applied voltage for unidirectional types (typical values).

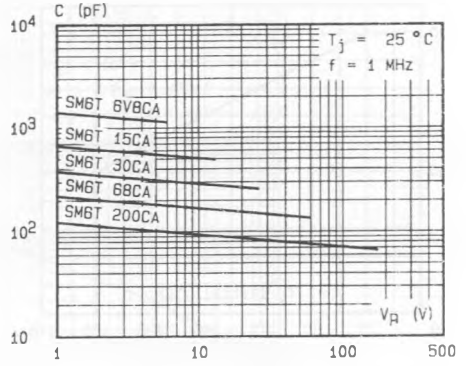

Fig.8b - Capacitance versus reverse applied voltage for bidirectional types (typical values).

DB85M6TP6