

TURBOSWITCH™ "A". ULTRA-FAST HIGH VOLTAGE DIODE

MAIN PRODUCTS CHARACTERISTICS

$I_{F(AV)}$	5A
V_{RRM}	1200V
t_{rr} (typ)	45ns
V_F (max)	2.0V

FEATURES AND BENEFITS

- ULTRA-FAST, SOFT AND NOISE-FREE RECOVERY.
- VERY LOW OVERALL POWER LOSSES IN BOTH THE DIODE AND THE COMPANION TRANSISTOR.
- HIGH FREQUENCY AND/OR HIGH PULSED CURRENT OPERATIONS.

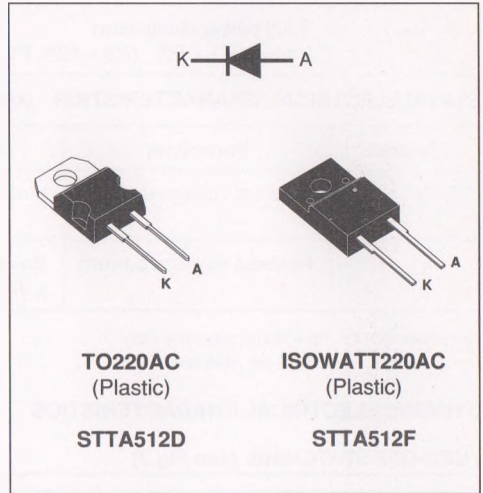

DESCRIPTION

The TURBOSWITCH is a very high performance series of ultra-fast high voltage power diodes from 600V to 1200V. TURBOSWITCH 1200V drastically cuts losses in all high voltage operations which require extremely fast, soft and noise-free power diodes. Due to their optimized switching performances they also highly decrease power losses in any associated switching IGBT or MOSFET in all "Freewheel

Mode" operations. They are particularly suitable in Motor Control circuitries, or in the primary of SMPS as snubber, clamping or demagnetizing diodes, and also at the secondary of SMPS as high voltage rectifier diodes. Packaged in TO220AC and in ISOWATT220AC, these 1200V devices are particularly intended for use on 3 phase 400V industrial mains.

ABSOLUTE MAXIMUM RATINGS

Symbol	Parameter	Value	Unit
V_{RRM}	Repetitive peak reverse voltage	1200	V
V_{RSM}	Non repetitive peak reverse voltage	1200	V
$I_{F(RMS)}$	RMS forward current	20	A
I_{FRM}	Repetitive peak forward current ($t_p = 5 \mu s$, $f = 5kHz$)	75	A
T_j	Max operating junction temperature	150	°C
T_{stg}	Storage temperature	-65 to 150	°C

THERMAL AND POWER DATA

Symbol	Parameter	Conditions	Value	Unit
$R_{th(j-c)}$	Junction to case thermal resistance	STTA512D STTA512F	4.0 5.5	$^{\circ}\text{C}/\text{W}$
P_1	Conduction power dissipation (see fig. 6)	$I_{F(AV)} = 5\text{ A}$ $\delta = 0.5$ STTA512D $T_c = 102^{\circ}\text{C}$ STTA512F $T_c = 84^{\circ}\text{C}$	12	W
P_{max}	Total power dissipation $P_{max} = P_1 + P_3$ ($P_3 = 10\% P_1$)	STTA512D $T_c = 98^{\circ}\text{C}$ STTA512F $T_c = 78^{\circ}\text{C}$	13	W

STATIC ELECTRICAL CHARACTERISTICS (see Fig.6)

Symbol	Parameter	Test Conditions		Min	Typ	Max	Unit
V_F	Forward voltage drop	$I_F = 5\text{ A}$	$T_j = 25^{\circ}\text{C}$ $T_j = 125^{\circ}\text{C}$			2.2 2.0	V V
I_R	Reverse leakage current	$V_R = 0.8$ $\times V_{RRM}$	$T_j = 25^{\circ}\text{C}$ $T_j = 125^{\circ}\text{C}$			100 2.0	μA mA

Test pulses widths : * $t_p = 380\ \mu\text{s}$, duty cycle < 2%

** $t_p = 5\ \text{ms}$, duty cycle < 2%

DYNAMIC ELECTRICAL CHARACTERISTICS

TURN-OFF SWITCHING (see Fig.7)

Symbol	Parameter	Test Conditions	Min	Typ	Max	Unit
t_{rr}	Reverse recovery time	$T_j = 25^{\circ}\text{C}$ $I_F = 0.5\ \text{A}$ $I_R = 1\ \text{A}$ $I_{rr} = 0.25\text{ A}$ $I_F = 1\ \text{A}$ $di_F/dt = -50\text{ A}/\mu\text{s}$ $V_R = 30\text{ V}$		45	95	ns
I_{RM}	Maximum reverse recovery current	$T_j = 125^{\circ}\text{C}$ $V_R = 600\text{ V}$ $I_F = 5\text{ A}$ $di_F/dt = -40\ \text{A}/\mu\text{s}$ $di_F/dt = -500\ \text{A}/\mu\text{s}$		20	7.5	A
S factor	Softness factor	$T_j = 125^{\circ}\text{C}$ $V_R = 600\text{ V}$ $I_F = 5\text{ A}$ $di_F/dt = -500\ \text{A}/\mu\text{s}$		1.2		/

TURN-ON SWITCHING (see Fig.8)

Symbol	Parameter	Test Conditions	Min	Typ	Max	Unit
t_{fr}	Forward recovery time	$T_j = 25^{\circ}\text{C}$ $I_F = 5\ \text{A}$, $di_F/dt = 40\ \text{A}/\mu\text{s}$ measured at, $1.1 \times V_{Fmax}$			900	ns
V_{FP}	Peak forward voltage	$T_j = 25^{\circ}\text{C}$ $I_F = 5\text{ A}$, $di_F/dt = 40\ \text{A}/\mu\text{s}$ $I_F = 40\text{ A}$, $di_F/dt = 500\ \text{A}/\mu\text{s}$			35 50	V

APPLICATION DATA

The 1200V TURBOSWITCH series has been designed to provide the lowest overall power losses in all high frequency or high pulsed current operations. In such applications (Fig 1 to 5), the way of calculating the power losses is given below :

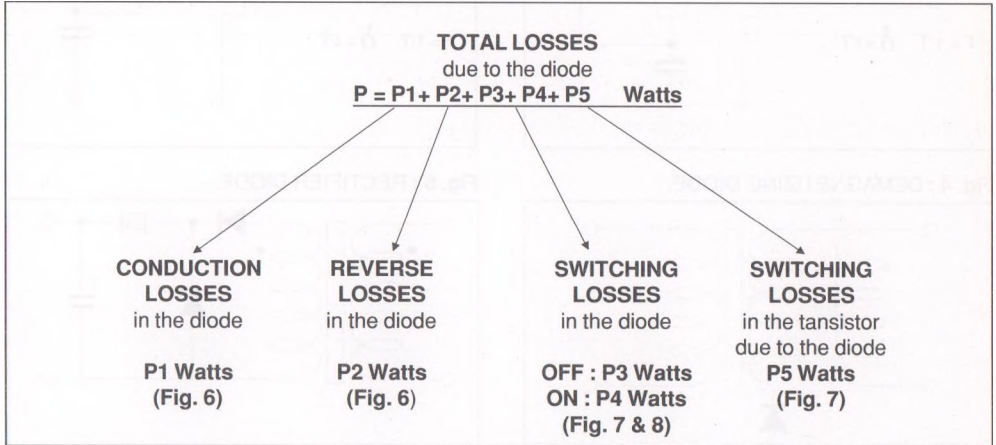

Fig. 1 : "FREEWHEEL" MODE.

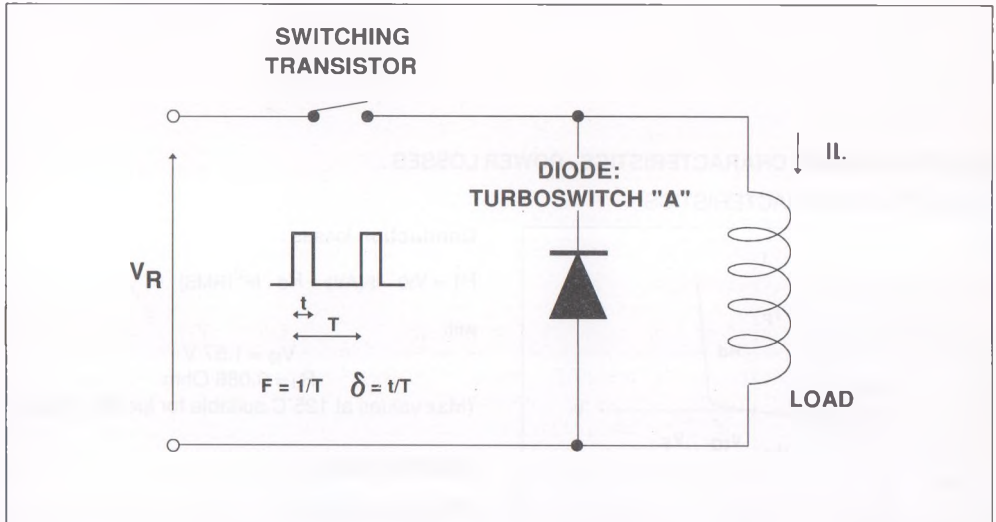

Fig. 2 : SNUBBER DIODE.

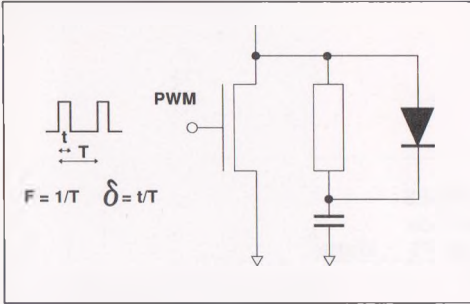

Fig. 3 : CLAMPING DIODE.

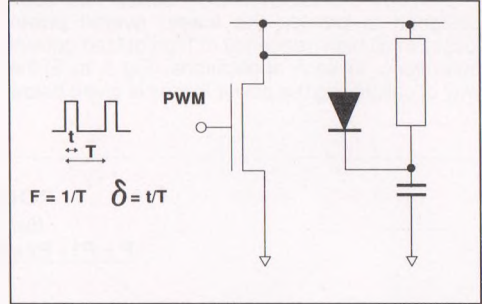

Fig. 4 : DEMAGNETIZING DIODE.

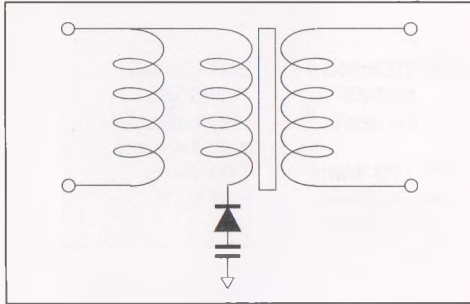
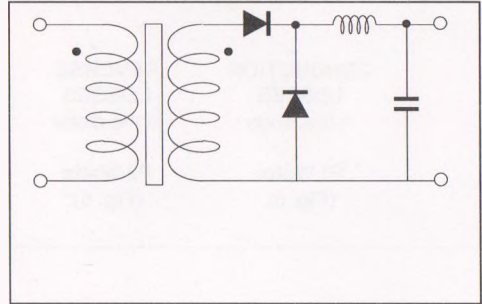
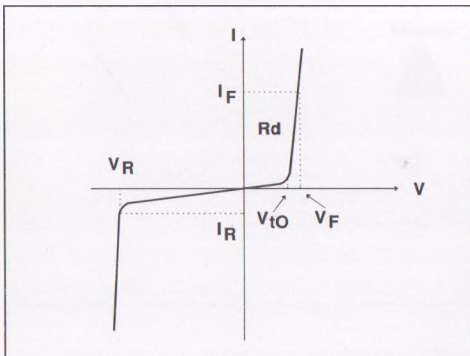

Fig. 5 : RECTIFIER DIODE.



STATIC & DYNAMIC CHARACTERISTICS . POWER LOSSES .

Fig. 6: STATIC CHARACTERISTICS



Conduction losses :

$$P1 = V_{t0} \cdot I_{F(AV)} + R_d \cdot I_{F(RMS)}^2$$

with

$$V_{t0} = 1.57 \text{ V}$$

$$R_d = 0.086 \text{ Ohm}$$

(Max values at 125°C, suitable for $I_{peak} < 3 \cdot I_{F(av)}$)

Reverse losses :

$$P2 = V_R \cdot I_R \cdot (1 - \delta)$$

APPLICATION DATA (Cont'd)

Fig. 7: TURN-OFF CHARACTERISTICS

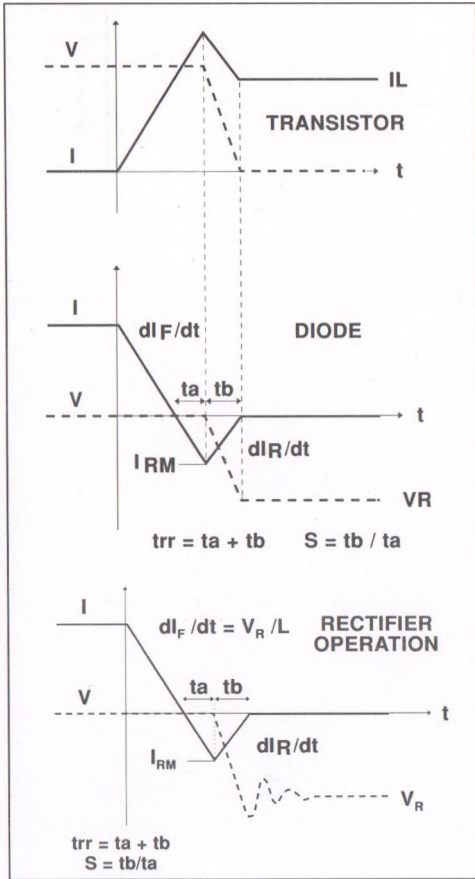
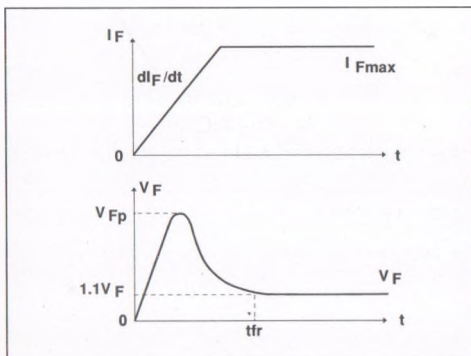

Fig. 8: TURN-ON CHARACTERISTICS



Turn-on losses :
(in the transistor, due to the diode)

$$P5 = \frac{V_R \times I_{RM}^2 \times (3 + 2 \times S) \times F}{6 \times dI_F/dt} + \frac{V_R \times I_{RM} \times I_L \times (S + 2) \times F}{2 \times dI_F/dt}$$

Turn-off losses (in the diode) :

$$P3 = \frac{V_R \times I_{RM}^2 \times S \times F}{6 \times dI_F/dt}$$

Turn-off losses :
(with non negligible serial inductance)

$$P3' = \frac{V_R \times I_{RM}^2 \times S \times F}{6 \times dI_F/dt} + \frac{L \times I_{RM}^2 \times F}{2}$$

P3, P3' and P5 are suitable for power MOSFET and IGBT

Turn-on losses :

$$P4 = 0.4 (V_{FP} - V_F) \cdot I_{Fmax} \cdot t_{tr} \cdot F$$