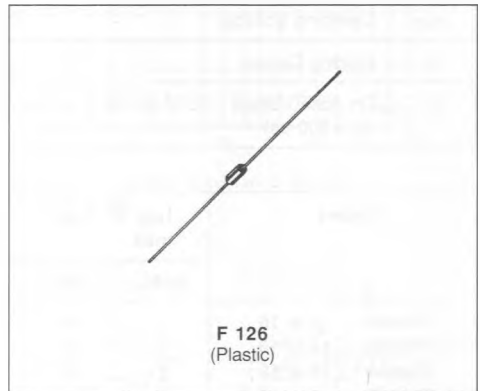

**TRISIL**

- BIDIRECTIONAL DEVICE USED TO **TELEPHONE PROTECTION**
- CHARACTERISTIC OF STAND-OFF AND BREAKDOWN VOLTAGE SIMILAR TO A TRANSIL ( $V_{off}$ )
- HIGH FLOWOUT CAPABILITY BECAUSE OF ITS BREAKOVER CHARACTERISTIC ( $V_{on}$ )

**ABSOLUTE RATINGS** (limiting values) ( $T_J = 25\text{ }^\circ\text{C}$  -  $L = 10\text{ mm}$ )

Symbol	Parameter		Value	Unit
P	Power Dissipation on Infinite Heatsink	$T_{amb} = 50\text{ }^\circ\text{C}$	1.7	W
$I_{pp}$	Peak Pulse Current	1 ms expo	50	A
		8-20 $\mu\text{s}$ expo	100	
$I_{TSM}$	Non Repetitive Surge Peak on-state Current	$t_p = 20\text{ ms}$	30	A
di/dt	Critical Rate of Rise of on-state Current	Non Repetitive	100	A/ $\mu\text{s}$
dv/dt	Critical Rate of Rise of off-state Voltage	67 % $V_{(BR)}$ min	5	kV/ $\mu\text{s}$
$T_{stg}$ $T_J$	Storage and Operating Junction Temperature Range		- 40 to 150	$^\circ\text{C}$
			150	$^\circ\text{C}$
$T_L$	Maximum Lead Temperature for Soldering During 10 s at 4 mm from Case		230	$^\circ\text{C}$

**THERMAL RESISTANCES**

Symbol	Parameter		Value	Unit
$R_{th(j-l)}$	Junction-leads on Infinite Heatsink	$L = 10\text{ mm}$	60	$^\circ\text{C/W}$
$R_{th(j-a)}$	Junction-ambient on Printed Circuit		100	$^\circ\text{C/W}$

**ELECTRICAL CHARACTERISTICS**  
( $T_j = 25\text{ }^\circ\text{C}$ )

Symbol	Parameter
$V_{RM}$	Stand-off Voltage
$V_{BR}$	Breakdown Voltage
$V_{BO}$	Clamping Voltage
$I_H$	Holding Current
$V_T$	On-state Voltage : 2.5 V typ. @ $I_T = 1\text{ A}$ ( $t_p = 300\text{ }\mu\text{s}$ )

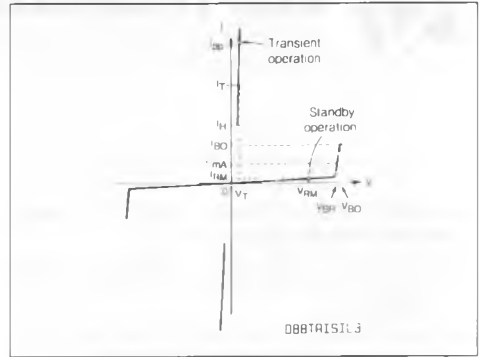

Types	$I_{RM}$ @ $V_{RM}$ max.		$V_{(BR)}$ @ $I_R$ min.		$V_{BO}$ max.	$I_{BO}$ max.	$I_H$ min.
	( $\mu\text{A}$ )	(V)	(V)	(mA)	(V)	(mA)	(mA)
TPA62A - 12 or 18	2	56	62	1	82	800	12 Suffix for 120 mA
(1) TPA62B - 12 or 18	2	56	62	1	75	800	
TPA68A - 12 or 18	2	61	68	1	90	800	
(1) TPA68B - 12 or 18	2	61	68	1	82	800	
(1) TPA75A - 12 or 18	2	67	75	1	100	800	
(1) TPA75B - 12 or 18	2	67	75	1	91	800	
(1) TPA82A - 12 or 18	2	74	82	1	109	300	
(1) TPA82B - 12 or 18	2	74	82	1	99	300	
(1) TPA91A - 12 or 18	2	82	91	1	121	300	
(1) TPA91B - 12 or 18	2	82	91	1	110	300	
P TPA100A - 12 or 18	2	90	100	1	133	300	
TPA100B - 12 or 18	2	90	100	1	121	300	
TPA110A - 12 or 18	2	99	110	1	147	300	
TPA110B - 12 or 18	2	99	110	1	133	300	
P TPA120A - 12 or 18	2	108	120	1	160	300	
TPA120B - 12 or 18	2	108	120	1	145	300	
P TPA130A - 12 or 18	2	117	130	1	173	300	
TPA130B - 12 or 18	2	117	130	1	157	300	
(1) TPA150A - 12 or 18	2	135	150	1	200	300	
(1) TPA150B - 12 or 18	2	135	150	1	181	300	
(1) TPA160A - 12 or 18	2	144	160	1	213	300	
(1) TPA160B - 12 or 18	2	144	160	1	193	300	
(1) TPA180A - 12 or 18	2	162	180	1	240	300	
(1) TPA180B - 12 or 18	2	162	180	1	217	300	
(1) TPA200A - 12 or 18	2	180	200	1	267	300	
(1) TPA200B - 12 or 18	2	180	200	1	241	300	
P TPA220A - 12 or 18	2	198	220	1	293	300	
TPA220B - 12 or 18	2	198	220	1	265	300	
P TPA240A - 12 or 18	2	216	240	1	320	300	
TPA240B - 12 or 18	2	216	240	1	289	300	
P TPA270A - 12 or 18	2	243	270	1	360	300	
TPA270B - 12 or 18	2	243	270	1	325	300	

P : Preferred device.  
(1) : These volages are on request. Consult us.

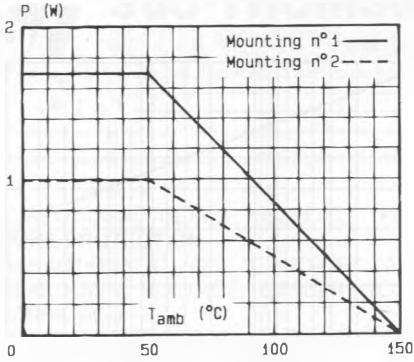

Fig.1 - Power dissipation versus ambient temperature.

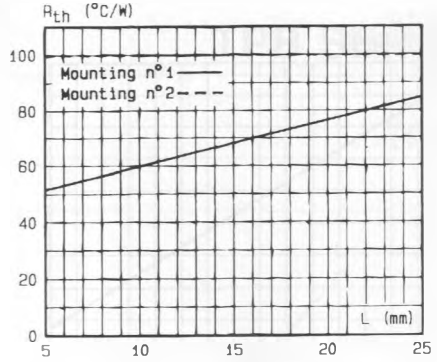

Fig.2 - Thermal resistance versus lead length.

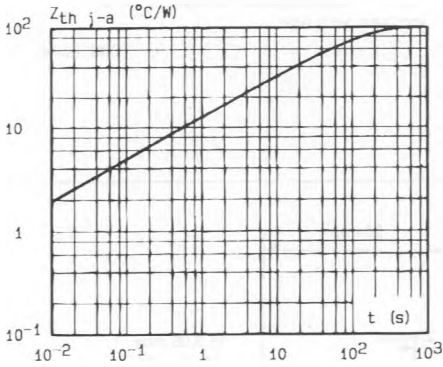

Fig.3 - Transient thermal impedance junction-ambient for mounting n°2 versus pulse duration (L = 10 mm).

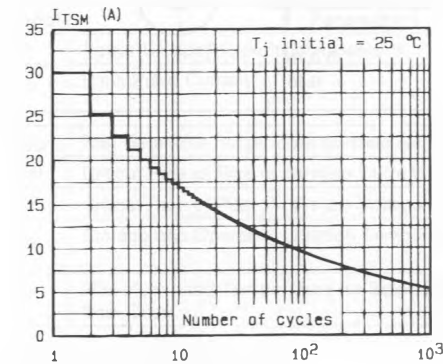
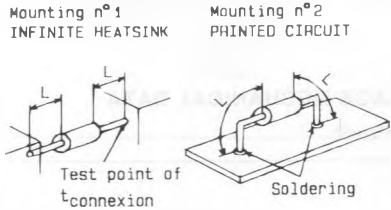

Fig.4 - Non repetitive surge peak on-state current versus number of cycles.

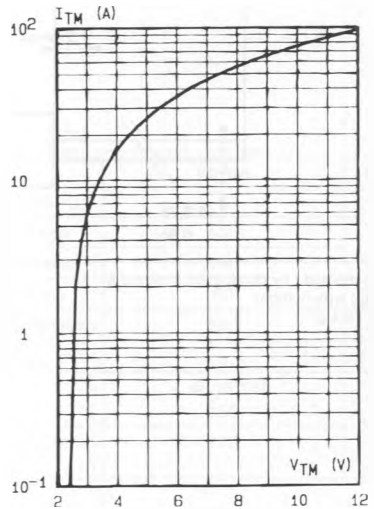

Fig.5 - Peak forward current versus peak forward voltage drop (typical values).

088TPAP3

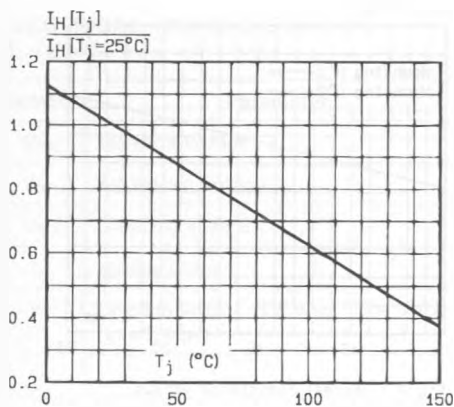

Fig.6 - Relative variation of holding current versus junction temperature.

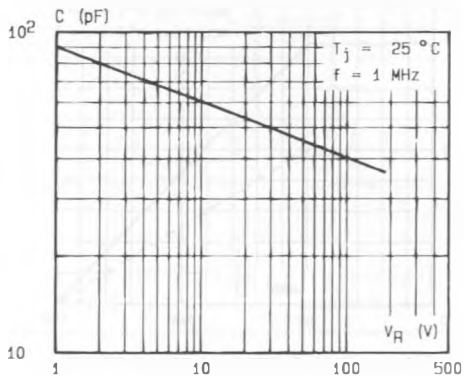
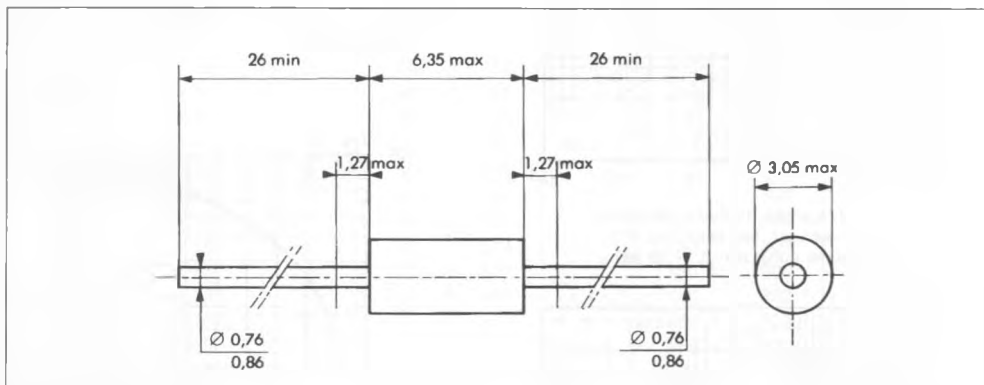

Fig.7 - Capacitance versus reverse applied voltage.

DB8TPA4

PACKAGE MECHANICAL DATA

F 126 Plastic



Cooling method : by conduction (method A)

Marking : type number

Weight : 0.4 g