



T.			$U_{tr}$	$U_p$	$I_o$	$I_p$
			V	V	mA	mA
BA	Syl	1	350	1000	350	1000
BH	amer	1	350	1000	125	400
BR	amer	2	350		50	
RGN 1500	Tlf	3	300		100	
OY 4	amer	4	95	300	40 ÷ 75	500
OZ 3	amer	5	300 ÷ 350	1000	30 ÷ 75	200
OZ 4	int	6				
OZ 4-A	int	6	265 ÷ 365	880	30 ÷ 85	330
1 B 48	amer	7	800	2700	6	50
1024	amer	8		1000	175	480
5517	amer	9	1200	2800	12	100
6174	amer	9	1200	2800	3	30
6436	Ray	11		1500	0,1	10
6659	Ray	12		2800	8	40
6763	Ray	10		2800	12	100



### Equivalents

CK 1003	Ray = OZ 4-A	CK 5517	Ray = 5517	WTT-114	amer = OZ 4
CK 1009	Ray = BA	CK 6174	Ray = 6174	OY 4-G	amer = OY 4
CK 1011 A	Ray = 1 B 48	CK 6436	Ray = 6436	OZ 4-G	int = OZ 4
CK 1013	Ray = 5517	CK 6659	Ray = 6659	1003	amer = OZ 4-A
CK 1024	Ray = 1024	CK 6763	Ray = 6763		

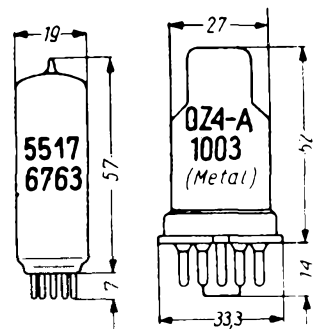
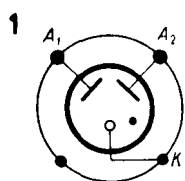

BA

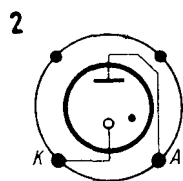

BR

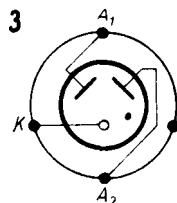

RGN1500

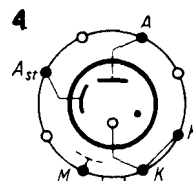

OY4

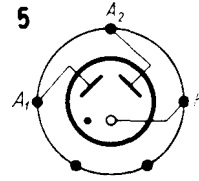

OZ3

