

DISK SEAL POWER TRIODE

Air cooled disk seal power triode of metal-glass design, for use as oscillator, modulator, mixer, amplifier and frequency multiplier up to 3000 Mc/s.

QUICK REFERENCE DATA			
Frequency	f	up to 3000	Mc/s
Cathode current	$I_k = \text{max.}$	125	mA
Anode voltage	$V_a = \text{max.}$	1000	V
Anode dissipation	$W_a = \text{max.}$	100	W
Grid dissipation	$W_g = \text{max.}$	2	W
Mutual conductance	$S =$	25	mA/V
Amplification factor	$\mu =$	100	
Output power	$W_o =$	18	W

HEATING

Indirect by A.C. or D.C.; parallel supply

Heater voltage	$V_f =$	6.3	V
Heater current	$I_f =$	0.95 to 1.1	A
Waiting time	$T_w = \text{min.}$	1	min

Remarks

1. In the interest of long tube life, the heater voltage should be matched to the required cathode current. Under dynamic operation, the back heating of the cathode which occurs at frequencies in the region of transit time must be compensated for by a reduction of heater voltage. Standard values should be taken from the curves on page F. The maximum heater voltage fluctuation should not exceed $\pm 5\%$.
2. For pulsed operation, 6.3 V is normally required for preheating. For C.W. operation preheating should be effected at the voltage indicated by the curve for $f = 500$ Mc/s on page F. In the case of power off periods of up to 5 sec or C.W. operation with $V_a = \text{max.}$ 300 V and $I_k = \text{max.}$ 30 mA, preheating is not necessary.

7Z2 3253

CAPACITANCES

Anode to grid	$C_{ag} > 1.86$	< 2.16	pF
Anode to cathode	C_{ak}	< 0.035	pF
Grid to cathode	$C_{gk} > 5.6$	< 7.6	pF
Anode to cathode ($V_f = 6.3$ V; $I_k = 0$)	C_{ak}	< 0.045	pF
Grid to cathode ($V_f = 6.3$ V; $I_k = 0$)	C_{gk}	< 8.8	pF

MECHANICAL DATA

Dimensions in mm

Net weight: 75 g

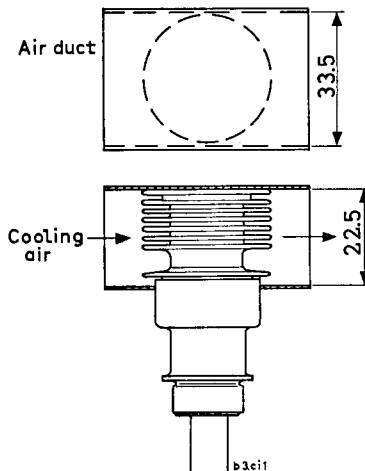
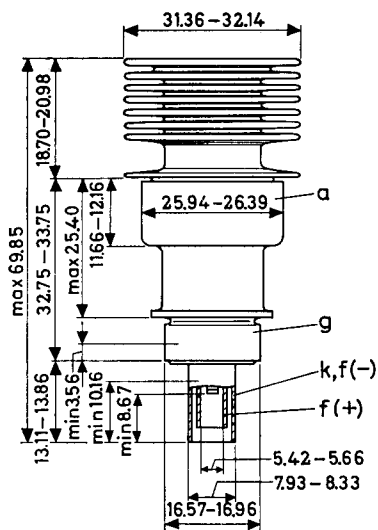

The eccentricity of the contact surfaces is max. 0.5 mm

Mounting position: any

Mounting: where possible, the tube should be mounted in the coaxial resonators with the aid of adequately resilient spring contacts.

COOLING

For maximum anode dissipation and assuming the use of an air duct of the dimensions indicated, an air flow of approx. 350 l/min is required for cooling the radiator in case of an inlet temperature of 25 °C. If necessary, the other surfaces should be cooled as well with a low-velocity air flow. As the constructional design of the ventilation system has to be adapted to the particular type of equipment in use, it cannot be furnished as an accessory together with the tube. The dimensions indicated in the diagram are recommended for the guiding piece for cooling the radiator.

LIMITING VALUES (Absolute limits)

Frequency	f	up to	2500	Mc/s
Anode voltage (unmodulated)	V_a	= max.	1000	V
Anode voltage (100% modulated)	V_a	= max.	600	V
Anode dissipation	W_a	= max.	100	W
Negative grid voltage	$-V_g$	= max.	150	V
Peak negative grid voltage	$-V_{gp}$	= max.	400	V
Peak positive grid voltage	$+V_{gp}$	= max.	30	V
Grid dissipation	W_g	= max.	2	W
Grid current	I_g	= max.	50	mA
Cathode current	I_k	= max.	125	mA
Bulb temperature	t_{bulb}	= max.	175	°C

TYPICAL CHARACTERISTICS

Anode voltage	V_a	=	600		V
Cathode resistor	R_k	=	30		Ω
Anode current	I_a	=	75	> 60	< 95 mA
Mutual conductance	S	=	25	> 20	< 30 mA/V
Amplification factor	μ	=	100		

OPERATING CHARACTERISTICS

C.W. oscillator

Frequency	f	=	2500	2500	Mc/s
Heater voltage	V_f	=	4.5	4.5	V
Anode voltage	V_a	=	600	800	V
Anode current	I_a	=	100	100	mA
Grid current	I_g	=	10	8	mA
Output power	W_o	=	12	18	W

Frequency doubler

Frequency	f	=	1000/2000	Mc/s
Heater voltage	V_f	=	5.6	V
Anode voltage	V_a	=	400	V
Grid voltage	V_g	=	-15	V
Anode current	I_a	=	55	mA
Grid input power	W_{ig}	=	1.5	W
Output power	W_o	=	4.1	W

The tubes satisfy the life tests according to MIL-E-1/546C. The life of the tube depends on the load and particularly on the tube temperature and the anode voltage. It is therefore recommended that the tube output required in each case be attained with the lowest possible anode voltage, and that the tube temperature be kept as low as possible by adequate cooling.

2C39A

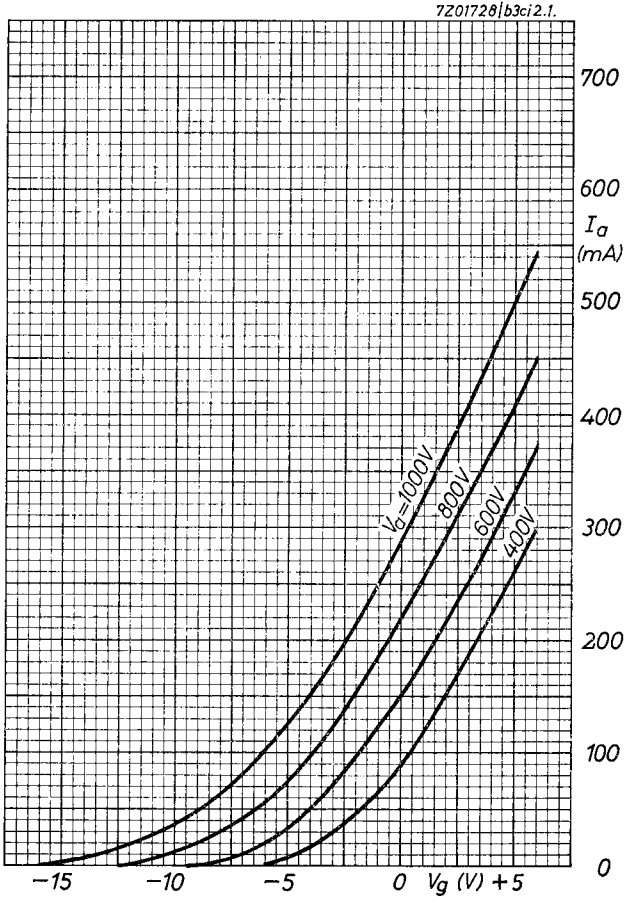

4.4.1965

A

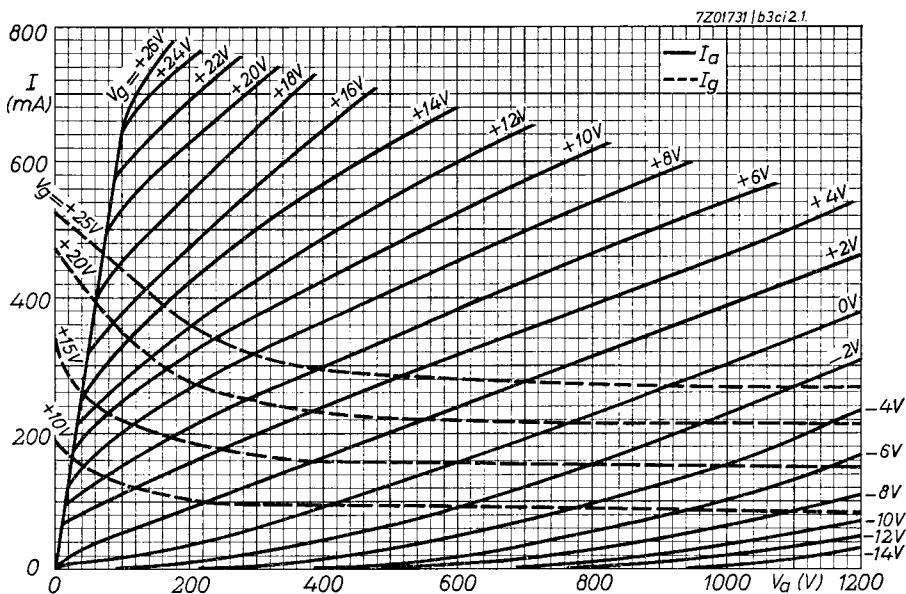

B

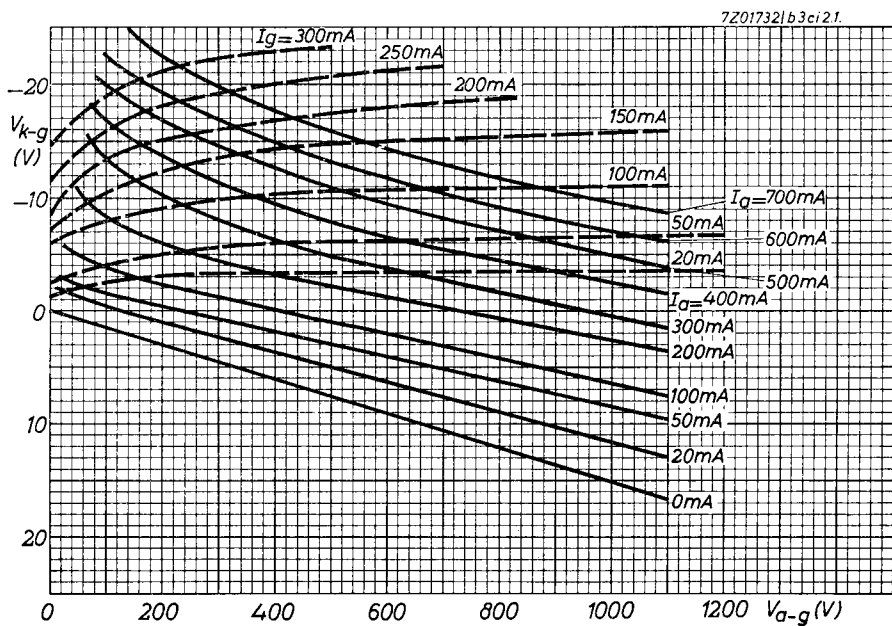

C

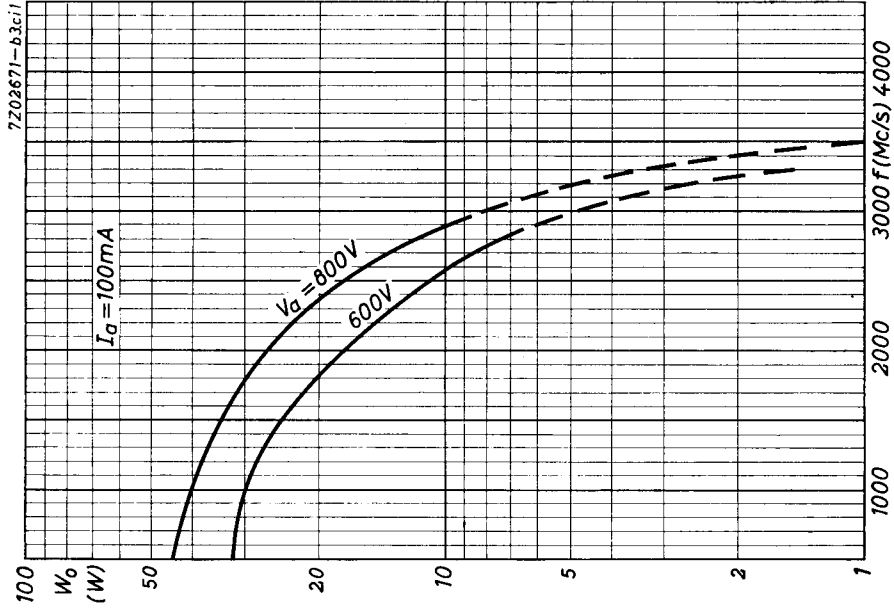

D

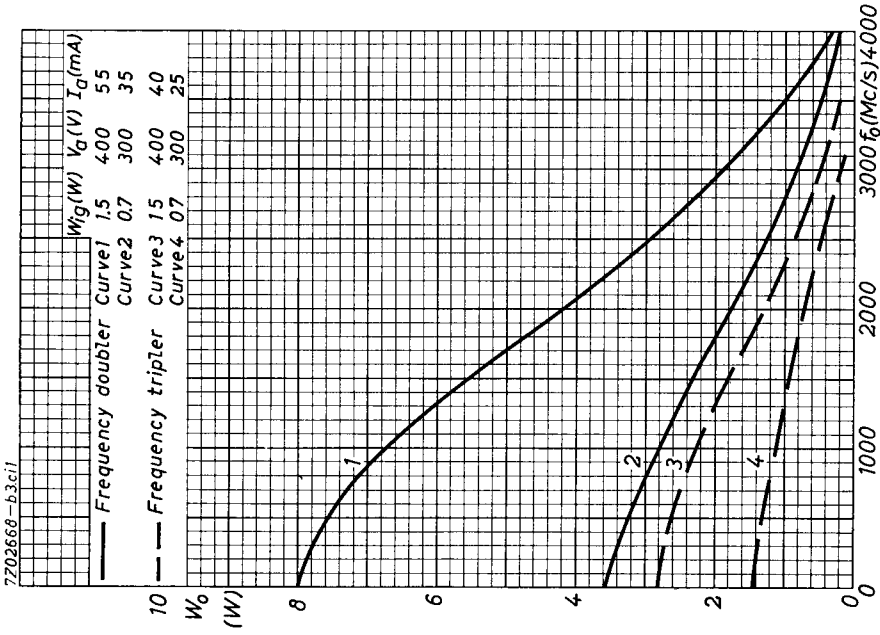

E

F

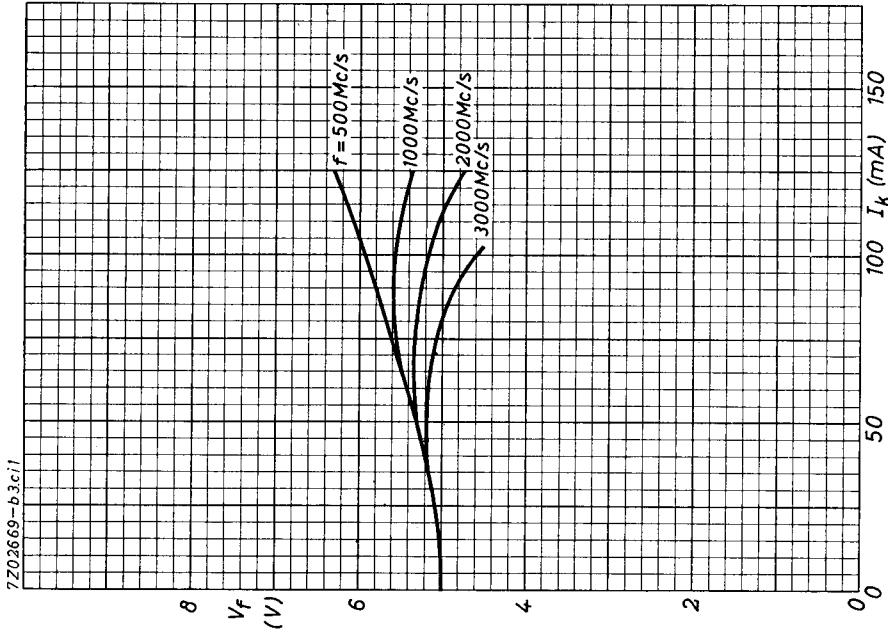

G

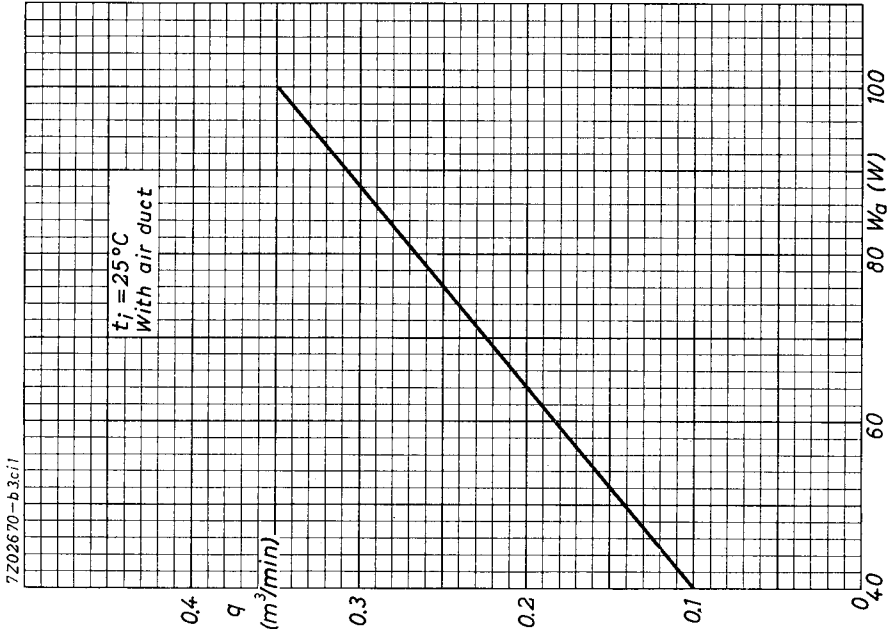

4.4.1965