



# Triode Type ACT 9

HF POWER AMPLIFIER AND OSCILLATOR

**General.** An air-cooled transmitting triode fitted with a tungsten filament, suitable for use at frequencies up to 80 Mc/s. The figures quoted for maximum permissible ratings apply to operation at frequencies up to 15 Mc/s. On higher frequencies the anode voltage must be reduced, and a curve is given showing the maximum permissible anode voltage against frequency. As the efficiency falls with frequency the input must be reduced in order to avoid exceeding the permissible anode dissipation.

**Cooling.** For an anode dissipation up to 800 W (maximum), convection cooling is adequate provided there is at least 12 in. free clearance all around the valve and the air circulation is unrestricted. If forced air cooling is employed the anode dissipation may be increased to 1,100 W (maximum). The volume of air required is 10 cu. ft. per minute equal to a 3-in. head of water. The temperature on the outer surface of the radiator must not exceed 150°C. All cooling supplies must be started before the application of any supply voltages.

**Mounting.** The valve must be mounted vertically with the anode uppermost.

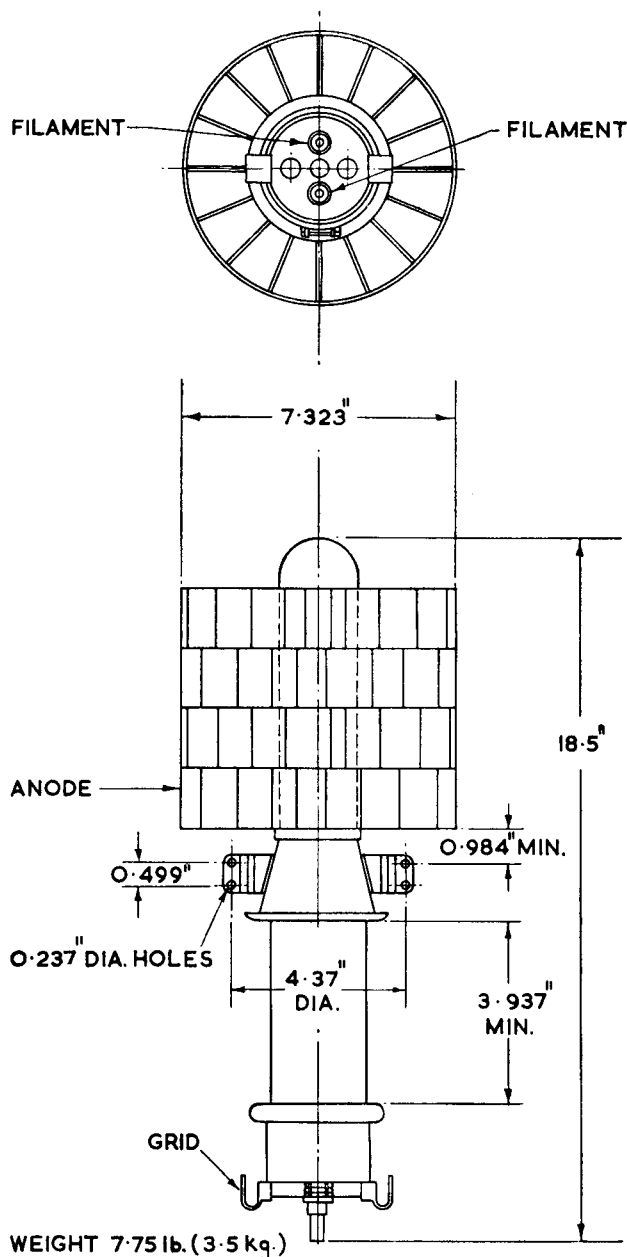

MARCONI'S WIRELESS TELEGRAPH COMPANY LIMITED

Head Office: Marconi House, Chelmsford, England. Telephone: Chelmsford 3221. Telegraphic Address: Expanse, Chelmsford

### APPROXIMATE DATA

$V_f$	16	V*
$I_f$	22	A
$V_a$ (max)	10	kV
$P_a$ (max) Convection cooling	800	W
$P_a$ (max) Forced air cooling	1,100	W
$P_{g1}$ (max)	40	W
$I_{g1}$ (rf) max	14	A
$\mu$	40	
$r_a$	13,000	$\Omega$
$g_m$	3.1	mA/V
$C_{a-g1}$	15.9	pF
$C_{a-k}$	1.6	pF
$C_{g1-k}$	23.2	pF

\* Each valve is marked with the filament voltage to give 2 A emission at 90% saturation.

### (1) HF POWER AMPLIFIER AND OSCILLATOR CLASS C TELEGRAPHY

(Unmodulated, one valve, key down conditions)

Maximum permissible ratings

$V_a$	10,000	V
$I_a$	400	mA
$P_{in}$	3.25 kW	3.9 kW (a)
$I_{g1dc}$	100	mA
$P_a$	800	W 1,100 W (a)

#### Typical Operation

$V_a$	10,000	10,000	7,500	5,000	V
$I_a$	380	320	360	360	mA
$V_{g1}$	-500	-500	-500	-480	V
$I_{g1}$ (c)	50	40	45	50	mA
$R_{g1-k}$	10,000	12,500	11,000	9,600	$\Omega$
$V_{g1}$ (pk)	1,000	925	1,000	1,000	V
$P_{dr}$ (c)	60	50	60	65	W
$Z_a$	12,000	15,000	10,000	6,400	$\Omega$
$P_a$	1,000(a)	760	700	550	W
$P_{out}$	2.8	2.44	2.0	1.25	kW

### (2) HF POWER AMPLIFIER

#### CLASS C

(Grid-modulated, one valve, carrier conditions, permissible modulation 100%)

Maximum permissible ratings

$V_a$	10,000	V
$I_a$	230	mA
$P_{in}$	1.3 kW	1.75 kW(a)
$I_{g1}$	100	mA
$P_a$	800	W 1,100 W(a)

#### Typical Operation

$V_a$	10,000	7,500	10,000	7,500	V
$I_a$	170	225	125	165	mA
$V_{g1}$	-430	-385	-330	-320	V
$I_{g1}$ (c)	3.0	4.0	2.5	3.0	mA
$V_{g1}$ (pk)	560	600	420	480	V
$P_{dr}$ (c) (d)	25	35	12	20	W
$V_{(pk)}$ mod (e)	240	265	180	200	V
$P_{mod}$ (e)	5.0	6.0	3.0	4.0	W
$Z_a$ (mod)	5,800	6,000	5,500	5,000	$\Omega$
$Z_a$	15,000	7,500	19,000	11,000	$\Omega$
$P_a$	1,050(a)	1,090(a)	770	790	W
$P_{out}$	650	600	480	450	W

### (3) HF POWER AMPLIFIER

#### CLASS C

(Anode-modulated, one valve, carrier conditions, permissible modulation 100%)

Maximum permissible ratings

$V_a$	8,000	V
$I_a$	250	mA
$P_{in}$	2	kW
$I_{g1}$	100	mA
$P_a$	530	W

Typical Operation				(4) HF POWER AMPLIFIER CLASS B TELEPHONY			
$V_a$	8,000	5,000	V	<i>(One valve, carrier conditions, permissible modulation 100%)</i>			
$I_a$	225	225	mA	<i>Maximum permissible ratings</i>			
$V_{g1(b)}$	-450	-320	V	$V_a$	10,000	V	
$I_{g1(c)}$	25	30	mA	$I_a$	250	mA	
$v_{g1(pk)}$	800	680	V	$P_{in}$	1.22 kW	1.65 kW(a)	
$P_{dr(c)}$	26	26	W	$I_{g1}$	100	mA	
$P_{mod(e)}$	900	565	W	$P_a$	800	W	1,100 W(a)
$Z_{a(mod)}$	35,000	22,000	$\Omega$	<b>Typical Operation</b>			
$Z_a$	18,000	10,000	$\Omega$	$V_a$	10,000	7,500	10,000
$P_a$	400	300	W		7,500	5,000	V
$P_{out}$	1,400	825	W	$I_a$	160	200	120
					200	150	200
				$V_{g1}$	-175	-100	-175
					-100	-100	-60
				$I_{g1(c)}$	2.0	3.0	1.5
					2.5	5.0	mA
				$v_{g1(pk)}$	235	220	200
					185	220	V
				$P_{dr(c)(d)}$	15	15	10
					12	20	W
				$Z_a$	17,000	10,000	24,000
					13,000	6,700	$\Omega$
				$p_a$	1,070(a)	1,020(a)	790
					765	700	W
				$P_{out}$	530	480	410
					360	300	W

#### NOTES

- (a) With forced air cooling.
- (b) Obtained by grid resistance.
- (c) Subject to wide variation. The figures are approximate only.
- (d) At crest of audio cycle with 100% modulation.
- (e) 100% mod.

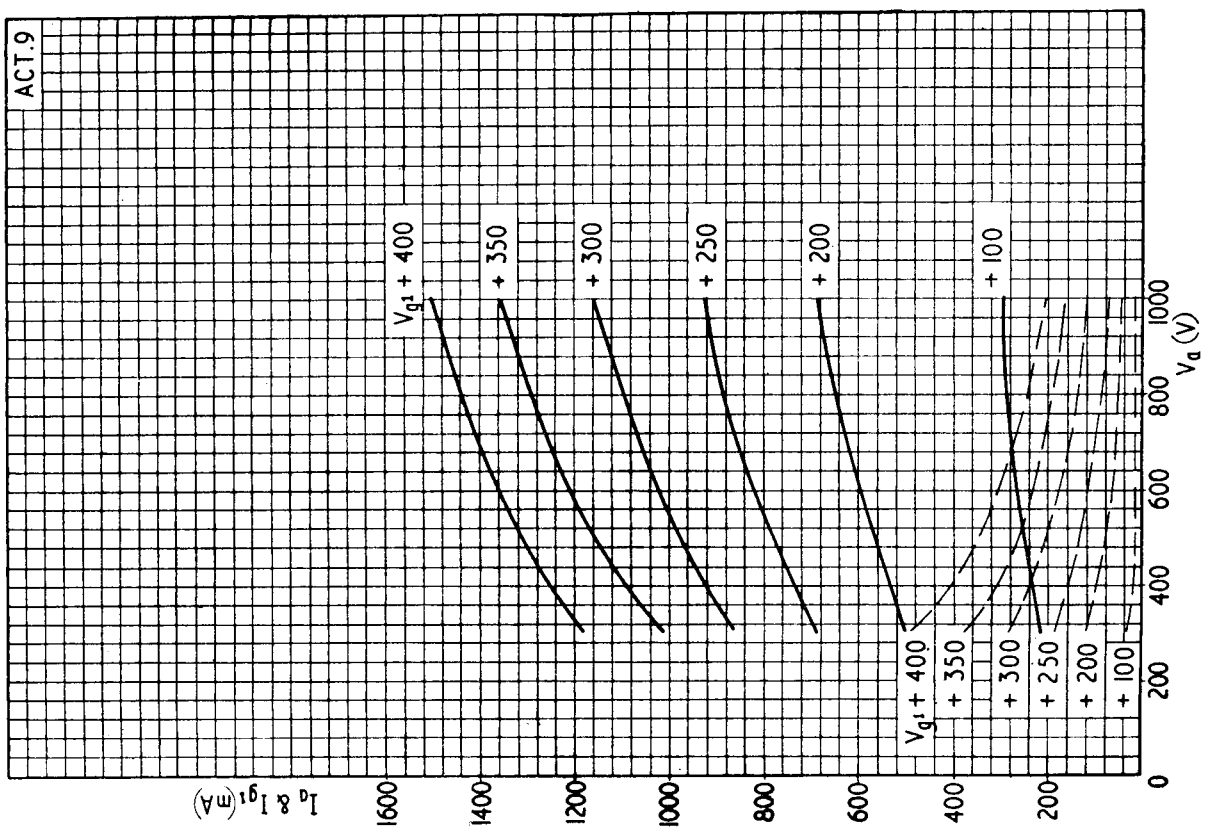
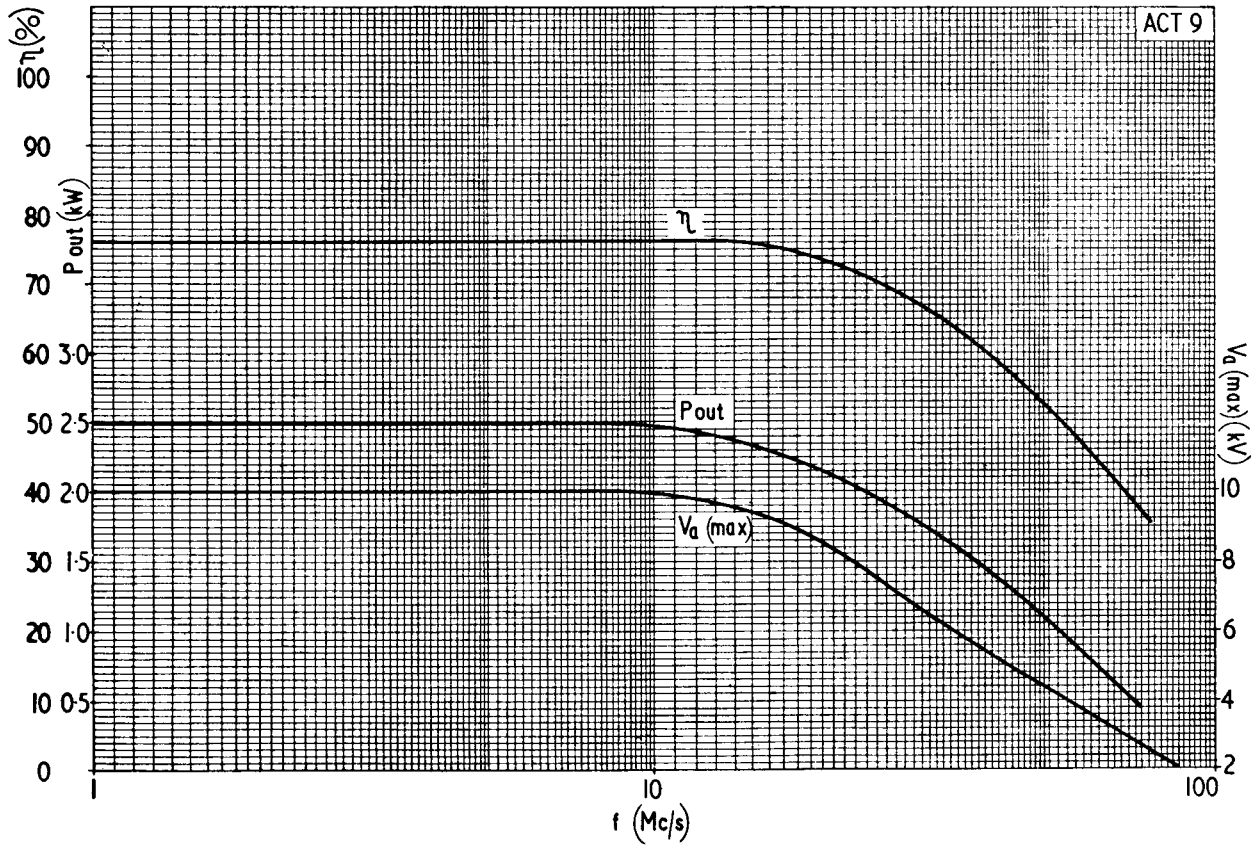

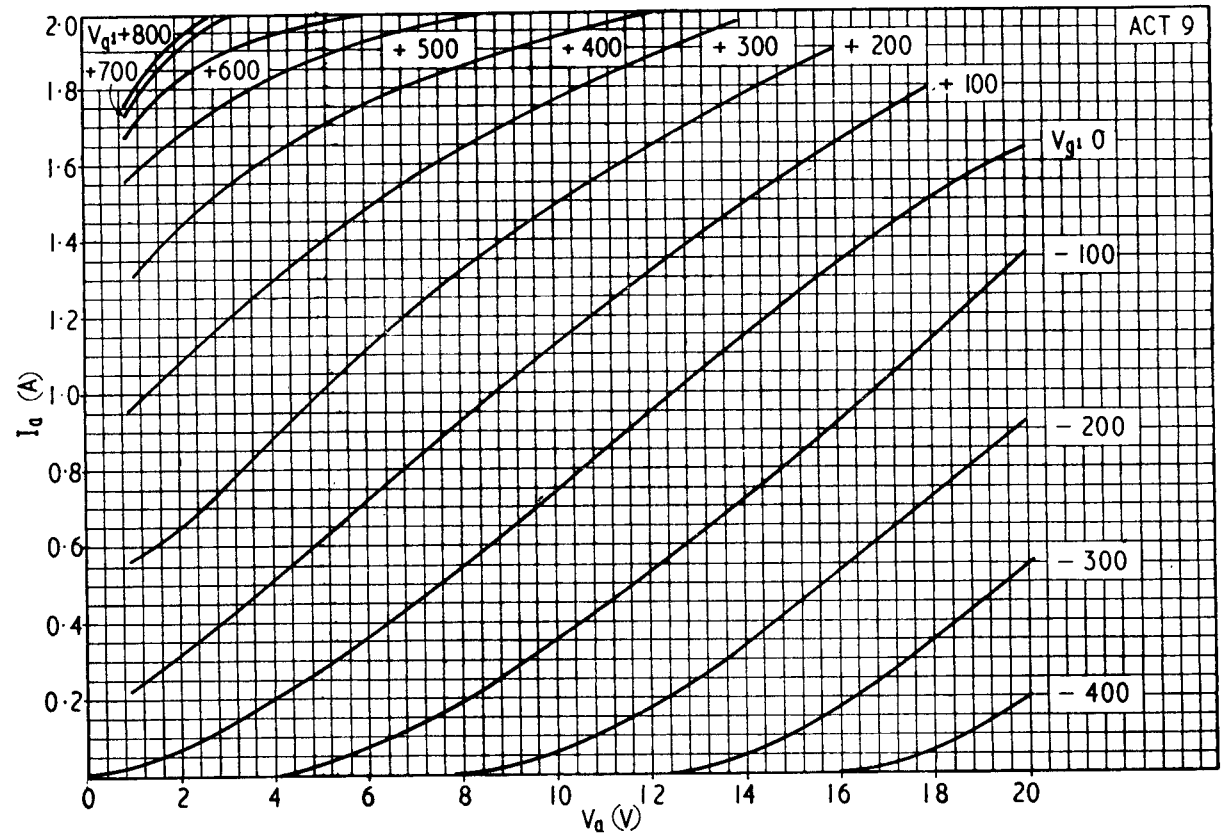
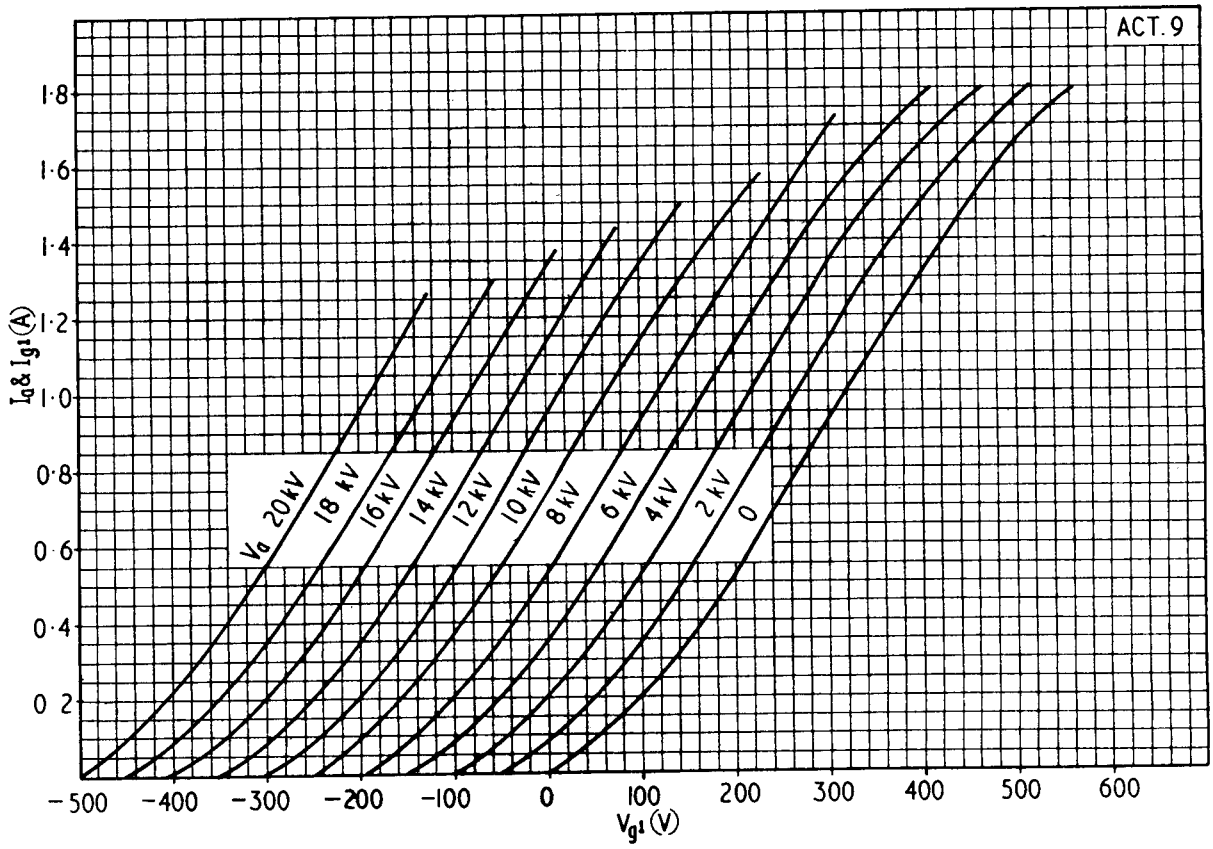

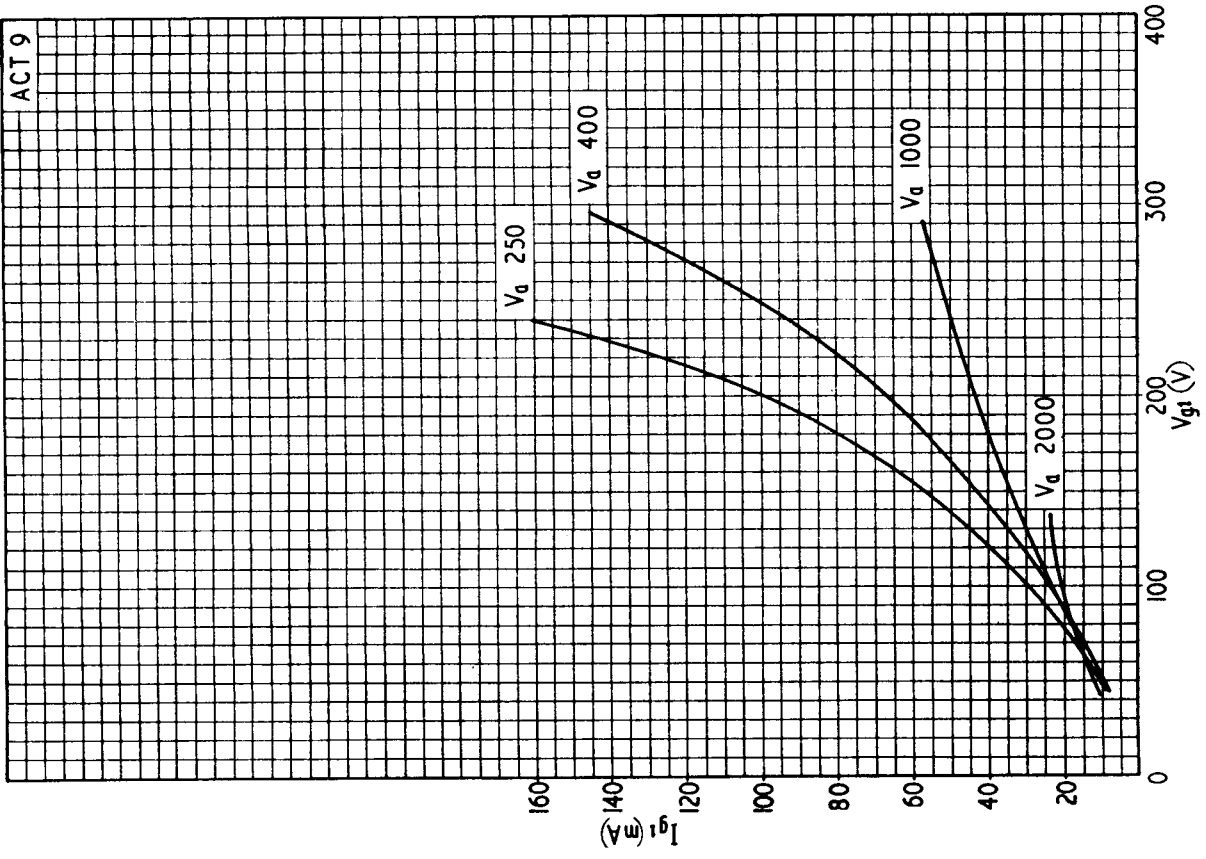
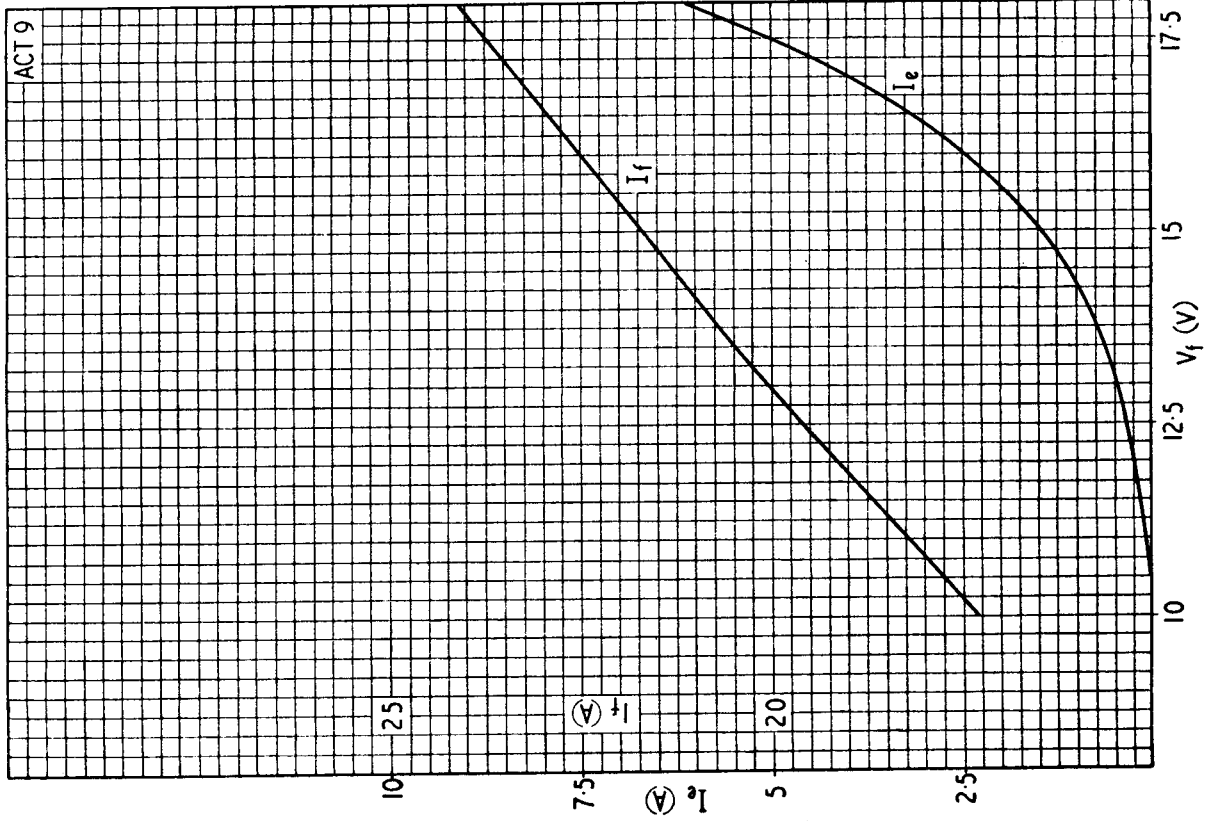





PRINTED IN ENGLAND