

MEDIUM POWER THYRISTORS

Stud Version

Features

- Improved glass passivation for high reliability and exceptional stability at high temperature
- High di/dt and dv/dt capabilities
- Standard package
- Low thermal resistance
- Metric threads version available
- Types up to 1600V V_{DRM}/V_{RRM}

25A

Typical Applications

- Medium power switching
- Phase control applications
- Can be supplied to meet stringent military, aerospace and other high-reliability requirements

Major Ratings and Characteristics

Parameters	25RIA		Units
	10 to 120	140 to 160	
$I_{T(AV)}$	25	25	A
$@ T_C$	85	85	°C
$I_{T(RMS)}$	40	40	A
I_{TSM}	@ 50Hz	398	A
	@ 60Hz	415	A
I^2t	@ 50Hz	795	A ² s
	@ 60Hz	725	A ² s
V_{DRM}/V_{RRM}	100 to 1200	1400 to 1600	V
t_q typical	110		μs
T_J	- 65 to 125		°C



Case Style
TO-208AA (TO-48)

25RIA Series

Bulletin I2402 rev. A 07/00

International
IRF Rectifier

ELECTRICAL SPECIFICATIONS

Voltage Ratings

Type number	Voltage Code	V_{DRM}/V_{RRM} , max. repetitive peak and off-state voltage (1) V	V_{RSM} , maximum non-repetitive peak voltage (2) V	I_{DRM}/I_{RRM} max. @ $T_J = T_J$ max. mA
25RIA	10	100	150	10
	20	200	300	
	40	400	500	
	60	600	700	
	80	800	900	
	100	1000	1100	
	120	1200	1300	
	140	1400	1500	
	160	1600	1700	

(1) Units may be broken over non-repetitively in the off-state direction without damage, if di/dt does not exceed 20A/ μ s

(2) For voltage pulses with $t_p \leq 5$ ms

On-state Conduction

Parameter	25RIA		Units	Conditions			
	10 to 120	140 to 160					
$I_{T(AV)}$ Max. average on-state current @ Case temperature	25	25	A	180° sinusoidal conduction			
	85	85	°C				
$I_{T(RMS)}$ Max. RMS on-state current	40	40	A				
I_{TSM} Max. peak, one-cycle non-repetitive surge current	420	398	A	t = 10ms	No voltage	Sinusoidal half wave, Initial $T_J = T_J$ max.	
	440	415		t = 8.3ms	reapplied		
	350	335		t = 10ms	100% V_{RRM}		
	370	350		t = 8.3ms	reapplied		
I^2t Maximum I^2t for fusing	867	795	A^2s	t = 10ms	No voltage		Sinusoidal half wave, Initial $T_J = T_J$ max.
	790	725		t = 8.3ms	reapplied		
	615	560		t = 10ms	100% V_{RRM}		
	560	510		t = 8.3ms	reapplied		
I^2t Maximum I^2t for fusing	8670	7950	$A^2\sqrt{s}$	t = 0.1 to 10ms, no voltage reapplied, $T_J = T_J$ max.			
$V_{T(TO)1}$ Low level value of threshold voltage	0.99	0.99	V	$(16.7\% \times \pi \times I_{T(AV)} < I < \pi \times I_{T(AV)})$, $T_J = T_J$ max.			
$V_{T(TO)2}$ High level value of threshold voltage	1.40	1.15	V	$(I > \pi \times I_{T(AV)})$, $T_J = T_J$ max.			
r_{t1} Low level value of on-state slope resistance	10.1	11.73	$m\Omega$	$(16.7\% \times \pi \times I_{T(AV)} < I < \pi \times I_{T(AV)})$, $T_J = T_J$ max.			
r_{t2} High level value of on-state slope resistance	5.7	10.05	$m\Omega$	$(I > \pi \times I_{T(AV)})$, $T_J = T_J$ max.			
V_{TM} Max. on-state voltage	1.70	---	V	$I_{pk} = 79$ A, $T_J = 25^\circ C$			
I_H Maximum holding current	130		mA	$T_J = 25^\circ C$. Anode supply 6V, resistive load,			
I_L Latching current	200						

Switching

Parameter	25RIA	Units	Conditions
di/dt Max. rate of rise of turned-on current	$V_{DRM} \leq 600V$ 200 $V_{DRM} \leq 800V$ 180 $V_{DRM} \leq 1000V$ 160 $V_{DRM} \leq 1600V$ 150	A/ μs	$T_J = T_J \text{ max.}$, $V_{DM} = \text{rated } V_{DRM}$ Gate pulse = 20V, 15 Ω , $t_p = 6\mu s$, $t_r = 0.1\mu s \text{ max.}$ $I_{TM} = (2x \text{ rated } di/dt) \text{ A}$
t_{gt} Typical turn-on time	0.9	μs	$T_J = 25^\circ C$, at = rated V_{DRM}/V_{RRM} ; $T_J = 125^\circ C$
t_{rr} Typical reverse recovery time	4		$T_J = T_J \text{ max.}$, $I_{TM} = I_{T(AV)}$; $t_p > 200\mu s$, $di/dt = -10A/\mu s$
t_q Typical turn-off time	110		$T_J = T_J \text{ max.}$, $I_{TM} = I_{T(AV)}$; $t_p > 200\mu s$, $V_R = 100V$, $di/dt = -10A/\mu s$, $dv/dt = 20V/\mu s$ linear to 67% V_{DRM} ; gate bias 0V-100W

(*) $t_q = 10\mu s$ up to 600V, $t_q = 30\mu s$ up to 1600V available on special request.

Blocking

Parameter	25RIA	Units	Conditions
dv/dt Max. critical rate of rise of off-state voltage	100	V/ μs	$T_J = T_J \text{ max.}$ linear to 100% rated V_{DRM}
	300 (*)		$T_J = T_J \text{ max.}$ linear to 67% rated V_{DRM}

(**) Available with: $dv/dt = 1000V/\mu s$, to complete code add S90 i.e. 25RIA160S90.

Triggering

Parameter	25RIA	Units	Conditions
P_{GM} Maximum peak gate power	8.0	W	$T_J = T_J \text{ max.}$
$P_{G(AV)}$ Maximum average gate power	2.0		
I_{GM} Max. peak positive gate current	1.5	A	$T_J = T_J \text{ max.}$
$-V_{GM}$ Maximum peak negative gate voltage	10	V	$T_J = T_J \text{ max.}$
I_{GT} DC gate current required to trigger	90	mA	$T_J = -65^\circ C$
	60		$T_J = 25^\circ C$
	35		$T_J = 125^\circ C$
V_{GT} DC gate voltage required to trigger	3.0	V	$T_J = -65^\circ C$
	2.0		$T_J = 25^\circ C$
	1.0		$T_J = 125^\circ C$
I_{GD} DC gate current not to trigger	2.0	mA	$T_J = T_J \text{ max.}$, $V_{DRM} = \text{rated value}$
V_{GD} DC gate voltage not to trigger	0.2	V	$T_J = T_J \text{ max.}$ Max. gate current/ voltage not to trigger is the max. value which will not trigger any unit with rated V_{DRM} anode-to-cathode applied $V_{DRM} = \text{rated value}$

25RIA Series

Bulletin I2402 rev. A 07/00

International
IRF Rectifier

Thermal and Mechanical Specification

Parameter	25RIA	Units	Conditions	
T _J Max. operating temperature range	- 65 to 125	°C		
T _{stg} Max. storage temperature range	- 65 to 125	°C		
R _{thJC} Max. thermal resistance, junction to case	0.75	K/W	DC operation	
R _{thCS} Max. thermal resistance, case to heatsink	0.35	K/W	Mounting surface, smooth, flat and greased	
T Mounting torque	to nut	to device		
	20(27.5)	25		lbf-in
	0.23(0.32)	0.29		kgf.m
	2.3(3.1)	2.8		Nm
wt Approximate weight	14 (0.49)	g (oz)		
Case style	TO-208AA (TO-48)		See Outline Table	

ΔR_{thJC} Conduction

(The following table shows the increment of thermal resistance R_{thJC} when devices operate at different conduction angles than DC)

Conduction angle	Sinusoidal conduction	Rectangular conduction	Units	Conditions
180°	0.17	0.13	K/W	T _J = T _J max.
120°	0.21	0.22		
90°	0.27	0.30		
60°	0.40	0.42		
30°	0.69	0.70		

Ordering Information Table

Device Code
<div style="display: flex; justify-content: center; gap: 10px;"> <div style="border: 1px solid black; padding: 5px; background-color: black; color: white;">25</div> <div style="border: 1px solid black; padding: 5px; background-color: black; color: white;">RIA</div> <div style="border: 1px solid black; padding: 5px; background-color: black; color: white;">160</div> <div style="border: 1px solid black; padding: 5px; background-color: black; color: white;">M</div> <div style="border: 1px solid black; padding: 5px; background-color: black; color: white;">S90</div> </div> <div style="display: flex; justify-content: center; gap: 10px; margin-top: 5px;"> ① ② ③ ④ ⑤ </div>
<p>1 - Current code</p> <p>2 - Essential part number</p> <p>3 - Voltage code: Code x 10 = V_{RRM} (See Voltage Rating Table)</p> <p>4 - None = Stud base TO-208AA (TO-48) 1/4" 28UNF-2A M = Stud base TO-208AA (TO-48) M6 X 1</p> <p>5 - Critical dv/dt: None = 300V/μs (Standard value) S90 = 1000V/μs (Special selection)</p>

Outline Table

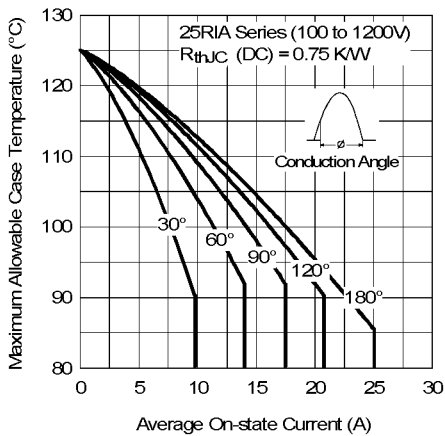
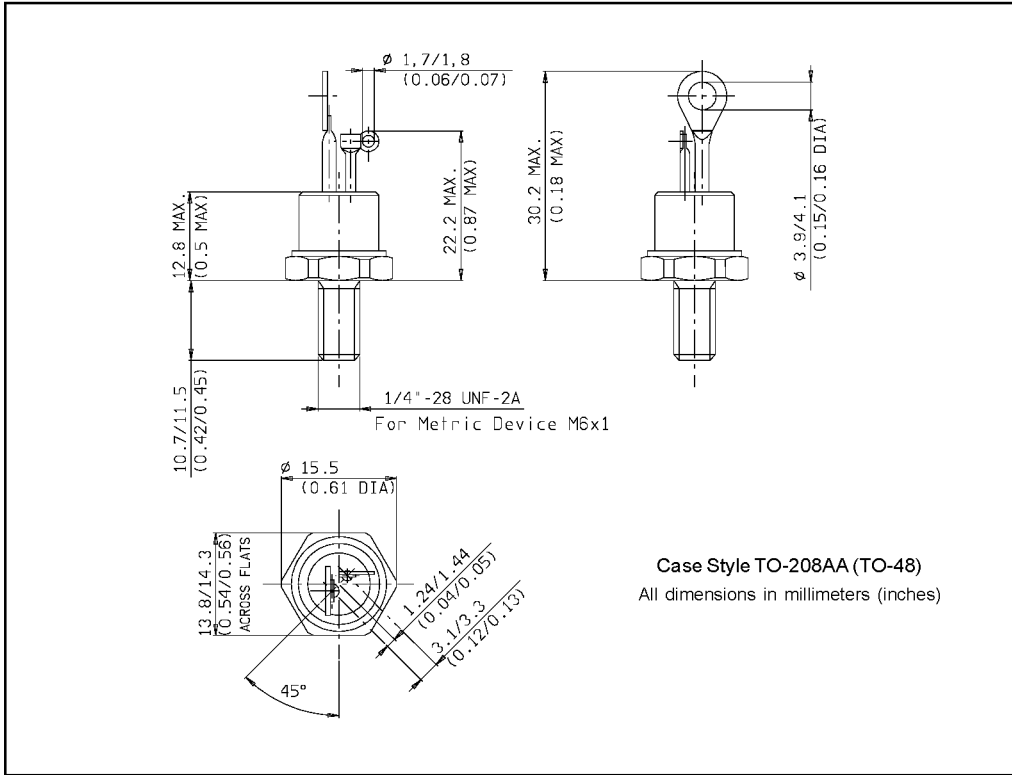

Fig. 1 - Current Ratings Characteristic

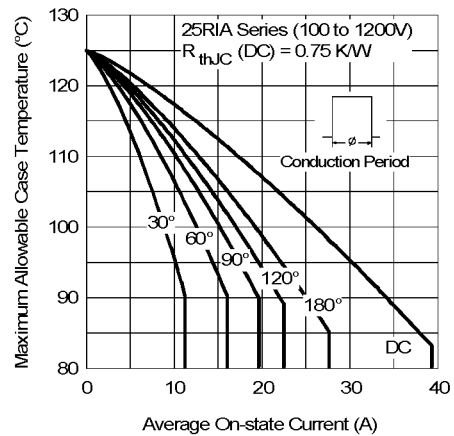

Fig. 2 - Current Ratings Characteristic

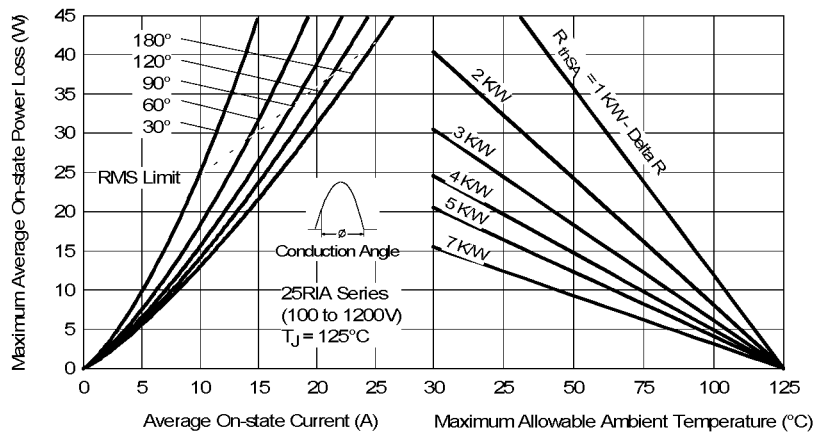

Fig. 3 - On-state Power Loss Characteristics

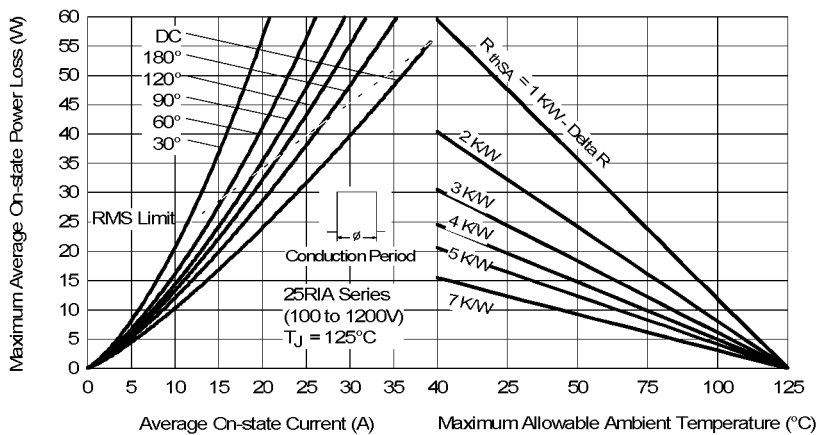

Fig. 4 - On-state Power Loss Characteristics

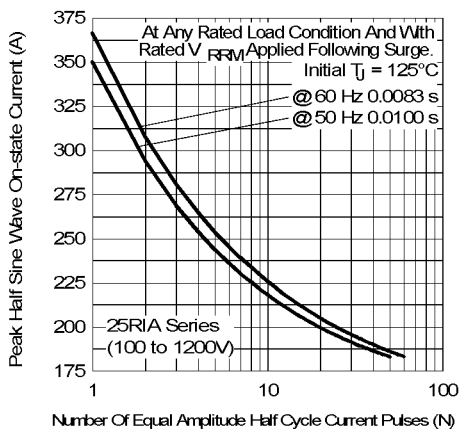

Fig. 5 - Maximum Non-Repetitive Surge Current

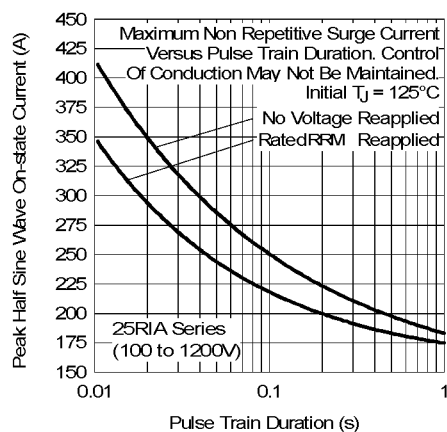

Fig. 6 - Maximum Non-Repetitive Surge Current

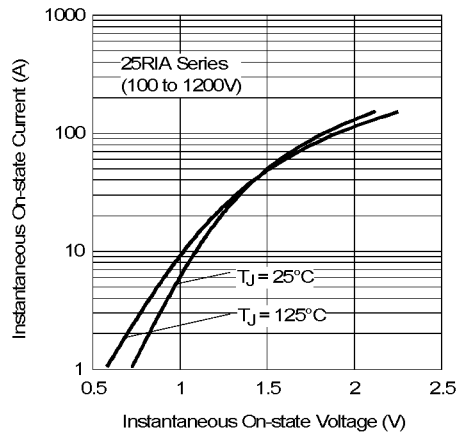

Fig. 7 - Forward Voltage Drop Characteristics

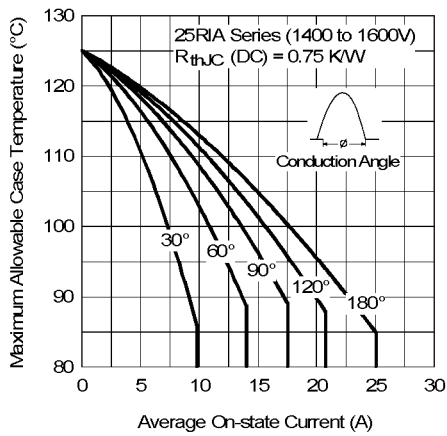

Fig. 8 - Current Ratings Characteristics

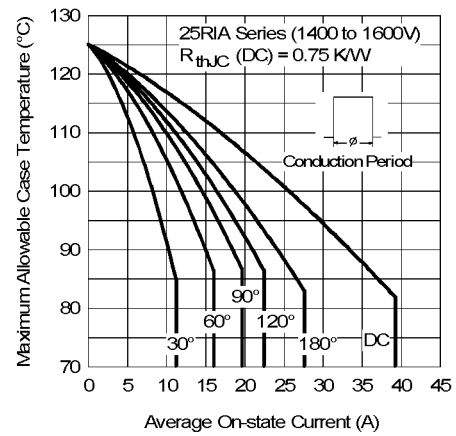

Fig. 9 - Current Ratings Characteristics

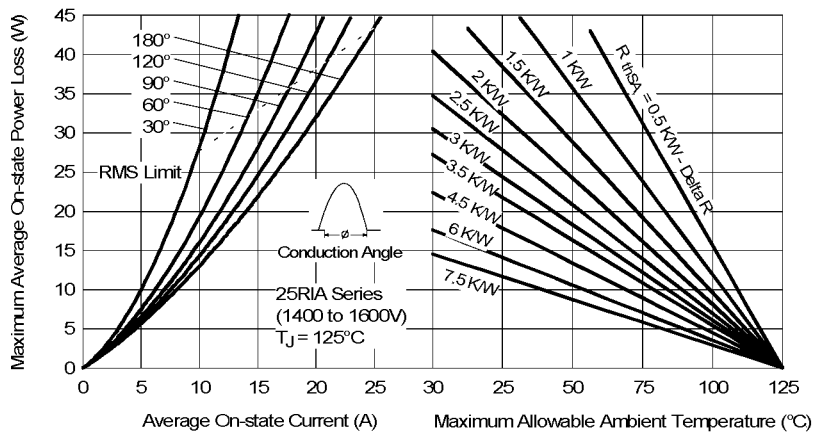

Fig. 10 - On-state Power Loss Characteristics

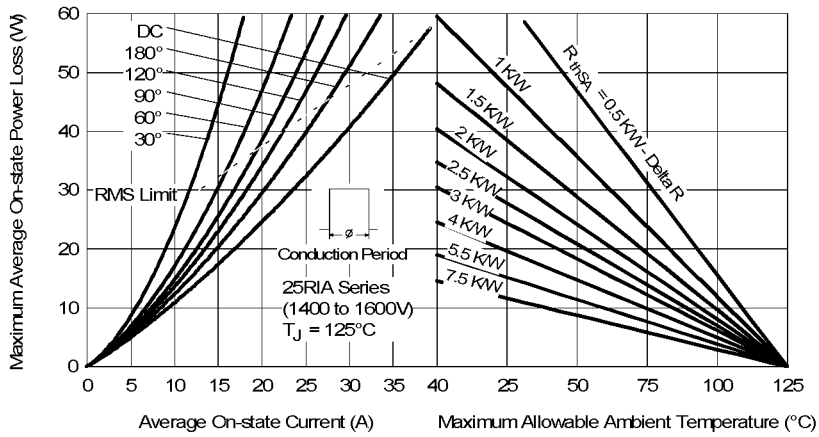

Fig. 11 - On-state Power Loss Characteristics

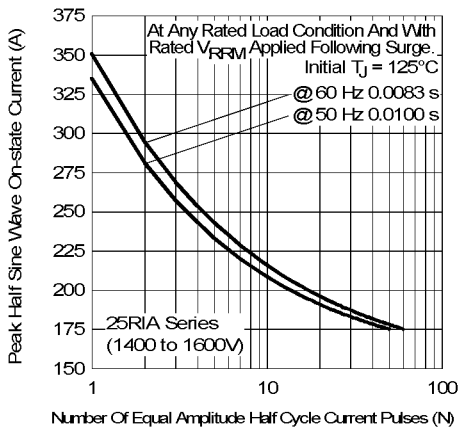

Fig. 12 - Maximum Non-Repetitive Surge Current

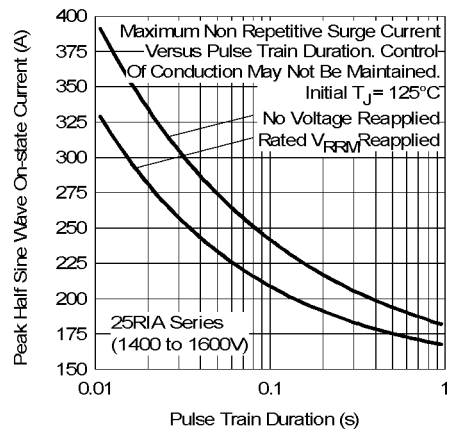

Fig. 13 - Maximum Non-Repetitive Surge Current

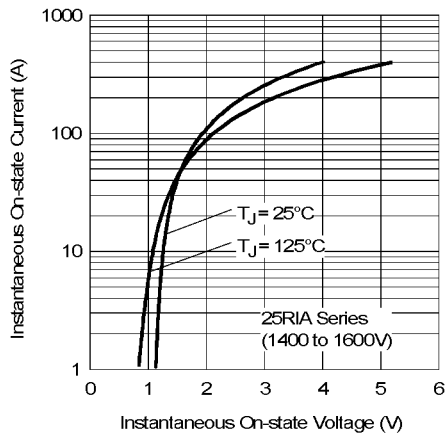

Fig. 14 - Forward Voltage Drop Characteristics

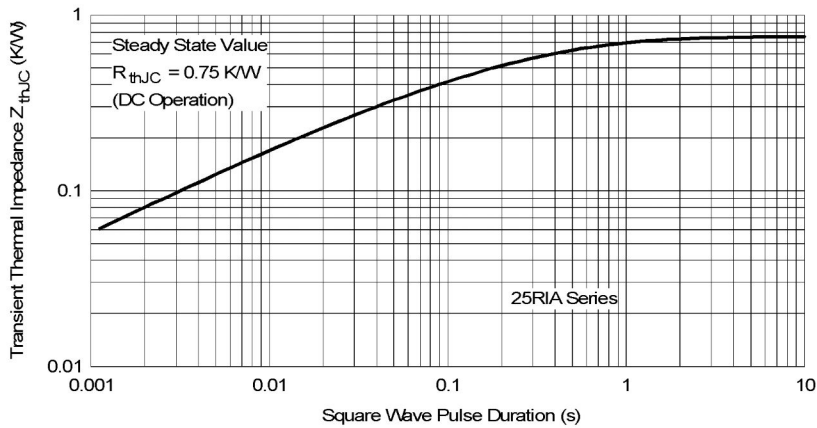

Fig. 15 - Thermal Impedance Z_{thJC} Characteristics

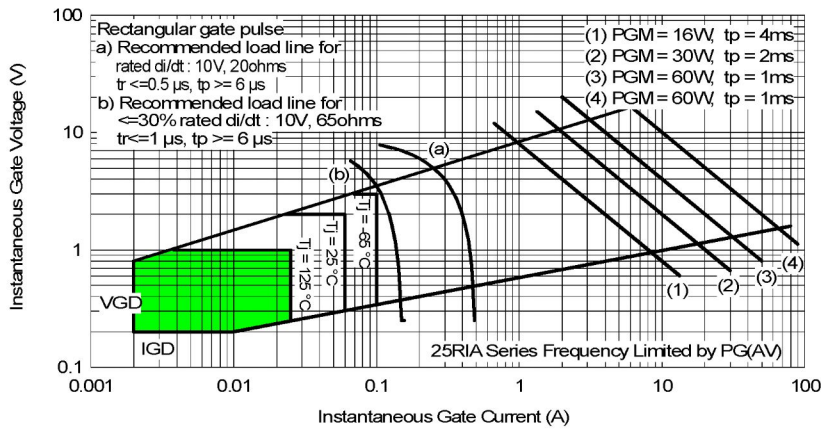

Fig. 16 - Gate Characteristics