

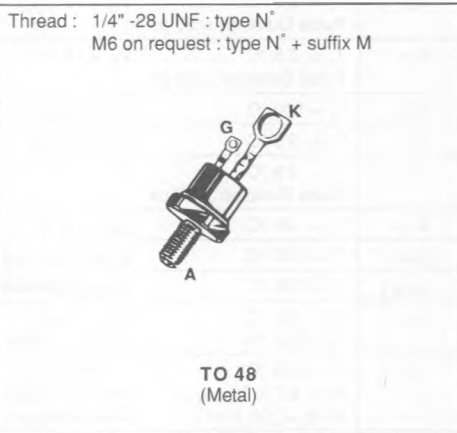

FAST SWITCHING THYRISTORS

- GLASS PASSIVATED CHIP
- HIGH STABILITY AND RELIABILITY
- HIGH di/dt AND dv/dt RATINGS
- $t_q \leq 15 \mu\text{s}$



DESCRIPTION

SCR designed for high frequency power switching applications.

ABSOLUTE RATINGS (limiting values)

Symbol	Parameter	Value	Unit
$I_{T(RMS)}$	RMS on-state Current (1)	$T_C = 40 \text{ }^\circ\text{C}$ 35	A
$I_{T(AV)}$	Mean on-state Current (1)	$T_C = 40 \text{ }^\circ\text{C}$ 22.5	A
I_{TSM}	Non Repetitive Surge Peak on-state Current (T_j initial $\leq 120 \text{ }^\circ\text{C}$) (2)	$t = 8.3 \text{ ms}$	210
		$t = 10 \text{ ms}$	200
I^2t	I^2t Value for Fusing	$t = 10 \text{ ms}$ 200	A^2s
di/dt	Critical Rate of Rise of on-state Current (3)	400	$\text{A}/\mu\text{s}$
T_{stg} T_j	Storage and Operating Junction Temperature Range	- 65 to 150 - 65 to 120	$^\circ\text{C}$

Symbol	Parameter	2N 36..					Unit
		49	50	51	52	53	
V_{DRM} V_{RRM}	Repetitive Peak off-state Voltage (4)	50	100	200	300	400	V

(1) Single phase circuit, 180° conduction angle

(2) Half sine wave

(3) $I_G = 1 \text{ A}$ $di_G/dt = 1 \text{ A}/\mu\text{s}$

(4) $T_j = 120 \text{ }^\circ\text{C}$

THERMAL RESISTANCES

Symbol	Parameter	Value	Unit
$R_{th(j-c)}$	Junction-case for D.C.	1.45	$^\circ\text{C}/\text{W}$
$R_{th(c-h)}$	Contact (case to heatsink)	0.40	$^\circ\text{C}/\text{W}$

GATE CHARACTERISTICS (maximum values)

$P_{GM} = 60 \text{ W}$ ($t_p = 500 \mu\text{s}$)

$I_{FGM} = 10 \text{ A}$ ($t_p = 500 \mu\text{s}$)

$V_{RGM} = 5 \text{ V}$

$P_{G(AV)} = 1 \text{ W}$

$V_{FGM} = 15 \text{ V}$ ($t_p = 500 \mu\text{s}$)

ELECTRICAL CHARACTERISTICS

Symbol	Test Conditions			Min.	Typ.	Max.	Unit
I_{GT}	$T_j = 25 \text{ }^\circ\text{C}$ Pulse Duration > 20 μs	$V_D = 12 \text{ V}$	$R_L = 33 \text{ } \Omega$			180	mA
V_{GT}	$T_j = 25 \text{ }^\circ\text{C}$ Pulse Duration > 20 μs	$V_D = 12 \text{ V}$	$R_L = 33 \text{ } \Omega$			1.5	V
V_{GD}	$T_j = 120 \text{ }^\circ\text{C}$	$V_D = V_{DRM}$	$R_L = 3.3 \text{ k}\Omega$	0.2			V
I_H	$T_j = 25 \text{ }^\circ\text{C}$	$I_T = 500 \text{ mA}$	Gate Open		70		mA
I_L	$T_j = 25 \text{ }^\circ\text{C}$ Pulse Duration > 20 μs	$V_D = 12 \text{ V}$	$I_G = 360 \text{ mA}$		140		mA
V_{TM}	$T_j = 25 \text{ }^\circ\text{C}$	$I_{TM} = 25 \text{ A}$	$t_p = 10 \text{ ms}$			2.05	V
I_{DRM}	$T_j = 120 \text{ }^\circ\text{C}$	V_{DRM} Specified				6	mA
I_{RRM}	$T_j = 120 \text{ }^\circ\text{C}$	V_{RRM} Specified				6	mA
t_{g1}	$T_j = 25 \text{ }^\circ\text{C}$ $I_G = 500 \text{ mA}$	$V_D = V_{DRM}$ $di_G/dt = 5 \text{ A}/\mu\text{s}$	$I_T = 25 \text{ A}$		1		μs
t_q	$T_j = 120 \text{ }^\circ\text{C}$ $V_D = 67 \% V_{DRM}$ $dv/dt = 200 \text{ V}/\mu\text{s}$	$I_T = 25 \text{ A}$ $di/dt = 5 \text{ A}/\mu\text{s}$ Gate Open	$V_R = 15 \text{ V}$			15	μs
dv/dt^*	$T_j = 120 \text{ }^\circ\text{C}$ Linear Slope up to $V_D = 67 \% V_{DRM}$	Gate Open		200			V/ μs

* For higher guaranteed values, please consult us.

PACKAGE MECHANICAL DATA

TO 48 Metal

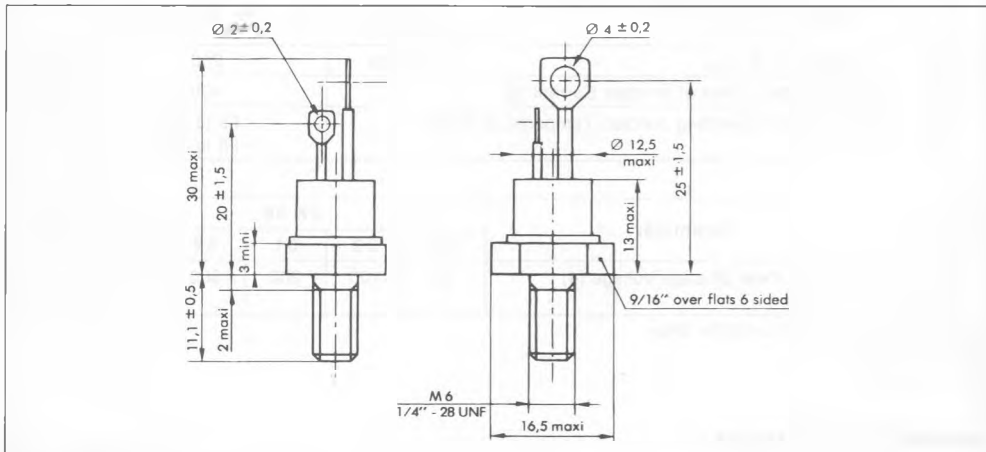

Cooling method : by conduction (method C)

Marking : type number

Weight : 13.5 ± 1 g

Polarity : anode to case

Stud torque : 3.5 mAN min - 3.8 mAN max.

SINUSOIDAL CURRENT PULSE DATA

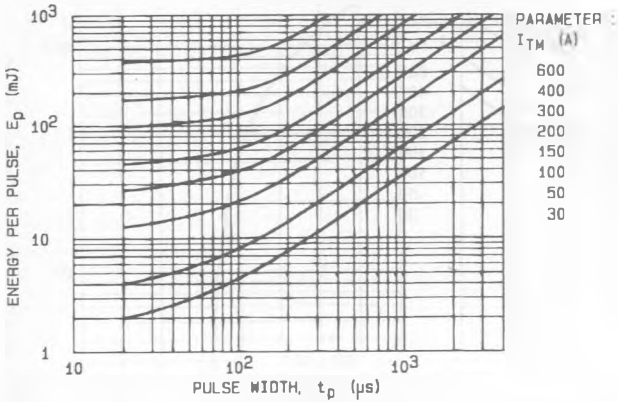

FIG.1 - ENERGY PER PULSE FOR SINUSOIDAL PULSES.

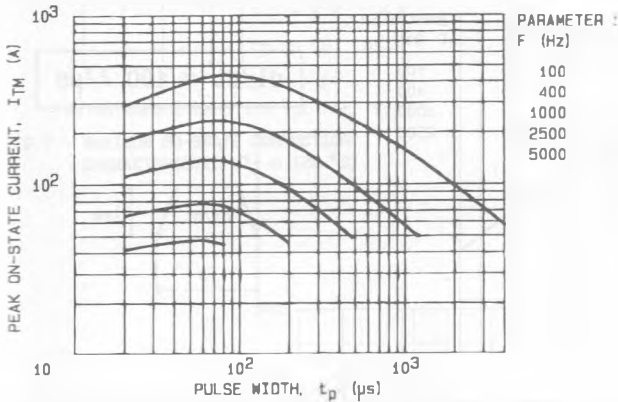

FIG.2 - MAXIMUM ALLOWABLE PEAK ON-STATE CURRENT VERSUS PULSE WIDTH FOR $T_a = 88^\circ\text{C}$.

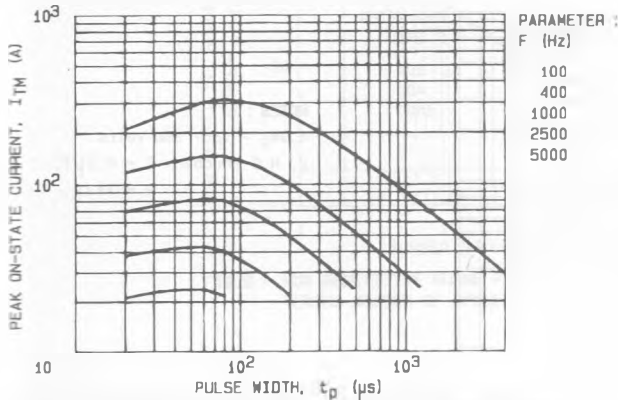
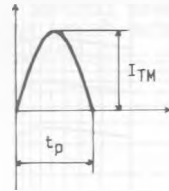

FIG.3 - MAXIMUM ALLOWABLE PEAK ON-STATE CURRENT VERSUS PULSE WIDTH FOR $T_c = 80^\circ\text{C}$.

NOTES :

1. $V_D = V_R = 200$ Volts.
2. R.C Snubber, $C = 0.1 \mu\text{F}$,
 $R = 33 \Omega$.

TRAPEZOIDAL CURRENT PULSE DATA

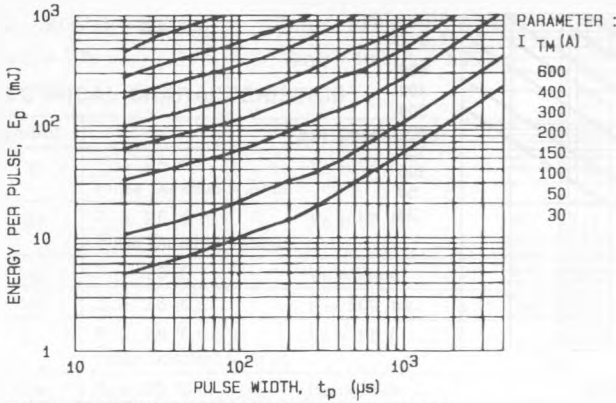

FIG.4 - ENERGY PER PULSE FOR TRAPEZOIDAL PULSES.

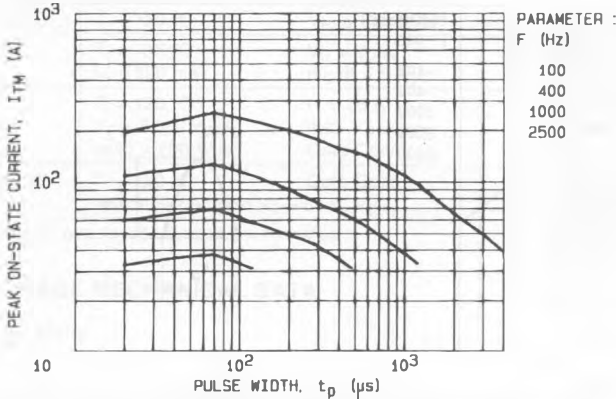

FIG.5 - MAXIMUM ALLOWABLE PEAK ON-STATE CURRENT VERSUS PULSE WIDTH FOR $T_c = 85^\circ\text{C}$.

$di/dt = 100 \text{ A}/\mu\text{s}$

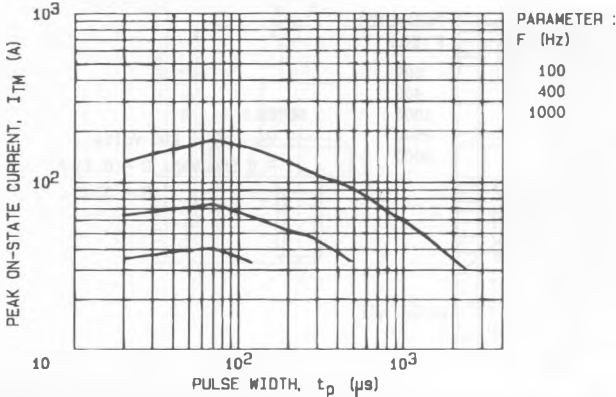
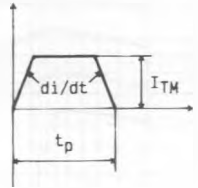

FIG.8 - MAXIMUM ALLOWABLE PEAK ON-STATE CURRENT VERSUS PULSE WIDTH FOR $T_c = 80^\circ\text{C}$.

NOTES :

1. $V_D = V_R = 200$ Volts.
2. R.C Snubber, $C = 0.1 \mu\text{F}$.
 $R = 33 \Omega$.

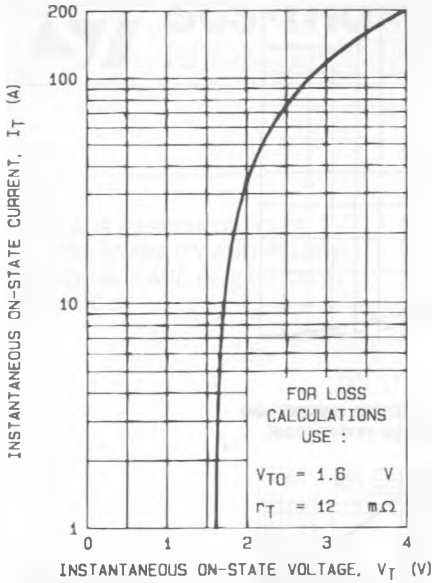

FIG.7 - MAXIMUM ON-STATE CONDUCTION CHARACTERISTIC ($T_J = 120^\circ\text{C}$).

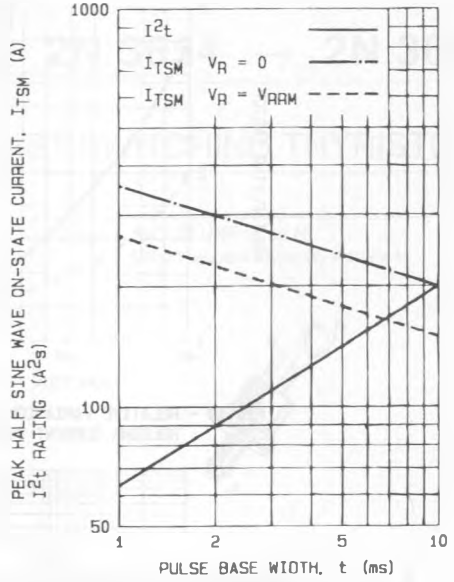

FIG.8 - NON REPETITIVE SUB-CYCLE SURGE ON-STATE CURRENT AND I^2t RATING (INITIAL $T_J = 120^\circ\text{C}$).

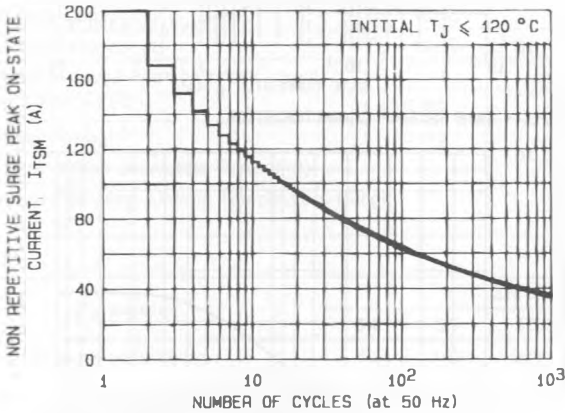

FIG.9 - NON REPETITIVE SURGE PEAK ON-STATE CURRENT VERSUS NUMBER OF CYCLES.

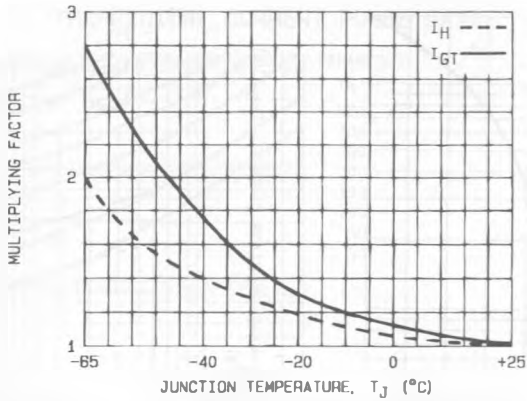

FIG.10 - RELATIVE VARIATION OF GATE TRIGGER CURRENT AND HOLDING CURRENT VERSUS JUNCTION TEMPERATURE.

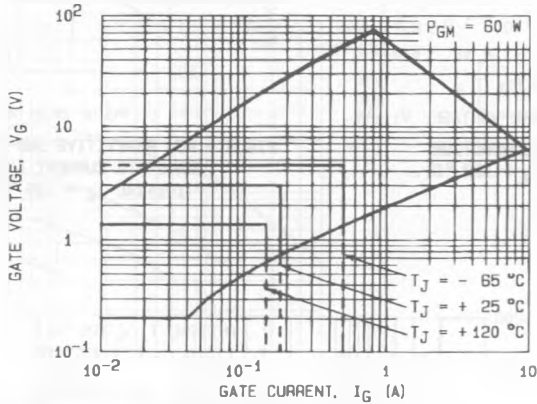

FIG.11 - GATE TRIGGER CHARACTERISTICS.

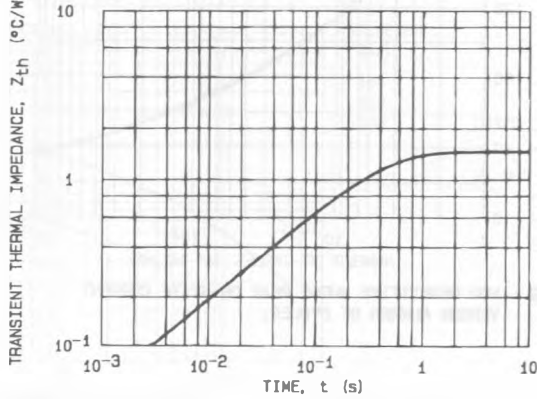

FIG.12 - TRANSIENT THERMAL IMPEDANCE JUNCTION TO CASE.