

FG3000DV-90DA

HIGH POWER INVERTER USE
PRESS PACK TYPE

FG3000DV-90DA



- ITQRM Repetitive controllable on-state current 3000A
- IT(AV) Average on-state current 950A
- VDRM Repetitive peak off state voltage 4500V
- Anode short type

OUTLINE DRAWING

Dimensions in mm

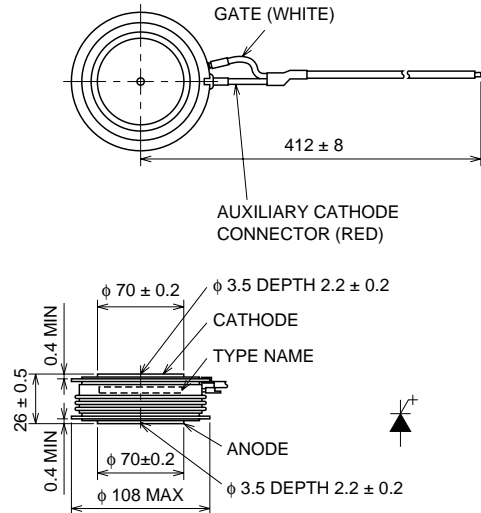

APPLICATION

Inverters, D.C. choppers, Induction heaters, D.C. to D.C. converters.

MAXIMUM RATINGS

Symbol	Parameter	Voltage class		Unit
		90DA		
VRRM	Repetitive peak reverse voltage	17		V
VRSM	Non-repetitive peak reverse voltage	17		V
VR(DC)	DC reverse voltage	17		V
VDRM	Repetitive peak off-state voltage*	4500		V
VD(SM)	Non-repetitive peak off-state voltage*	4500		V
VD(DC)	DC off-state voltage*	2500		V

* : VGK = -2V

Symbol	Parameter	Conditions	Ratings	Unit
ITQRM	Repetitive controllable on-state current	V _{DM} = 3375V, T _j = 125°C, C _S = 6.0μF, L _S = 0.3μH	3000	A
IT(RMS)	RMS on-state current		1490	A
IT(AV)	Average on-state current	f = 60Hz, sine wave θ = 180°, T _i = 71°C	950	A
ITSM	Surge (non-repetitive) on-state current	One half cycle at 60Hz	17	kA
I ² t	Current-squared, time integration	One cycle at 60Hz	1.2 × 10 ⁶	A ² s
diT/dt	Critical rate of rise of on-state current	V _D = 2250V, I _{GM} = 40A, T _j = 125°C	500	A/μs
VFGM	Peak forward gate voltage		10	V
VRGM	Peak reverse gate voltage		17	V
IFGM	Peak forward gate current		100	A
IRGM	Peak gate reverse current		900	A
PFGM	Peak forward gate power dissipation		400	W
PRGM	Peak reverse gate power dissipation		27	kW
PFG(AV)	Average forward gate power dissipation		100	W
PRG(AV)	Average reverse gate power dissipation		230	W
T _j	Junction temperature		-40 ~ +125	°C
T _{stg}	Storage temperature		-40 ~ +150	°C
—	Mounting force required	Recommended value 33	30 ~ 40	kN
—	Weight	Standard value	1220	g

FG3000DV-90DA

HIGH POWER INVERTER USE
PRESS PACK TYPE

ELECTRICAL CHARACTERISTICS

Symbol	Parameter	Test conditions	Limits			Unit
			Min	Typ	Max	
V _{TM}	On-state voltage	T _j = 125°C, I _{TM} = 3000A, Instantaneous measurement	—	—	4.0	V
I _{RRM}	Repetitive peak reverse current	T _j = 125°C, V _{RRM} Applied	—	—	300	mA
I _{DRM}	Repetitive peak off-state current	T _j = 125°C, V _{DRM} Applied, V _{GK} = -2V	—	—	150	mA
I _{RG}	Reverse gate current	T _j = 125°C, V _{RG} = 17V	—	—	300	mA
dv/dt	Critical rate of rise of off-state voltage	T _j = 125°C, V _D = 2250V, V _{GK} = -2V	1000	—	—	V/μs
t _{gt}	Turn-on time	T _j = 125°C, I _{TM} = 3000A, I _{GM} = 40A, V _D = 2250V	—	—	10	μs
t _{gq}	Turn-off time	T _j = 125°C, I _{TM} = 3000A, V _{DM} = 3375V, diGQ/dt = -40A/μs V _{RG} = 17V, C _s = 6.0μF, L _s = 0.3μH	—	—	30	μs
I _{GQM}	Peak gate turn-off current		—	670	—	A
V _{GT}	Gate trigger voltage	DC METHOD : V _D = 24V, R _L = 0.1Ω, T _j = 25°C	—	—	1.5	V
I _{GT}	Gate trigger current		—	—	4000	mA
R _{th(j-f)}	Thermal resistance	Junction to fin	—	—	0.015	°C/W

PERFORMANCE CURVES

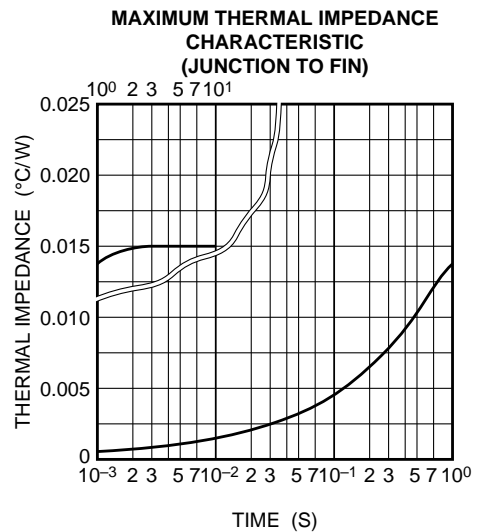
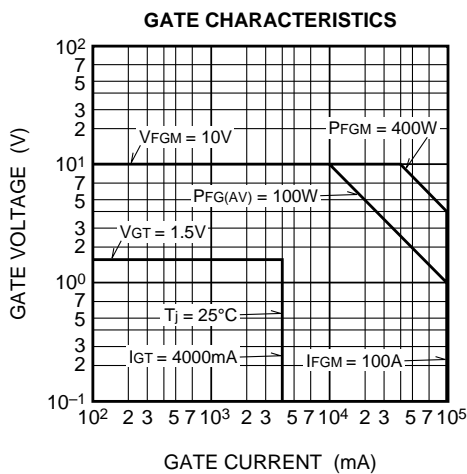
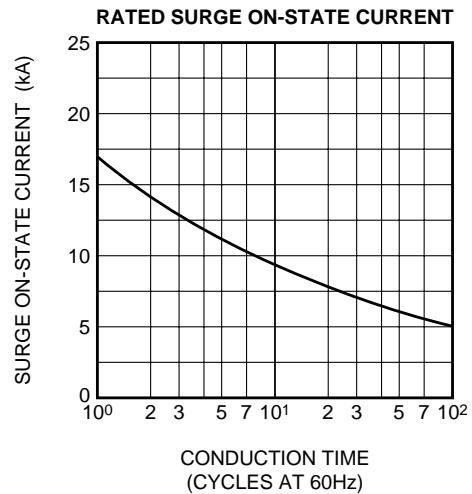
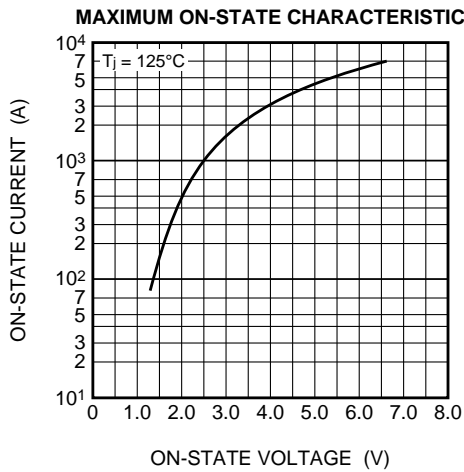

FG3000DV-90DA

HIGH POWER INVERTER USE
PRESS PACK TYPE

MAXIMUM ON-STATE POWER DISSIPATION CHARACTERISTICS (SINGLE-PHASE HALF WAVE)

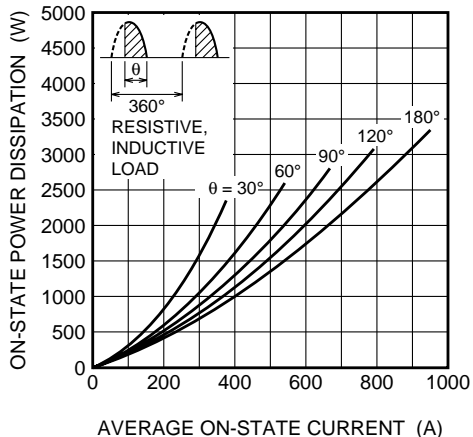

ALLOWABLE FIN TEMPERATURE VS. AVERAGE ON-STATE CURRENT (SINGLE-PHASE HALF WAVE)

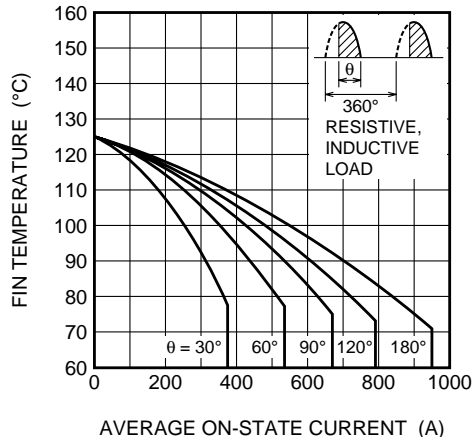

MAXIMUM ON-STATE POWER DISSIPATION CHARACTERISTICS (RECTANGULAR WAVE)

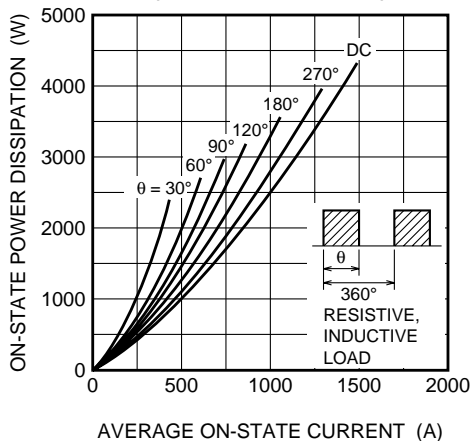

ALLOWABLE FIN TEMPERATURE VS. AVERAGE ON-STATE CURRENT (RECTANGULAR WAVE)

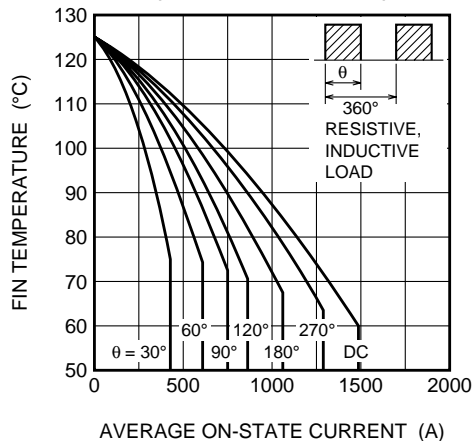

GATE TRIGGER CURRENT VS. JUNCTION TEMPERATURE (TYPICAL)

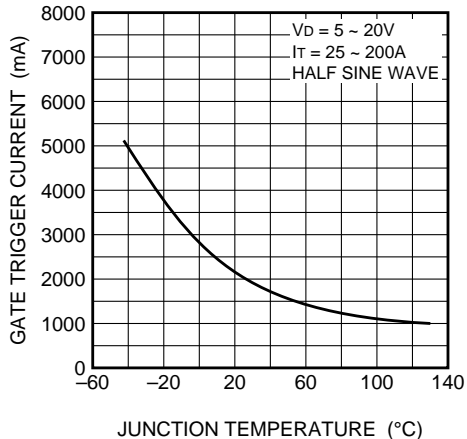

TURN ON TIME, TURN ON DELAY TIME VS. TURN ON GATE CURRENT (TYPICAL)

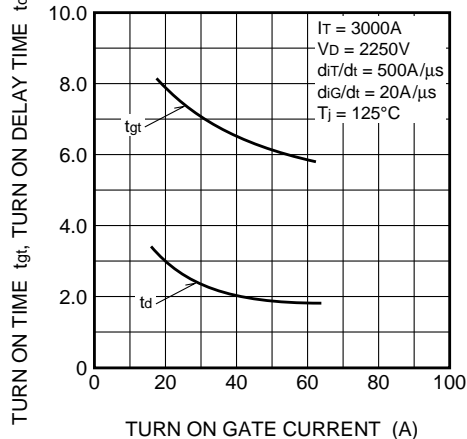

FG3000DV-90DA

HIGH POWER INVERTER USE
PRESS PACK TYPE

