

TOSHIBA THYRISTOR SILICON PLANAR TYPE

SF3G48, SF3J48, USF3G48, USF3J48

MEDIUM POWER CONTROL APPLICATIONS

- Repetitive Peak Off-State Voltage : $V_{DRM} = 400,600V$
 Repetitive Peak Reverse Voltage : $V_{RRM} = 400,600V$
- Average On-State Current : $I_T (AV) = 3A$
- Gate Trigger Current : $I_{GT} = 10mA \text{ MAX.}$

Unit: mm

SF3G48-SF3J48		USF3G48-USF3J48	
<p>1. CATHODE 2. ANODE 3. GATE</p>		<p>1. CATHODE 2. ANODE (BACK SIDE) 3. GATE</p>	
JEDEC	—	JEDEC	—
JEITA	—	JEITA	—
TOSHIBA	13-10J1B	TOSHIBA	13-10J2B

Weight: 1.7g

MARKING

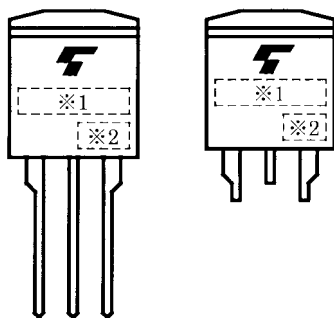

*1	MARK	F3G48	TYPE NAME	SF3G48, USF3G48
		F3J48		SF3J48, USF3J48
*2	Lot Number			
	<div style="display: flex; align-items: center;"> <div style="border: 1px solid black; width: 20px; height: 20px; margin-right: 5px;"></div> <div style="border: 1px solid black; width: 20px; height: 20px; margin-right: 5px;"></div> <div style="margin-left: 5px;">← Month (Starting from Alphabet A)</div> </div> <div style="margin-top: 5px;"> <div style="border: 1px solid black; width: 20px; height: 20px; margin-right: 5px;"></div> <div style="margin-left: 5px;">← Year (Last Decimal Digit of the Current Year)</div> </div>			

MAXIMUM RATINGS

CHARACTERISTIC	SYMBOL	RATING	UNIT
Repetitive Peak Off-State Voltage and Repetitive Peak Reverse Voltage	SF3G48 USF3G48	400	V
	SF3J48 USF3J48	600	
Non-Repetitive Peak Reverse Voltage (Non-Repetitive <5ms, T _j = 0~125°C)	SF3G48 USF3G48	500	V
	SF3J48 USF3J48	720	
Average On-State Current	I _{T (AV)}	3	A
R.M.S On-State Current	I _{T (RMS)}	4.7	A
Peak One Cycle Surge On-State Current (Non-Repetitive)	I _{TSM}	50 (50Hz)	A
		55 (60Hz)	
I ² t Limit Value	I ² t	12.5	A ² s
Critical Rate of Rise of On-State Current (Note 1)	di / dt	100	A / μs
Peak Gate Power Dissipation	P _{GM}	5	W
Average Gate Power Dissipation	P _{G (AV)}	0.5	W
Peak Forward Gate Voltage	V _{FGM}	10	V
Peak Reverse Gate Voltage	V _{RGM}	-5	V
Peak Forward Gate Current	I _{GM}	2	A
Junction Temperature	T _j	-40~125	°C
Storage Temperature Range	T _{stg}	-40~125	°C

Note 1: V_{DRM} = 0.5 × Rated

I_{TM} ≤ 12A

t_{gw} ≥ 10μs

t_{gr} ≤ 250ns

i_{gp} = I_{GT} × 2.0

ELECTRICAL CHARACTERISTICS (Ta = 25°C)

CHARACTERISTIC	SYMBOL	TEST CONDITION	MIN	TYP.	MAX	UNIT
Repetitive Peak Off-State Current and Repetitive Peak Reverse Current	I _{DRM} I _{RDM}	V _{DRM} = V _{RDM} = Rated	—	—	10	μA
Peak On-State Voltage	V _{TM}	I _{TM} = 12A	—	—	1.5	V
Gate Trigger Voltage	V _{GT}	V _D = 6V, R _L = 10Ω	—	—	1.0	V
Gate Trigger Current	I _{GT}		—	—	10	mA
Gate Non-Trigger Voltage	V _{GD}	V _D = Rated × 2 / 3, T _c = 125°C	0.2	—	—	V
Critical Rate of Rise of Off-State Voltage	dv / dt	V _{DRM} = Rated, T _c = 125°C Exponential Rise	—	50	—	V / μs
Holding Current	I _H	V _D = 6V, I _{TM} = 1A	—	—	40	mA
Latching Current	I _L	V _D = 6V, f = 50Hz t _{gw} = 50μs, i _G = 30mA	—	—	50	mA
Thermal Resistance	R _{th (j-c)}	Junction to Case, DC	—	—	3.6	°C / W

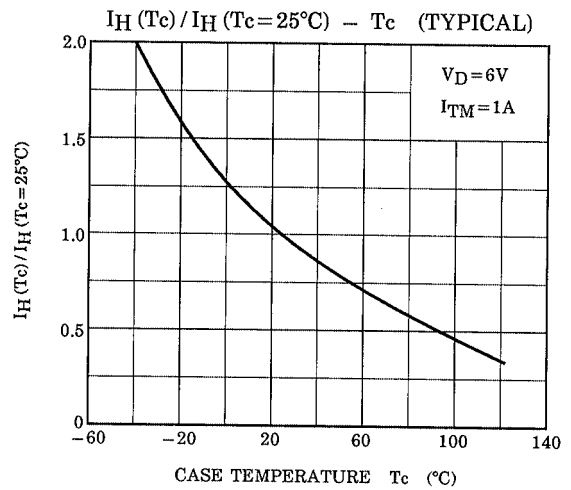
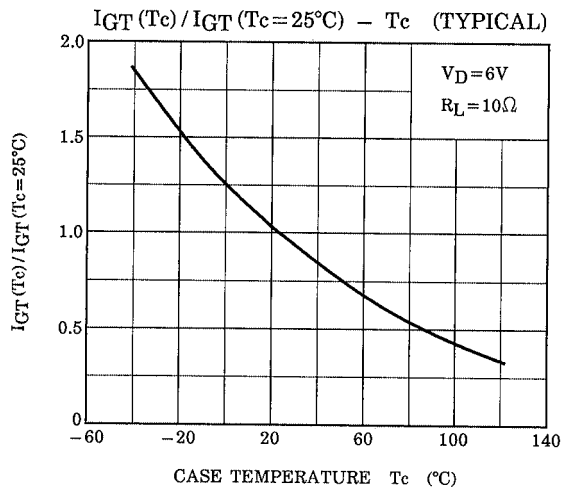
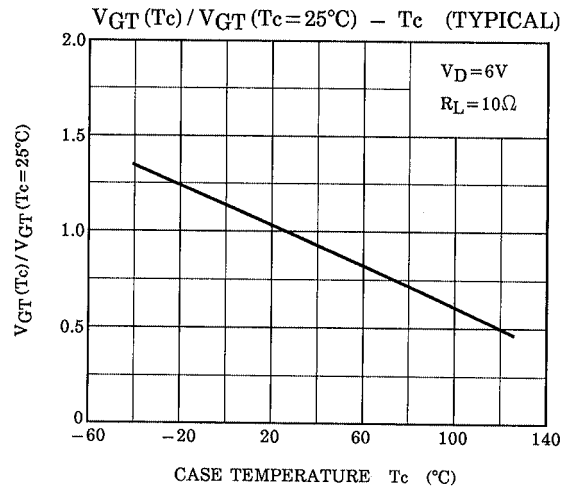
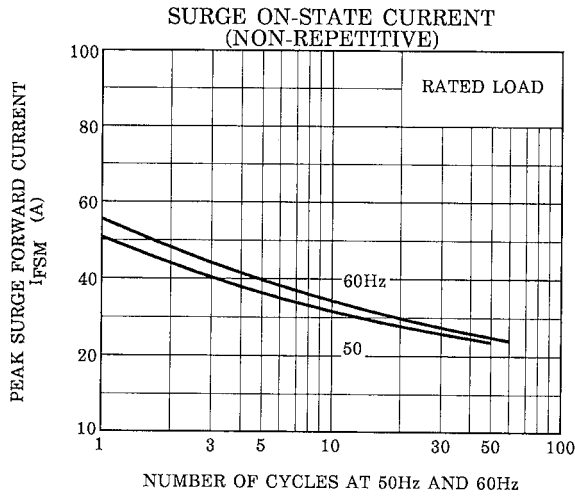
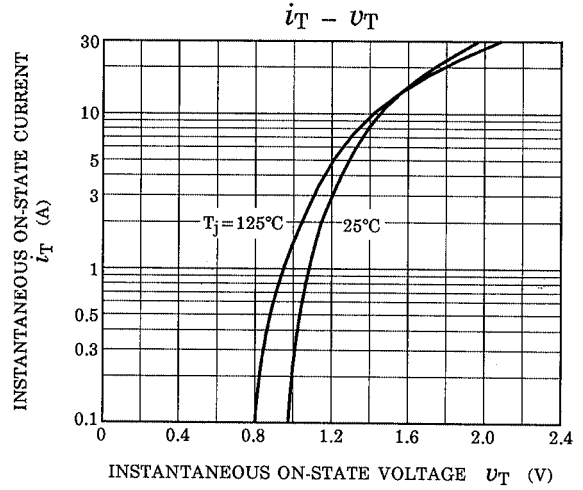
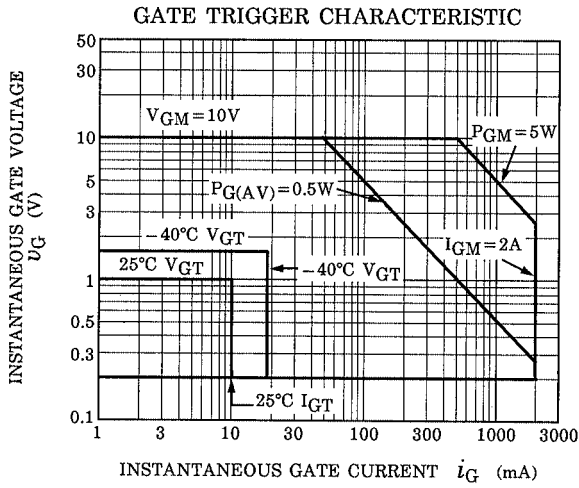

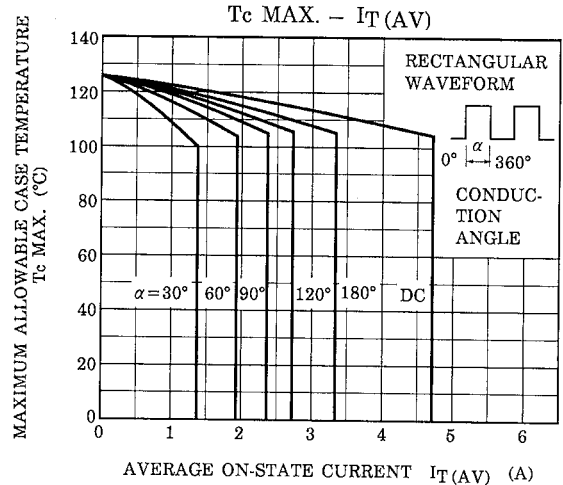
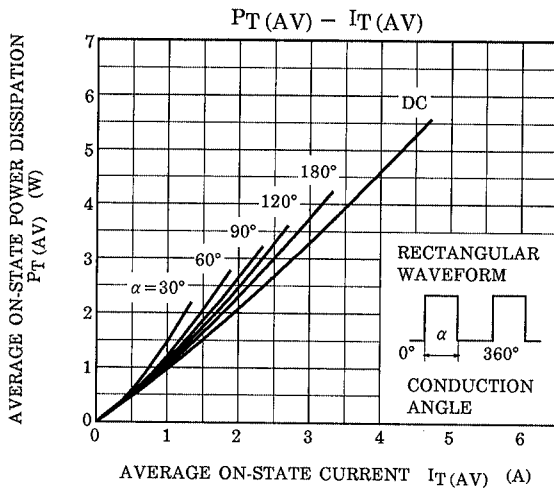
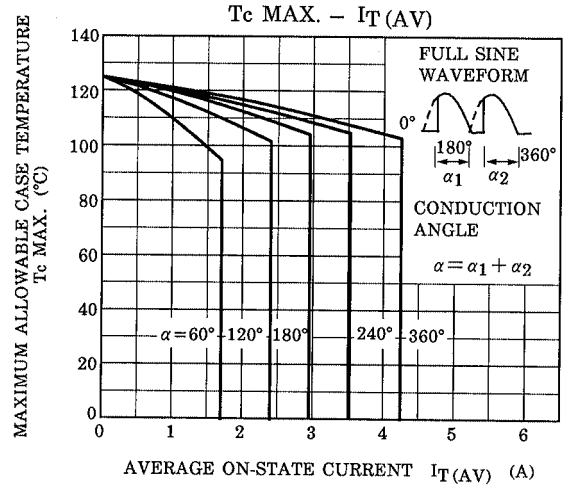
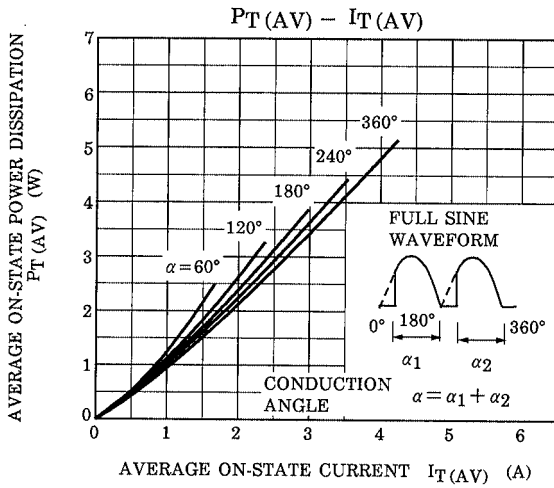
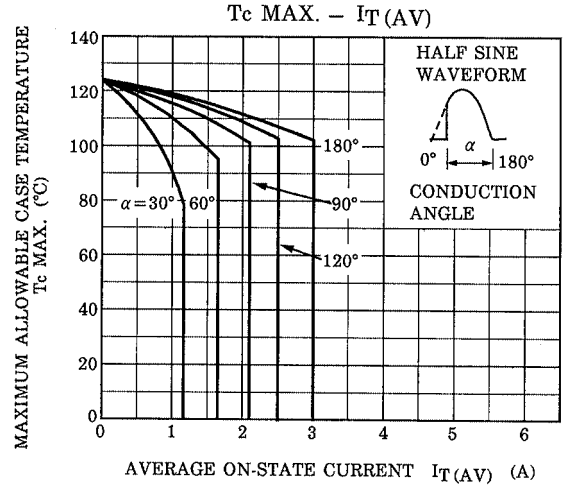
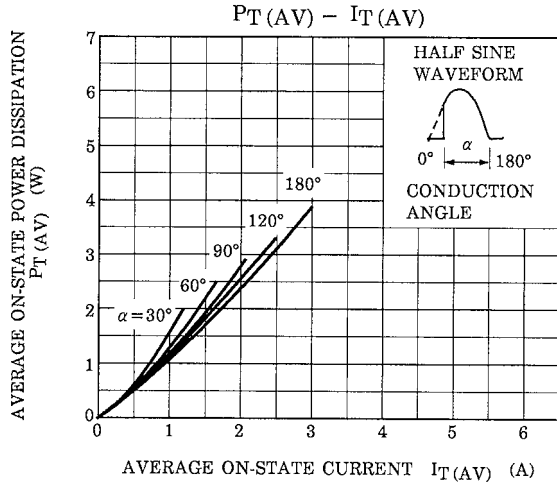

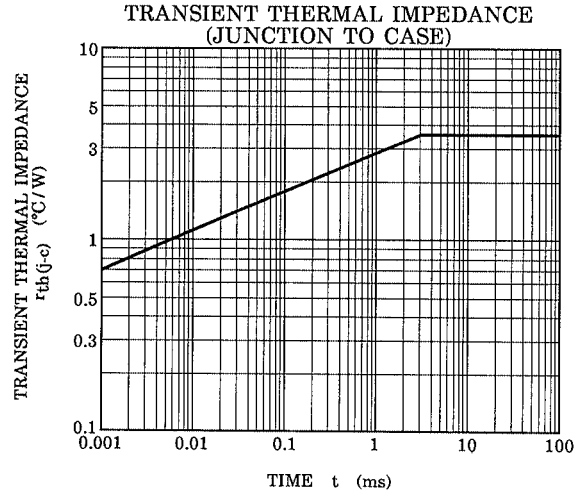
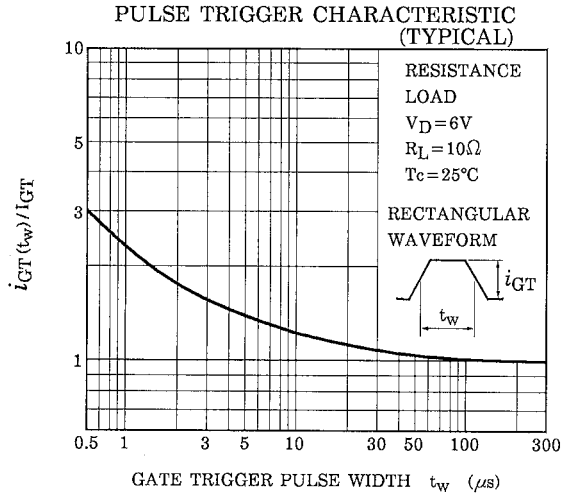

RESTRICTIONS ON PRODUCT USE

000707EAA

- TOSHIBA is continually working to improve the quality and reliability of its products. Nevertheless, semiconductor devices in general can malfunction or fail due to their inherent electrical sensitivity and vulnerability to physical stress. It is the responsibility of the buyer, when utilizing TOSHIBA products, to comply with the standards of safety in making a safe design for the entire system, and to avoid situations in which a malfunction or failure of such TOSHIBA products could cause loss of human life, bodily injury or damage to property.
In developing your designs, please ensure that TOSHIBA products are used within specified operating ranges as set forth in the most recent TOSHIBA products specifications. Also, please keep in mind the precautions and conditions set forth in the "Handling Guide for Semiconductor Devices," or "TOSHIBA Semiconductor Reliability Handbook" etc..
- The TOSHIBA products listed in this document are intended for usage in general electronics applications (computer, personal equipment, office equipment, measuring equipment, industrial robotics, domestic appliances, etc.). These TOSHIBA products are neither intended nor warranted for usage in equipment that requires extraordinarily high quality and/or reliability or a malfunction or failure of which may cause loss of human life or bodily injury ("Unintended Usage"). Unintended Usage include atomic energy control instruments, airplane or spaceship instruments, transportation instruments, traffic signal instruments, combustion control instruments, medical instruments, all types of safety devices, etc.. Unintended Usage of TOSHIBA products listed in this document shall be made at the customer's own risk.
- The information contained herein is presented only as a guide for the applications of our products. No responsibility is assumed by TOSHIBA CORPORATION for any infringements of intellectual property or other rights of the third parties which may result from its use. No license is granted by implication or otherwise under any intellectual property or other rights of TOSHIBA CORPORATION or others.
- The information contained herein is subject to change without notice.