

THYRISTORS FOR OVERVOLTAGE PROTECTION

- GLASS PASSIVATED CHIP
- HIGH STABILITY AND RELIABILITY
- HIGH SURGE CAPABILITY

Thread : 1/4" -28 UNF ; type N°
 M6 on request : type N° + suffix M



TO 48
(Metal)

DESCRIPTION

SCR designed for overvoltage protection in crowbar circuits.

ABSOLUTE RATINGS (limiting values)

Symbol	Parameter		Value	Unit
$I_{T(RMS)}$	RMS on-state Current (1)	$T_c = 75\text{ }^\circ\text{C}$	25	A
$I_{T(AV)}$	Mean on-state Current (1)	$T_c = 75\text{ }^\circ\text{C}$	16	A
I_{TSM}	Non Repetitive Surge Peak on-state Current (T_j initial = $25\text{ }^\circ\text{C}$) (2)	$t = 8.3\text{ ms}$	733	A
		$t = 10\text{ ms}$	700	
I^2t	I^2t Value for Fusing	$t = 10\text{ ms}$	2450	A^2s
I_{TM}	Non Repetitive Surge Peak on-state Current (T_j initial = $25\text{ }^\circ\text{C}$) (5)	$t = 250\text{ ms}$	145	A
di/dt	Critical Rate of Rise of on-state Current (3)		100	$\text{A}/\mu\text{s}$
T_{stg} T_j	Storage and Operating Junction Temperature Range		- 40 to 150 - 40 to 125	$^\circ\text{C}$ $^\circ\text{C}$

Symbol	Parameter	TSP225	TSP525	TSP1025	Unit
V_{DRM} V_{RRM}	Repetitive Peak off-state Voltage (4)	25	50	100	V

(1) Single phase circuit, 180° conduction angle.

(2) Half sine wave.

(3) $I_G = 500\text{ mA}$ $di_G/dt = 1\text{ A}/\mu\text{s}$

(4) $T_j = 125\text{ }^\circ\text{C}$.

(5) Rectangular pulse

THERMAL RESISTANCES

Symbol	Parameter	Value	Unit
$R_{th(j-c)}$	Junction-case for D.C.	2.92	$^\circ\text{C}/\text{W}$
$R_{th(c-h)}$	Contact (case to heatsink)	0.40	$^\circ\text{C}/\text{W}$

GATE CHARACTERISTICS (maximum values)

$P_{GM} = 60 \text{ W}$ ($t_p = 500 \mu\text{s}$)

$I_{FGM} = 10 \text{ A}$ ($t_p = 500 \mu\text{s}$)

$V_{RGM} = 5 \text{ V}$

$P_{G(AV)} = 1 \text{ W}$

$V_{FGM} = 15 \text{ V}$ ($t_p = 500 \mu\text{s}$)

ELECTRICAL CHARACTERISTICS

Symbol	Test Conditions			Min.	Typ.	Max.	Unit
I_{GT}	$T_j = 25 \text{ }^\circ\text{C}$ Pulse Duration > 20 μs	$V_D = 12 \text{ V}$	$R_L = 33 \text{ } \Omega$			50	mA
V_{GT}	$T_j = 25 \text{ }^\circ\text{C}$ Pulse Duration > 20 μs	$V_D = 12 \text{ V}$	$R_L = 33 \text{ } \Omega$			1.5	V
V_{GD}	$T_j = 125 \text{ }^\circ\text{C}$	$V_D = V_{DRM}$	$R_L = 3.3 \text{ k}\Omega$	0.2			V
I_H	$T_j = 25 \text{ }^\circ\text{C}$	$I_T = 500 \text{ mA}$	Gate Open			50	mA
I_L	$T_j = 25 \text{ }^\circ\text{C}$ Pulse Duration > 20 μs	$V_D = 12 \text{ V}$	$I_G = 100 \text{ mA}$		50		mA
V_{TM}	$T_j = 25 \text{ }^\circ\text{C}$	$I_{TM} = 140 \text{ A}$	$t_p = 10 \text{ ms}$			1.5	V
	$T_j = 25 \text{ }^\circ\text{C}$	$I_{TM} = 700 \text{ A}$	$t = 10 \text{ ms}$		4		
I_{DRM}	V_{DRM} Specified			$T_j = 25 \text{ }^\circ\text{C}$		0.01	mA
				$T_j = 125 \text{ }^\circ\text{C}$		10	
I_{RRM}	V_{RRM} Specified			$T_j = 25 \text{ }^\circ\text{C}$		0.01	mA
				$T_j = 125 \text{ }^\circ\text{C}$		10	
t_{gt}	$T_j = 25 \text{ }^\circ\text{C}$ $I_G = 200 \text{ mA}$	$V_D = V_{DRM}$ $di_G/dt = 1.5 \text{ A}/\mu\text{s}$	$I_T = 140 \text{ A}$		1		μs
t_q	$T_j = 125 \text{ }^\circ\text{C}$ $V_D = 67 \% V_{DRM}$ Gate Open	$I_T = 140 \text{ A}$ $di/dt = 30 \text{ A}/\mu\text{s}$	$V_R = 25 \text{ V}$ $dv/dt = 50 \text{ V}/\mu\text{s}$		50		μs
dv/dt^*	$T_j = 125 \text{ }^\circ\text{C}$ Linear Slope up to $V_D = 67 \% V_{DRM}$	Gate Open		200			V/ μs

* For higher guaranteed values, please consult us.

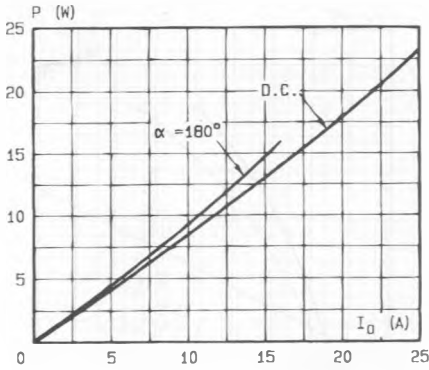

Fig.1 - Maximum average power dissipation versus average on-state current (half sine wave 50 Hz and D.C.).

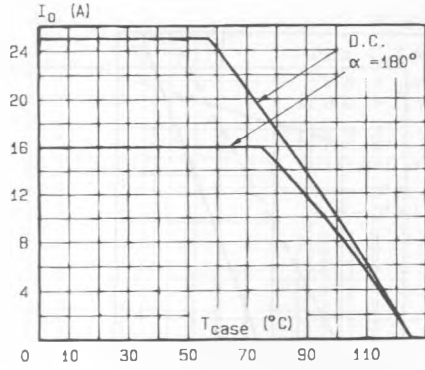

Fig.2 - Maximum average on-state current versus case temperature (half sine wave 50 Hz and D.C.).

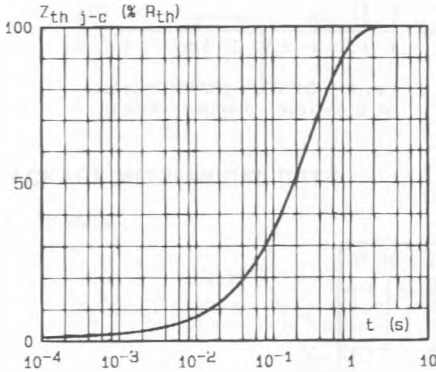

Fig.3 - Thermal transient impedance junction to case versus pulse duration.

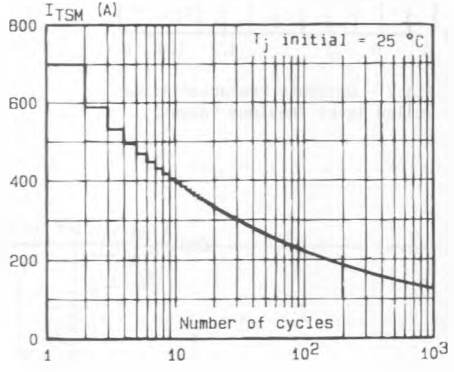

Fig.4 - Non repetitive surge peak on-state current versus number of cycles.

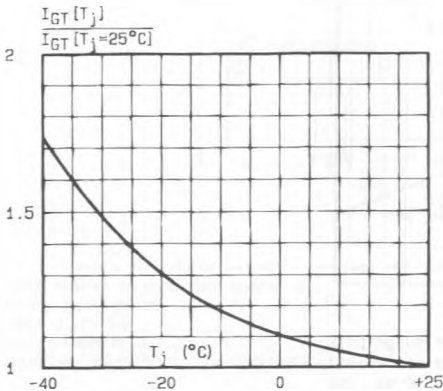

Fig.5 - Relative variation of gate trigger current versus junction temperature.

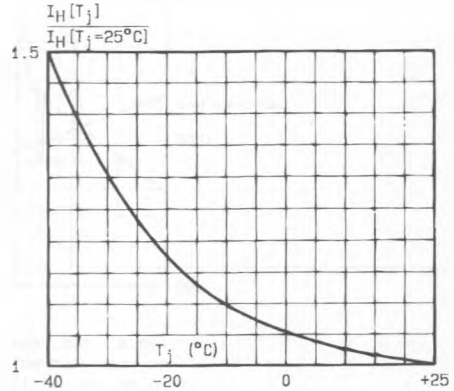

Fig.6 - Relative variation of holding current versus junction temperature.

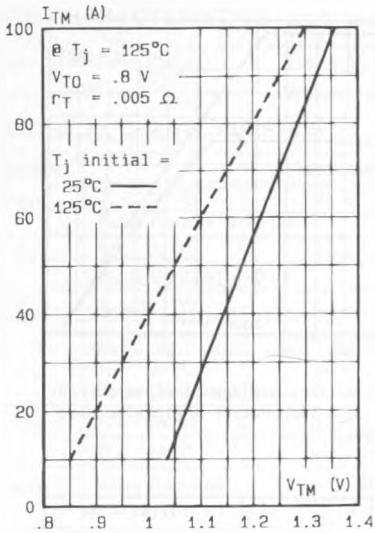

Fig.7 - On-state characteristics at low level (maximum values).

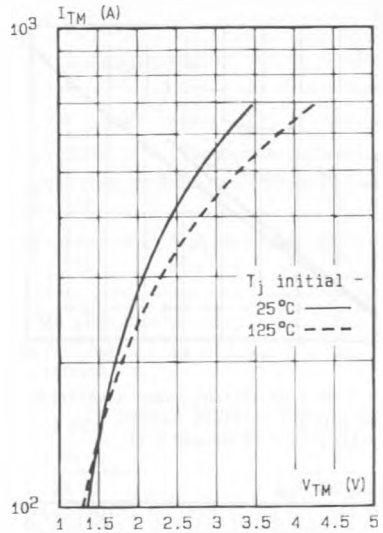

Fig.8 - On-state characteristics at high level (maximum values).

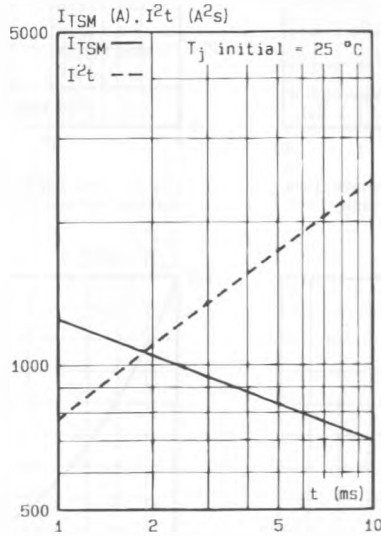

Fig.9 - Non repetitive surge peak on-state current for a sinusoidal pulse with width: $t \leq 10$ ms, and corresponding value of I^2t .

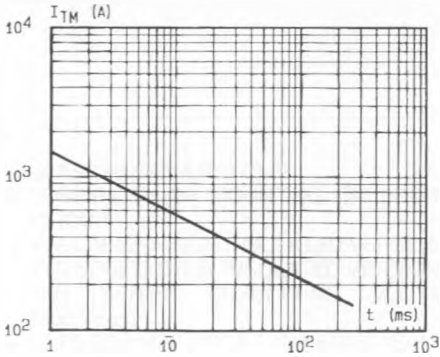

Fig.10 - Peak capacitor discharge current versus pulse width.

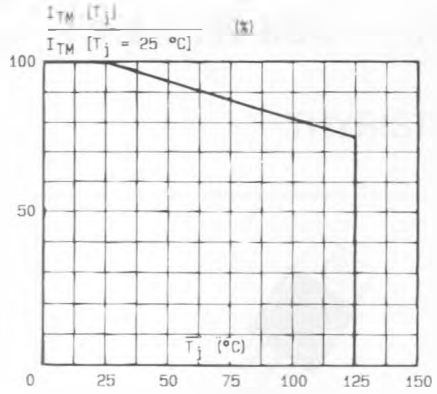
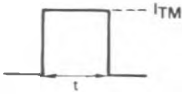
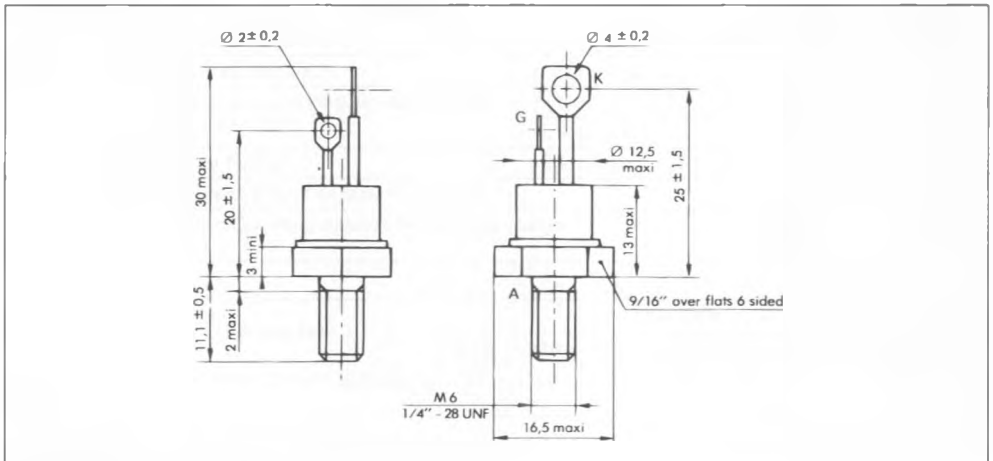

Fig.11 Allowable peak capacitor discharge current versus initial junction temperature.

PACKAGE MECHANICAL DATA

TO 48 Metal



Cooling method : by conduction (method C)
 Marking : type number
 Weight : 13.5 ± 1 g
 Polarity : anode to case
 Stud torque : 3.5 mAN min - 3.8 mAN max